

BIOLOGY
(ZOOLOGY)
Standard XI

Standard XI - Biology (Zoology) Syllabus

Theory

Unit I : **Bio - diversity**

Taxonomic systems : Introduction to Taxa - Species concept - Methods of Taxonomy - Phenetic methods - Identification keys - Cytotaxonomy - Chemotaxonomy - Palaeotaxonomy - Nomenclature methods.

Animal groups : Methods of grouping animals - Major Phyla - General characters with appropriate examples - Protozoa - Porifera - Coelenterata - Platyhelminthes - Aschelminthes - Annelida - Arthropoda - Mollusca - Echinodermata - Chordata.

Type Study : Plasmodium - Earthworm - Pigeon.

Unit II : **Cell Biology**

Introduction : Microscopy and Cytological techniques.

Animal cell - Ultra structure : Plasma membrane - Nucleus - Mitochondria - Ribosomes - Endoplasmic reticulum - Lysosomes - Golgibodies - Centrosomes - Chromosomes.

Cancer Biology : Cancer definition - Types of cancer - Management of cancer.

Unit III : **Human Anatomy**

Human systems : History - The integumentary - Skeletal - Muscular - Digestive - Respiratory - Circulatory - Lymphatic - Nervous - Sense organs - Endocrine - Excretory - Reproductive.

Unit IV : Genetics

Introduction - Multiple alleles - Quantitative inheritance - Sex determination - Sex linked inheritance - Pleiotropy.

Unit V : Developmental Biology

Introduction - Types of eggs - Cleavage and types - Frog's egg - Gastrulation in frog embryo - Organogenesis in frog.

Unit VI : Economic Zoology

Beneficial animals : Corals - Earthworm - Vermiculture - Beneficial insects - Prawns - Lobsters - Crabs - Pearl oysters - Fishes - Guano - Aquarium - Vivarium.

Harmful animals : Disease causing organisms - Vectors - Poisonous organisms - Fouling organisms - Pests.

Unit VII : Origin of life

Theories - Geological time scale - Fossils - Extinct animals - Mass extinction.

Standard XI - Biology (Zoology) Syllabus

Practical

I Earthworm - Mounting of Body setae - minimum 3 setae

II Shark - Mounting of Placoid scales

III Study of parts of a compound microscope and dissection microscope.

Demonstration - Circulation of Blood in the wing of a live cockroach.

IV Prepared slides - observation - drawing and writing notes on

1. Plasmodium - any 2 stages
2. Paramecium - entire, Paramecium - conjugation
3. Hydra - entire
4. Tapeworm - Scolex
5. Amphioxus - entire
6. Shark - Placoid scales

V Museum specimens

Simple sponge, Corals, Tapeworm - entire, Ascaris - entire (male and female), Earthworm - entire, Prawn - entire, Cockroach - Dorsal and ventral views, Apple snail, Star fish, Amphioxus, Shark, Frog, Calotes, A snake, Pigeon, Quill feather, Rat

VI Demonstration only

1. Frog - Buccal cavity, viscera and Digestive system.

VII Human anatomy

1. Upper and lower jaw with dentition
2. Models / actual bones - humerus, radius ulna, femur, tibia, fibula, vertebrae, pelvic girdle

CONTENTS

1. BIODIVERSITY	1
2. CELL BIOLOGY	59
3. HUMAN ANATOMY	85
4. GENETICS	152
5. DEVELOPMENTAL BIOLOGY	168
6. ECONOMIC ZOOLOGY	183
7. ORIGIN OF LIFE	223

1. BIODIVERSITY

Our planet, earth, is occupied by diverse kinds of living organisms. They live in various environments. The world is estimated to have 5 to 30 million species of living organisms. At present about 2.5 million species of living organisms have been given scientific names. Over 1.5 million of them are animal species and out of which 750,000 belong to insect species alone. There are 350,000 species of plants including algae, fungi, mosses and higher forms of plants. Thus the existence of different forms of a species or genus and diverse adaptations for, varied surroundings are referred to as “biodiversity”.

The survival of such a vast range of living beings could be ensured only when their habitats and environmental conditions remain without alterations. The term ‘**biosphere**’ had been coined to highlight the interdependence of living and non-living world. It represents a stable environment of various physical and biological factors which have been operating since the past. The organic continuity of the system rests on a delicate network of interdependent relationships. The air, the water, the animals, the plants, the microbes and human beings are all interlinked in a life sustaining system, called the **environment**.

Safeguarding the entire biosphere with all its intricacies is of prime importance today. The nations of the world have convened several conferences and adopted important resolutions for safeguarding the sustainability of earth. In this background, the United Nation’s ‘Environmental Agency’ organised the “International Conference on Human Environment” at Stockholm in 1972. This conference adopted the motto ‘**Only one earth**’. In 1982, a UN conference on Environment was held at Nairobi. The UN again convened “**Earth summit**” at Rio de Janeiro highlighting “**our common future**”, in 1992. Once again a world summit on **sustainable development** was organised in Johannesburg in 2002. One of the agenda commonly placed and accepted in all these meets was the significance of **biodiversity** and its conservation to ensure sustainable earth.

Biodiversity in India

India’s immense biological diversity represents about 7% of world’s flora and 6.5% of world’s fauna. About 62 % animals in India are endemic to the country. India is one of the 12 countries identified as mega centres of biological diversity.

As per the State Forest Report 1999, based on visual and satellite data from IRS-1B, 1C and 1D, the total forest cover of India is 637,293 sq. km. It is 19.39 % of the total geographic area of the country. It comprises about 64 million hectares.

Indian flora comprises about 15,000 flowering plants of which roughly around 1,500 plant species are threatened. Mammalian fauna of India is 372 species with 63% in Assam. India's 1228 bird species represent about 13% of world's total. Reptilian and amphibian fauna includes 446 and 204 species respectively.

Since the world has a vast range of organisms, identifying the useful, as well as harmful living beings is a need. Differentiating, grouping and giving names to living things has been an ancient activity of every human culture. Without proper classification it would be impossible to deal with enormous diversity of life forms.

1.1 Taxonomic systems

The initiation for evolving taxonomic systems was provided by **Aristotle** (384-322 BC). He emphasized that animals can be classified according to their way of living, actions, habits and body parts. He observed insects, fishes, birds and whales. The insect orders like Coleoptera, Diptera were created by him. Due to his contributions, he is considered as the '**father of biological classification**'.

For modern taxonomy, the first work was carried out by **John Ray** (1627 - 1705) of England. His most interesting systematic work '*Synopsis Methodica Animalium Quadrupedum et Serpentinae Generis*' was published in 1693. He divided animals into those with blood and those without blood. He also classified animals based on gills, lungs, claws, teeth and other structures. He provided the first good definition of the species as 'a reproducing unit'.

The great Swedish naturalist **Linnaeus** (Caroli Linnaei) (1707 - 1778) exerted an important influence on further advancement in taxonomy. Hence he has been called the **father of taxonomy**. In 1758 he published his famous book, **systema naturae**. He first introduced the hierarchic system, both in animal and plant kingdoms. He followed four categories namely **class, order, genus, species** for the animal world. His greatest contribution to taxonomy was the use of **binomial nomenclature** for all species of animals and plants.

Michael Adamson (1727 - 1806), a French botanist, stressed that classification should be based on as many characters as possible. His concept helped to develop a new type of taxonomy called '**Numerical Taxonomy**'.

Lamarck (1744 - 1829) made the first attempt to improve Linnaeus system. He published seven volumes of his '*Histoire Naturelle des Animaux sans Vertebres*'. He arranged animals according to evolution. He displayed the groups of animals in the form of a branching tree. It was the beginning of the use of **phylogeny in systematics**.

Cuvier (1769 - 1832) insisted that extinct fossil forms should be included in the table of classification. He divided animals into four branches. They are **Vertebrata**-fishes to mammals, **Mollusca**-mollusca and barnacles, **Articulata**-annelids, crustaceans, insects and spiders and **Radiata**-echinoderms, nematodes and coelenterates.

Charles Darwin in 1859, published his famous work 'Origin of species'. The new evolutionary concept of Darwin had an immediate acceptance among biologists. Due to the influence of evolutionary ideas, taxonomy was studied as an important evidence in favour of evolution. The taxonomists were encouraged to learn that evolution theory of Darwin gave meaning to their classifying activities. A large number of species were discovered and described.

The development of modern taxonomy started during 1930s. During this period taxonomy was based on **population studies**. E. Mayr (1942) considered species as "groups of interbreeding natural populations". His book 'New Systematics' became a landmark in the history of taxonomy. The taxonomists were forced to accept species as a 'population'. Hence the taxonomist started moving from the laboratory to the field. Morphological characters were studied along with other characters as behaviour, sound, ecology, genetics, zoogeography, physiology and biochemistry. Thus taxonomy was transformed into '**biological taxonomy**'.

1.1.1 Introduction to taxa and species

While grouping or arranging the organisms, a biologist faces three scientific ideas, namely taxonomy, systematics and classification. These disciplines though appear similar have slight deviations in their meaning.

The term **taxonomy** is a Greek word. Its components are *taxis* and *nomos*. While *taxis* means arrangement, *nomos* means law. Thus taxonomy is defined as the "**theory and practice of classifying organisms**" (E. Mayr 1966).

The term **systematics** originates from the Greek word *systema*. It means ‘placing together’. Thus systematics means classification of living things in accordance with their natural relationships. G.G Simpson (1961) defines systematics as follows “**Systematics is the scientific study of the kinds and diversity of organisms and of any and all relationships among them**”.

The term **classification** in meaning partly overlaps with taxonomy. However it simply means the activity of classifying. Thus according to Simpson “**Zoological classification is the ordering of animals into groups on the basis of their relationships**”.

A certain amount of overlap in meaning between the terms systematics, taxonomy and classification is unavoidable.

Taxon.

Based on specific characteristics, animals are grouped in various categories. These categories are otherwise called taxa (singular: taxon). “**A taxon is a taxonomic group of any rank that is sufficiently distinct to be worthy of being assigned to a definite category**”.

The several taxa in animal taxonomy are the **Phylum, Class, Order, Family, Genus** and **Species**. This arrangement from Phylum to Species is designated as the **hierarchic system of classification**. In this system each taxon is based on specific characters of a group of organisms. Eventhough such an arrangement appears to be man made, each taxon is a natural assemblage. However, human error in identification and grouping may happen.

The taxon, ‘**Phylum**’ is the largest group. There are several such Phyla constituting the animal kingdom. Members of a Phylum are recognised by certain distinctive features as shown below.

Characters		Phylum
Single celled animals	-	Protozoa
Pore bearers	-	Porifera
Common body cavity and digestive cavity	-	Coelenterata
Flatworms	-	Platyhelminthes
Thread-like worms	-	Nematoda
Metamerically segmented animal	-	Annelida
Having jointed legs	-	Arthropoda
Soft bodied	-	Mollusca
Spiny skinned	-	Echinodermata
Having notochord	-	Chordata

Apart from one specific character, the members of the Phylum may also show other common characters. Since a Phylum comprises enormous varieties of animals, it is further subdivided as given below

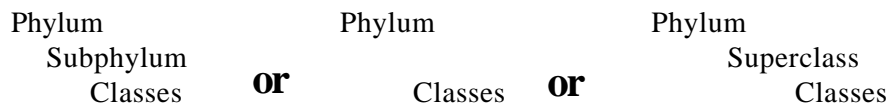

A **Class** is the next level in the hierarchy. There are only few Classes in a Phylum. The members of each Class are identified by some specific character. Thus for example the Phylum : Protozoa comprises four Classes as follows.

Class	Character
Rhizopoda	with root like pseudopodia
Ciliata	having cilia
Flagellata	having flagellum
Sporozoa	producing spores

Each Class may further be divided into Superorders or Orders

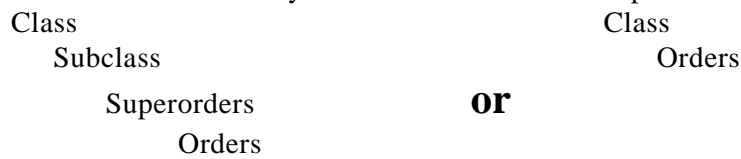

An **Order** is another level in the taxonomic hierarchy. It is marked by some specific feature. A Class may have several Orders. For example, the Class : Insecta is subdivided into nearly 29 Orders. Each Order is identified by a specific character.

Order	Character	Example
Aptera	No wing	Lepisma
Coleoptera	Horny wings	Beetles
Lepidoptera	Scaly wings	Butterflies
Diptera	Two winged	Mosquitoes
Hymenoptera	Membranous wings	Wasps.

The Order is subdivided into Families

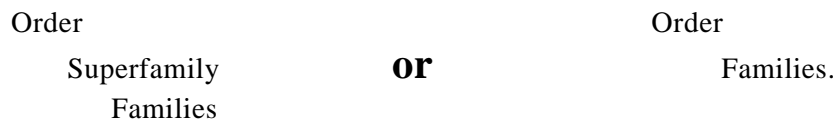

Each **Family** will contain several Genera (singular : Genus). Each **Genus** again is subdivided into **Species**.

In this hierarchy, the Species is considered as the most important taxon. A Species represents a natural unit. All other taxa remain arbitrary and are subjected to revision. A Species is considered a reality. It is the fundamental unit in taxonomy. Evolution basically operates at the Species level only. Hence the **concept of Species** has received much attention.

Concept of Species

Initially the Species was considered as a group of organisms showing similar or specific characters. However modern workers have identified three main concepts regarding Species.

1. **Typological Species concept** - This concept has its beginning from the essentialism concept of Aristotle. According to this concept a Species is recognised by its essential characters expressed in morphology.
2. **Nominalistic Species concept** - According to this concept Species are man made ideas. Nature produces individuals and not Species. Thus a Species is considered as a mental concept.
3. **Biological Species concept** - According to this concept, "Species are groups of interbreeding natural populations that are reproductively isolated from other such groups". This concept is mostly accepted by present day taxonomists.

1.1.2 Methods of taxonomy

Phenetic method or Numerical taxonomy

This method involves clustering or grouping of individuals of a taxon or several taxa. Based on overall similarity, identifications are being made. The desired size of the clusters or groupings is called the **operational taxonomic unit** (OTU).

The identification method involves measurement of taxon to taxon similarity or dissimilarity. It is measured using a scale of 0 to 1. '1' represents perfect identity. '-1' designates dissimilarity between taxa. In this method enormous amount of data are collected for related groups. Analyses are made, using statistical tools and computers.

1.1.3 Cytotaxonomy

The characterization and identification of a cell's complete **chromosome** set is referred to as **karyotyping**. It is the first stage in the

process of using chromosomes in taxonomy.

Karyotypes within interbreeding populations of a species are usually constant. Between species there may be variation in chromosome number and size. Final stages of chromosomal aberrations such as inversions and translocations can give clues regarding intermediary stages.

1.1.4 Chemotaxonomy

Chemotaxonomy refers to the use of information about small molecules produced by the action of enzymes. Protein fractions in electrophoretic techniques, identification of amino acids in chromatography, prevalence of isoenzymes in tissue materials are all tools employed in chemotaxonomy. The occurrence of specific pheromones, colour pigments, toxins also help as keys in taxonomy.

1.1.5 Palaeotaxonomy

This method depends on identification and dating of fossils. Availability of a good complete fossil provides better chance for identification. In several fossils, their sections taken through laborious processes have provided the identification features.

The fossils are normally studied along with other accompanying fossils, its geographic location and other factors. Even though it is possible to assign a fossil to a genus or other higher level, fixing the species is not always possible.

1.1.6 Nomenclature methods

Nomenclature forms the basis by which scientists can name and cross refer to organisms. It is an integral part of taxonomy. In fact, modern taxonomy started in 1753 with the publication of first part of *Systema* by **Linnaeus**. According to Linnaeus a Species is specified by the combination of both its specific and generic names. Since it requires two names, it is referred to as the **binomial system**. This system is now firmly established in Biology.

In modern times International Commissions are responsible for naming each major group of organisms. There are several such commissions. These commissions authorize the usage of scientific names in biology. Naming of animals is monitored by **International Code of Zoological Nomenclature** (ICZN) (International Commission of Zoological Nomenclature, 1985).

The rules are set out in the 'codes'. The codes are modified by occasional science congresses.

Basic principles of nomenclature

1. Providing **stability** in the naming and classification of organisms is emphasized. Any taxon must have only one correct name.
2. If two or more names are already in use the correct name will be the one that was published earlier. This system is referred to as the **law of priority**.
3. If two or more workers at one particular time describe the same organism using different names, it results in **synonyms**. However only one name will be held as a **valid name**. The validity is provided to the senior synonym.(law of priority)
4. When names referring to two separate taxa of the same nomenclatural level are spelt the same, the two names are called **homonyms**. This situation arises when two separate authors used the same name to refer to two different taxa. This condition is called **homonymy**. In this situation the junior name is invalid and a new **replacement** has to be proposed.
5. A material on which an original description is based, gets a special status. It will form the basis for any future identity of a taxon. This idea is called the **type concept**. Thus the concept of a genus and species are fixed by their **type genus** or **type species**.
6. Names that were used prior to those included by Linnaeus in the “Systema Naturae”, tenth edition, 1758 are not recognised.
7. Scientific names must be either Latin or latinized. The name should be mentioned in italics.
8. The genus name should be a single word beginning with a capital letter.
9. The species name should be a single or compound word beginning with a small letter.

1.1.7 Identification keys

Identification of animals is an integral part of taxonomy. Identification could be made through literature, keys, pictures and comparison with type specimens. Of these, the most commonly used method is, using of keys.

A key is essentially a printed information or a computer software package. The construction of the key is an important job of a systematist.

A good key is strictly dichotomous and not having more than two alternatives at any point. The language of a key is telegraphic.

The key may be either **bracketed** or **indented**. In a **bracketed key** alternative contrastive characters are used for identification. The number on the right side indicates the next alternative character for consideration.

In an **indented key** a series of choices are provided for identifying a taxon. The user should choose from among the choices.

The following examples provide the keys for identification four species of frogs in Tamil Nadu, namely *Rana hexadactyla*, *R. tigrina*, *R. cyanophlictis* and *R. limnochoris*.

The Bracketed key (Genus : Rana)

- (1) Large size, snout - vent 100 - 200mm3
- (1) Small size, snout to vent less than 100 mm2
- (2) Pointed snout *R. limnochoris*
- (2) Obtusely pointed snout *R. hexadactyla*
- (3) 4th toe longer than others *R. tigrina*
- (3) 4th toe not longer *R. cyanophlictis*.

The Indented key (Genus : Rana)

Large sized body

skin smooth *R. hexadactyla*

skin with folds *R. tigrina*

Small size

blunt snout *R. cyanophlictis*

pointed or round snout *R. limnochoris*

1.2 Animal groups

1.2.1 Methods of grouping animals

There are several ways of grouping animals. In all these methods the basic Taxon remains without any change. However the taxa are rearranged in different groups. All these groupings are mostly provided for the convenience in identifying similar taxa.

I. One of the earliest method of grouping the animals could be dividing the Animal kingdom into two assemblages called **Invertebrata** and **Vertebrata**.

This scheme was provided initially by Aristotle. This scheme does not have a place for the Prochordates.

II. Animals can also be grouped as **single celled** and **multicellular**. The single celled organisms are called the **Protozoans**. The multicellular could be called the **Metazoans**. In this arrangement among the metazoans the unique nature of the sponges in not having a tissue grade of body constuction is not mentioned.

III. In yet another method the animals are grouped under following three assemblages.

1. **Protozoa** - single celled animals
2. **Parazoa** - Multicellular without tissue grade (sponges).
3. **Eumetazoa** - Multicellular with tissue grade.

Eumetazoa is a large group including most of the multicellular animals. Hence it is subdivided further into two groups.

1. Diploblastic animals - having ectoderm and endoderm as two layers in the body wall. Ex : Coelenterata.
2. Triploblastic animals - having ectoderm, mesoderm and endoderm as three layers in the body wall.

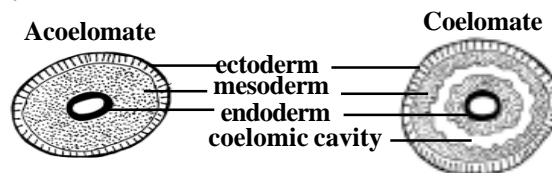

Fig. 1.2.1 Coelomic cavity

The **Triploblastic animals** are further divided into three groups based on the presence or absence of an embryonic body cavity called **coelom**.

1. Acoelomata - no coelom Ex : Platyhelminthes
2. Pseudocoelomata - with a false coelom Ex : Nematoda
3. Coelomata - with a true coelom

IV. In a recent system, the entire living world is subdivided into 5 kingdoms. This system is much more broader including algae, fungi, and plants. It is known as the **Five kingdom concept**.

1. **Kingdom : Monera** - It includes all bacteria and the cyanobacteria. A circular DNA occurs in the cytoplasm. The cell wall is a rigid structure.
a) Phylum : **Cyanobacteria** b) Phylum : **Bacteria**.

2. Kingdom : **Protocista** or **Protista** - It includes single celled eukaryotes. It has two subkingdoms, namely **Protozoa** and **Algae**.

3. Kingdom : **Fungi**

4. Kingdom : **Plantae** (green plants)

5. Kingdom : **Animalia** : multicellular, eukaryotic animals.

1.2.2 Major phyla

Phylum : Protozoa

This phylum includes a great diversity of small, microscopic organisms. These are **single celled** eukaryotes. Their locomotion happens using pseudopodia, cilia or flagella.

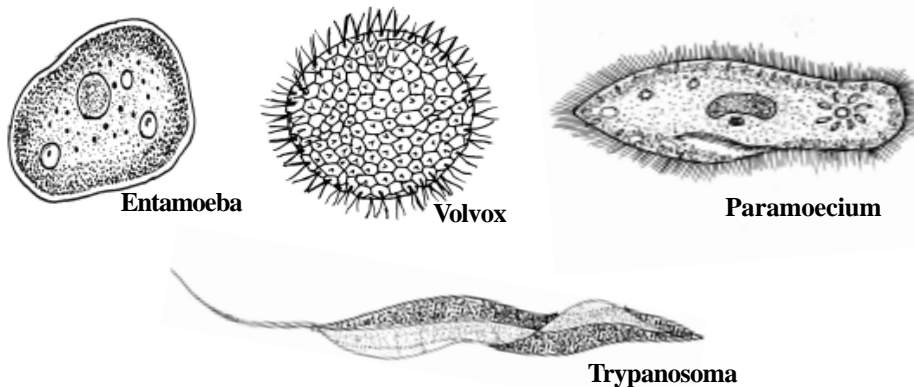

Fig. 1.2.2 Protozoans

The nutrition is either autotrophic or heterotrophic. They reproduce either asexually or by sexual methods. Ex : Amoeba, Paramecium, Plasmodium.

Phylum : Porifera.

These are multicellular, aquatic organisms. They have a **cellular grade** of construction without the occurrence of tissues. The sponges belonging to this phylum are characterised by the presence of a **canal system** in their body. The body wall contains spicules. They can reproduce both by asexual

and sexual methods. Ex : Sponges.

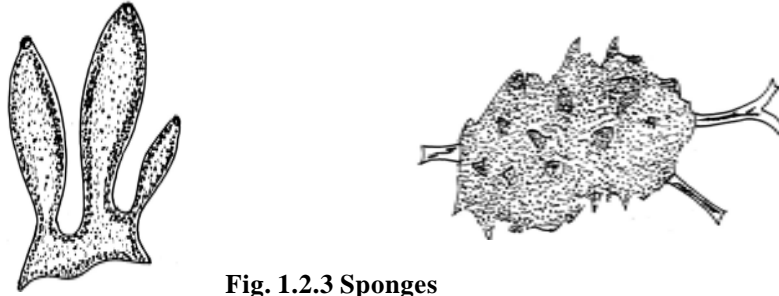

Fig. 1.2.3 Sponges

Phylum : Coelenterata or Cnidaria

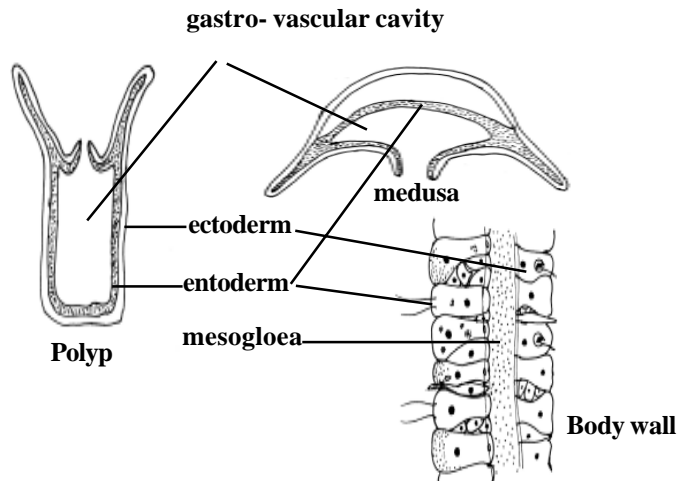

Fig. 1.2.4 Coelenterate-body wall

All coelenterates are aquatic animals. They are mostly marine. The body is radially symmetrical. The body wall is of two layers of cells. The outer layer is called the **ectoderm**. The inner layer, **entoderm** is separated from the ectoderm by a non-cellular **mesogloea**. The mesogloea is a jelly-like substance. Due to the presence of two layers in the body wall, these are said to be **diploblastic animals**.

Many coelenterates exhibit **polymorphism**. In this phylum, organisms exist in two different body forms namely, a **polyp**, and a **medusa**. The ectoderm contains stinging cells called **nematocysts (cnidoblasts)**. These cells when triggered can explosively penetrate prey and inject poison.

The layers in the body wall contain several cells and tissues such as muscle cells epithelial tissues, gland-cells and sensory cells.



Fig. 1.2.5 Nematocyst

They reproduce both asexually and sexually. They are divided into three classes, namely **Hydrozoa**, **Scyphozoa** and **Anthozoa**. In **Hydrozoa**, the animal has a dominant polyp body form and a reduced medusa stage. (e.g) *Hydra*, *Obelia*.

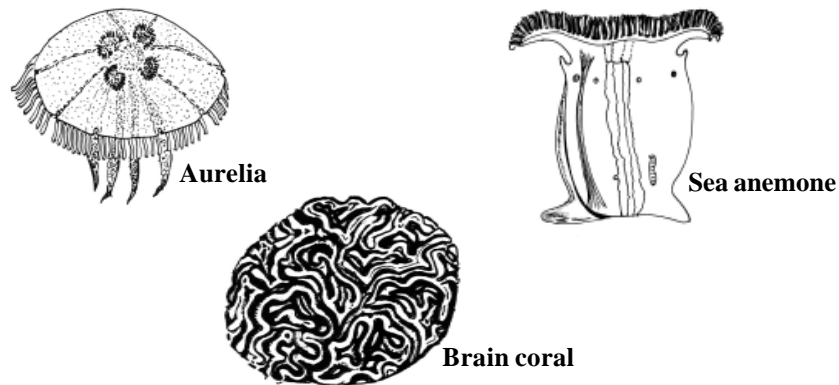

Fig. 1.2.6 Coelenterates

In Scyphozoa the medusa form is permanent. This group includes jelly fishes such as *Aurelia*. They swim in the surface waters. They have a bell shaped medusa stage.

The Anthozoans mostly remain as polyps. Their body cavity is divided by large radial partitions called **mesenteries**. (eg) **sea-anemone** and **corals**.

All animals of subsequent phyla show the following general characters.

1. All of them have three layers in the body wall. They are named as outer ectoderm, middle mesoderm, and inner endoderm. Thus they are called as **Triploblastic** animals.

2. The body is bilaterally symmetrical.

Phylum: Platyhelminthes :-

This phylum includes flatworms. These are acoelomates, without a body cavity called **coelom**. The alimentary canal is either absent or very simple. Excretion and osmoregulation occur through **flame cells**. These worms are mostly hermaphrodites, having both male and female reproductive organs in a single individual. Most of the members are parasites. It is divided into three classes, namely **Turbellaria**, **Trematoda** and **Cestoda**.

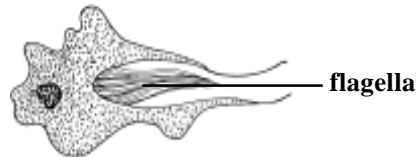

Fig. 1.2.7 A flame cell

Class Turbellaria :- These are free living aquatic flatworms. The Planaria of this class shows characteristic regeneration.

Class Trematoda :- These are flukes living as parasites inside a host (endoparasites). A protective **cuticle** covers the outer surface of the body. Flukes have **suckers** for attachment to the host tissues. The examples are **Fasciola** (liver fluke), **Schistosoma** (blood fluke).

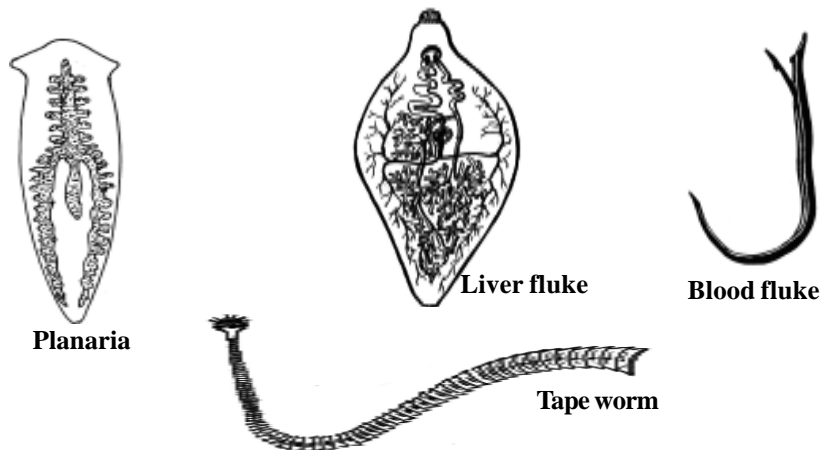

Fig. 1.2.8 Platyhelminth worms

Class Cestoda :- It includes all tape worms. These are internal parasites with a complex life history. The life cycle involves two hosts.

Their body characters are adaptations for parasitic life. Mouth and alimentary canal are absent. Food is absorbed through general body surface. The head is called the **scolex**. It has a ring of hooks and suckers for attachment to the host tissue. The body consists of several segments called **Proglottids**. (eg) sheep and cattle **tape worms**.

Phylum : Nematoda :-

These are the popular round worms. The body is narrow and pointed at both the ends. There are no body segments. The body is covered by a thin cuticle. The body cavity is considered as a pseudocoelom. The alimentary canal is a straight tube. They reproduce sexually and the sexes are separate. There are several free living soil nematodes. Others are parasites. (eg) *Ascaris lumbricoides*.



Fig. 1.2.9 *Ascaris*

In subsequent Phyla the animals show following general characters

- 1. There is a coelom within the mesoderm. Hence these are called as coelomates.*
- 2. The body consists of a series of compartments. This phenomenon is called as metameric segmentation. They have a circulatory system providing internal transport.*

Phylum: Annelida :-

These are worm like animals. The body segments are rings externally. Internally the segments are separated by **septa**. Externally the body is protected by a cuticle. Excretion and osmoregulation are achieved by ciliated tubules called **nephridia**. There is a central nervous system. The brain is

formed of **ganglia** in the head region. The nerve cord is ventral in position. For the first time head formation or **cephalization** happens. These are bisexual and hermaphroditic. The larva is called the **trochophore**.

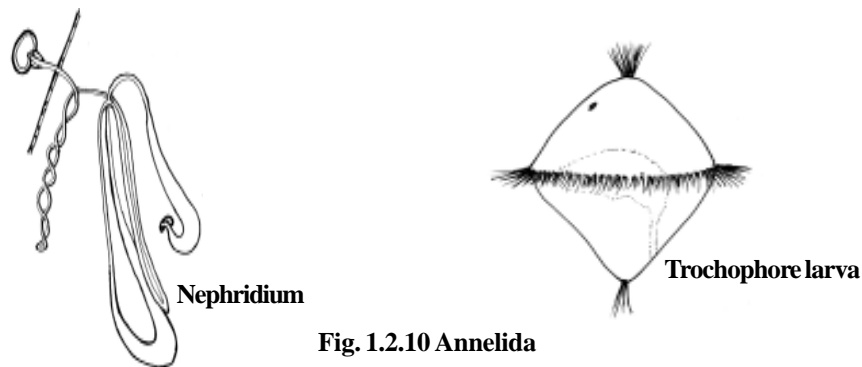

Fig. 1.2.10 Annelida

This phylum includes three Classes, namely **Polychaeta**, **Oligochaeta** and **Hirudinia**. The polychaetes are marine worms. They have a distinct head. There are pairs of lateral projections called **parapodia**. The examples are **Nereis** (ragworms), **Arenicola** (lugworm).

Earthworms are included in the Class Oligochaeta. The Class: Hirudinia includes **leeches**. These are blood suckers and ectoparasites. They have well developed suckers for attachment at anterior and posterior ends.

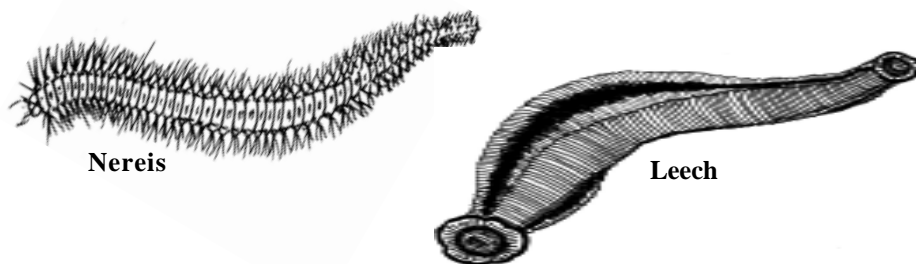

Fig. 1.2.11 Annelids

Phylum : Arthropoda :-

These are the most successful group of animals. They outnumber all other animals in population strength. The body is segmented. It is covered by a hard exoskeleton made of **chitin**. During growth the exoskeleton is shed (moulting of ecdysis). The legs or paired appendages are jointed. The head

region has a pair of prominent compound eyes. Each compound eye is made up of several photoreceptor sub units called Ommatidia.

They have an open circulatory system without vessels. The body cavity is filled with a fluid called **haemolymph**. Such body cavity is known as haemocoel. These are unisexual, exhibiting **sexual dimorphism**. The young forms produced are invariably called the **larvae**. The larvae undergo **metamorphosis** and develop into adults.

This Phylum comprises five Classes, **Class Onychophora**: It includes small worm like *Peripatus*. *Peripatus* shows Annelidan and Arthropoda characters. Hence this may be considered as a **connecting link** between the two groups.

Class Crustacea :- The examples for this class are **prawns, crabs** and **lobsters**. The dorsal body surface is covered by a sheild like **carapace**.



Fig.1.2.12 Myriapods

Class Myriapoda :- It includes **centipedes** and **millipedes**. These organisms have a distinct head and simple eyes. The centipedes have a pair of **poison claws**. The body consists of numerous segments, bearing pairs of legs.

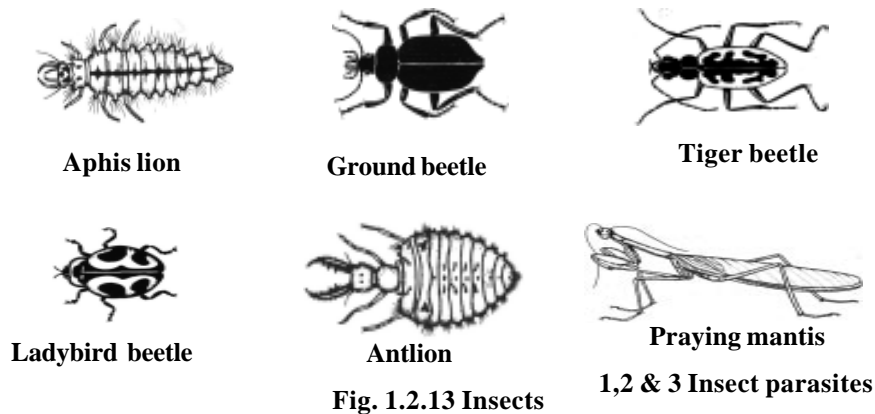

Fig. 1.2.13 Insects

Class Insecta :- It comprises the common insects. The body is divided into head thorax and abdomen. In several insects, the adults have two pairs of wings on the thorax. Respiration happens through the tracheal system.

Class Arachnida :- It includes **scorpions, spiders, ticks** and **mites**. The body is divided into **cephalothorax** and **abdomen**. There are four pairs of legs attached to the cephalothorax.



Tick



House spider

Fig. 1.2.14 Arachnids - Spiders

Phylum Mollusca :- It is a very successful and diverse group of animals. Considered to be the second largest group of animals with regard to species number. These are soft bodied animals without segmentation. The body is divided into **head, muscular foot** and **visceral mass**. The body is covered by a **mantle** and a **shell**.

Respiration happens through gills (ctinidia) in the mantle cavity. The most common larva is a **trochophore** larva.

There are seven classes of which three are more prominent.

Class Pelecypoda or **Bivalvia** :- These are aquatic molluscs having bivalves. They burrow in mud and sand. The body is laterally compressed. (eg) **mussels, clams, oysters**.

Class Gastropoda :- These are either aquatic or terrestrial molluscs. They possess a spiral shell.

The foot is large and flat. They have well developed head with tentacles and eyes. (eg) **snails, slugs, and limpets**.

Class Cephalopoda :- These are mostly marine. They are adapted for swimming. The foot is modified into eight to ten long tentacles in the head region. The shell is either internal or absent. (eg) **Octopus, Loligo, Sepia**.

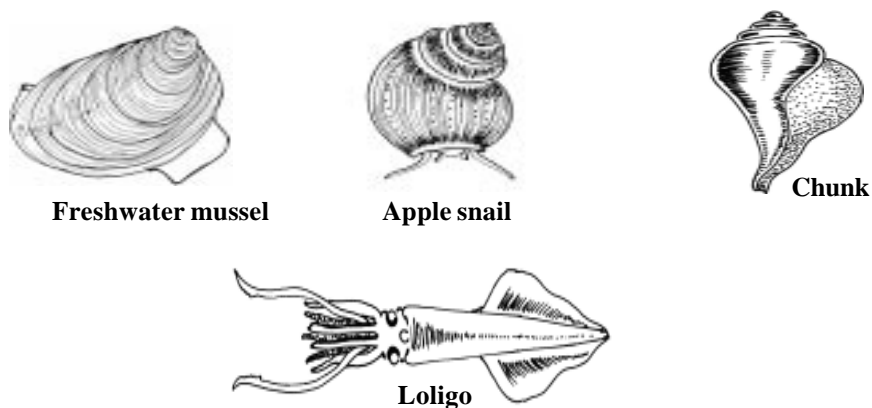

Fig. 1.2.15 Molluscs

Phylum Echinodermata :- These are marine organisms. While the adults are radially symmetrical the larvae remain bilaterally symmetrical. The mouth is on the lower surface. They have a **water vascular system** with **tube feet**. eg. **star fishes, brittle stars, sea urchins** and **sea-cucumbers**.



Fig. 1.2.16 Echinoderms

Phylum Chordata

This phylum derives its name from one of the common characteristics of this group namely the **notochord** (Gr. *noton*, back + L. *chorda*, cord). The animals belonging to all other phyla of the Animal Kingdom are often termed ‘the non -chordates’ or ‘the invertebrates’ since they have neither notochord nor backbone in their body.

The backboneed animals (vertebrates), together with a few closely related animals which do not possess a backbone, are included in this phylum. Most of the living chordates are familiar vertebrate animals. The chordates are of primary interest because human beings are members of this group.

Diversity of Chordates

The chordates exhibit an astonishing diversity in form, physiology and habits. The number of chordate species is limited. About 49,000 species are on record which are only half of the living species of molluscs and less than one tenth of arthropods. Despite their modest number of species, the chordates make remarkable contribution to the bio-mass of the earth. Nearly all of them are medium to large in size. The vertebrates in particular are considerably larger and many of them are among the largest of living animals. The gigantic **blue whale** which is 35 meters long and 120 tons in weight is the biggest known animal. The smallest vertebrate , **philippine goby** is a fish, measuring only 10 mm in length. The chordates are able to occupy various kinds of habitats. They have adapted themselves to more modes of existence than any other group. They are found in the sea, in freshwater, in the air and on all parts of land from the poles to the equator.

General Characters :

The three distinctive characteristics of the chordates are the presence of **notochord**, **dorsal tubular nerve cord** and **pharyngeal gill slits**.

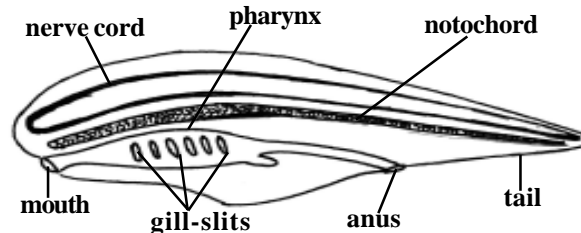

Fig. 1.2.17 Chordata - a diagrammatic structure.

1. Notochord :

During the embryonic development of a chordate there appears a supporting rod called the **notochord**. It lies dorsal to the alimentary canal and ventral to the nerve cord. In some chordates this structure persists throughout life. In others it is partially or completely replaced by a '**backbone**'. It is made up of separate **bony elements** or **vertebrae**. Structurally it is composed of large number of specialized **vacuolated** cells. It is surrounded by **fibrous** and **elastic sheath**. The stiffness of the notochord is due to the turgidity of fluid-filled cells and surrounding connective tissue sheath.

2. Dorsal tubular nerve cord

The nerve cord lies just above the notochord and remains entirely outside the coelom. It is a tubular structure having a small hollow canal running from one end to the other. The dorsal hollow nerve cord persists throughout the adult life of almost all chordates.

3. Gill slits or Pharyngeal clefts

These are paired lateral clefts leading from the pharynx to the exterior. They are present throughout life in fishes and a few tailed amphibians. In amphibians, like frogs and toads it is found only in the larval stages. In higher vertebrates (reptiles, birds and mammals) they are embryonic and non-functional.

4. Ventral heart

The heart is chambered. It is located ventral to the alimentary canal.

5. Closed blood vascular system

In chordates, the blood passes through a continuous system of tubes namely arteries, capillaries and veins.

6. Hepatic portal system

In chordates, the food laden blood from the digestive tract passes through the capillary net work in the liver, before reaching the heart. Thus the veins originating from the digestive tract as capillaries and ending in the liver again as capillaries constitute the hepatic portal system.

Classification.

The Phylum Chordata is classified into four sub phyla:

Sub phylum 1. Hemichordata,

Sub phylum 2. Cephalochordata

Sub phylum 3. Urochordata

Sub phylum 4. Vertebrata.

First three sub phyla are collectively known as **Protochordates**. Since the members of these sub phyla do not have a cranium or skull they are also referred to as **Acrania**.

Protochordata (Acrania)

The protochordates are considered as the fore runners of vertebrata. The classification of the protochordates is based on the nature of the notochord.

Sub phylum : Hemichordata.

These are exclusively marine organisms. They are solitary or colonial forms. They mostly remain as tubicolous forms. The body is soft, vermiform, unsegmented, bilaterally symmetrical and triploblastic. The body is divisible into three distinct regions namely proboscis, collar and trunk. The body wall is composed of single layer of epidermal cells. The dermis is absent. They have no endoskeleton. A projection from pharynx, projecting inside the proboscis **may be** considered as notochord. They have a spacious coelom lined by coelomic epithelium. The alimentary canal is a straight tube running between mouth and anus. They are ciliary feeders. Sexes are separate.

Examples : **Balanoglossus, Saccoglossus.**



Fig. 1.2.18 Balanoglossus

Sub phylum : Cephalochordata.

Cephalochordates are small fish like marine chordates. The persistent **notochord extends forward beyond the brain**. Hence these are called cephalochordates. The epidermis is single layered. Paired fins are absent. Muscles, nephridia and gonads are segmentally arranged. The pharynx is large with numerous gills. It is a filter feeder.

Example : **Amphioxus.**



Fig. 1.2.19 Amphioxus



Fig. 1.2.20 An ascidian

Sub phylum : Urochordata

This taxon constitutes a unique group of animals exhibiting diversity in form and habit. In Urochordata the **notochord is confined to the tail region** of the larva. The adults are mostly degenerate, sessile forms. The body is enveloped by a tunic or test. The free end of the body bears two openings, the mouth and the atriopore. The proximal part of the alimentary canal is greatly enlarged to form a spacious pharynx. They are hermaphroditic animals. The development occurs through free swimming tadpole like larva.

Example : **Ascidia, Doliolum, Salpa.**

Sub phylum : Vertebrata (Craniata)

This group is characterized by the presence of **brain case** or **cranium** and a **vertebral column** which forms the chief skeletal axis of the body.

The notochord is an embryonic structure. It is replaced in the adult stage by a **cartilaginous** or **bony vertebral column**. The body is covered with an **integument** having an outer **epidermis** and an inner **dermis**. The skin has many modifications such as glands, scales, feathers, claws horns and hairs.

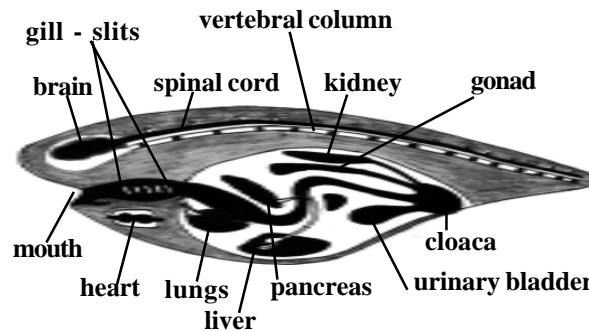

Fig. 1.2.21 A vertebrate- diagrammatic structure.

The digestive system is ventral to the vertebral column. It is provided with a large liver and pancreas. The circulatory system consists of the ventral, chambered heart. The circulatory system is of a closed type with arteries, veins and capillaries. The blood plasma contains red and white blood corpuscles. Gill slits are limited in number (usually 5 pairs). There are two pairs of appendages. The anterior part of the nerve cord becomes differentiated into brain and spinal cord. The special organs of sense like the nose, eyes and ears are closely connected with the brain. Urinary and genital systems are closely connected to form an urinogenital system.

The sub phylum vertebrata may be classified into two groups (i) **Pisces** and (ii). **Tetrapoda**.

Class : Pisces

Fishes are **poikilothermic**, aquatic vertebrates with jaws. The body is streamlined. It is differentiated into head, trunk and tail. Between head and trunk, the neck is absent. Locomotion is effected by **paired** and **median fins**.

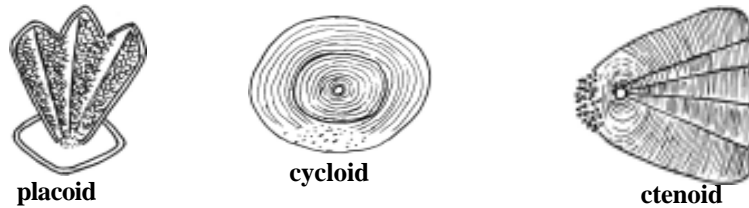

Fig. 1.2.22 Scales

The body has a covering of **scales**. They are of various types like **placoid**, **cycloid**, **ctenoid** and **ganoid** scales. The body muscles are arranged into segments called **myotomes**.

The Alimentary canal consists of a definite **stomach** and **pancreas** and terminates into **cloaca** or **anus**. Respiration is performed by **gills**. Gill slits are 5-7 pairs. They may be naked or covered by an **operculum**. The **heart** is two chambered (an auricle and a ventricle).

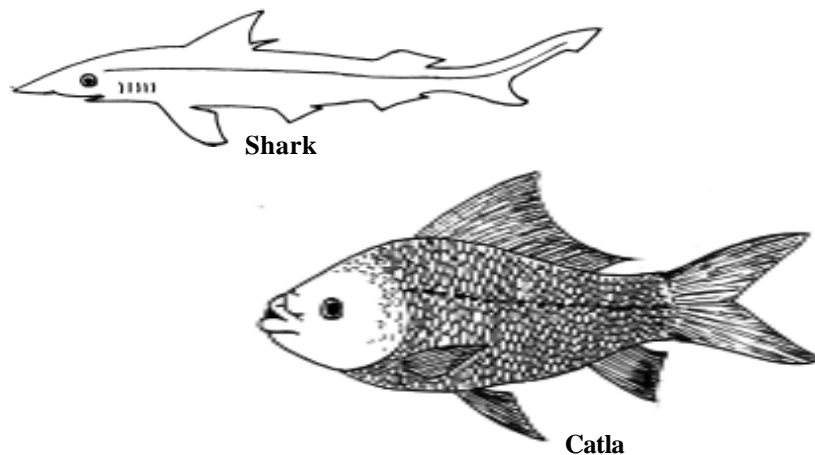

Fig. 1.2.23 Fishes

Sinus venosus and **renal portal** system are present. The red blood corpuscles are nucleated. The functional kidney of the adult is of **mesonephric** type. The **external nostrils** do not communicate with the buccal cavity. **Lateral line sense organs** are well developed. Sexes are separate. Fertilization is either internal or external. Examples: **Shark, Catla**.

Tetrapoda

The vertebrates with two pairs of limbs adapted for locomotion on land are known as **tetrapods**. The limbs are of pentadactyl type. The tetrapods are identified by a cornified outer layer of skin and nasal passages communicating with mouth cavity and lungs. The super class Tetrapoda is divided into four classes namely. **Amphibia, Reptilia, Aves** and **Mammalia**.

Class : Amphibia

The living representatives of this class include **frogs, toads, newts, salamanders** and limbless **caecilians**.

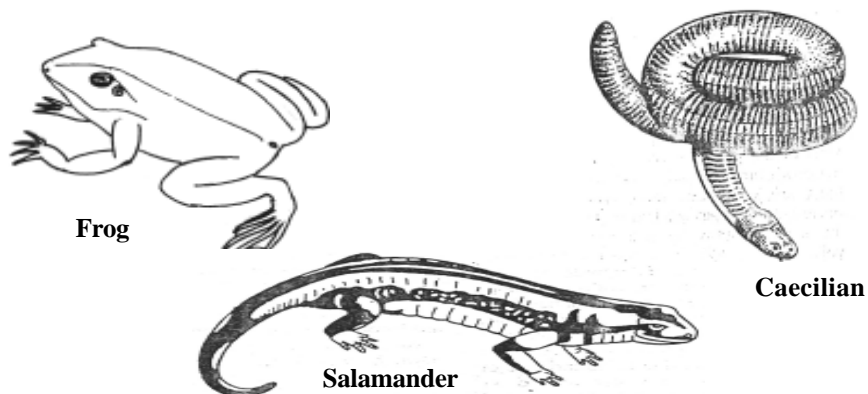

Fig. 1.2.24 Amphibians

The transition from aquatic to terrestrial living is clearly indicated in the class Amphibia. These were the first vertebrates to live on land. Amphibians are not completely land adapted. They hover between aquatic and land environments. This **double life** is expressed in their name, amphibia. It is because of, these reasons '**the amphibians are considered, a defeated group**'.

The body forms vary greatly from an elongated trunk with distinct head, neck and tail to a compact, depressed body with fused head and trunk and no intervening neck. The forelimbs of frogs and toads are smaller than hind limbs. In frogs, hindlimbs have webbed feet. The surface of the skin is

smooth and slimy. The slimy nature is due to the presence of mucous secreting glands. Scales are practically absent.

The mouth is usually large with small teeth in upper or both jaws. The external nostrils communicate into the anterior part of the mouth cavity. Respiration is effected by gills, lungs, skin and pharyngeal region. The heart is three chambered with two auricles and a single ventricle. The skeleton is mostly bony, with varying number of vertebrae; exoskeleton is absent. Sexes are separate. Fertilization is either external or internal. The tadpole Metamorphoses into adult.

Examples : Frog, Toad, Salamander, Caecilian

Amniota

The tetrapods like **reptiles**, **birds** and **mammals** are referred to as amniotes. The amniotes have certain membranes associated with embryos inside the egg. It is an adaptation in terrestrial forms during development. These membranes are the **amnion**, **chorion** and **allantois**.

Class : Reptilia

Reptiles are represented by lizards, snakes, turtles, tortoises, alligators, crocodiles and the tuatara lizard, *Sphenodon punctatum*.

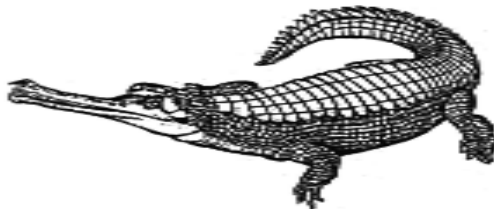

Gangetic crocodile



Leatherback turtle

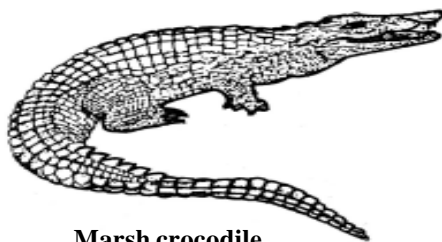

Marsh crocodile

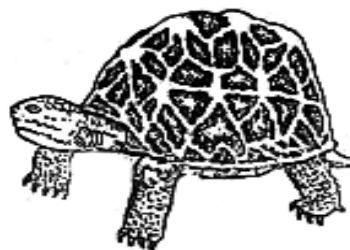

Star turtle

Fig. 1.2.25 Reptiles

The body is variable in shape. It is covered with an exoskeleton of horny imbricate epidermal scales. Skin glands are practically absent. The limbs are of pentadactyl type adapted for climbing, running and paddling. The endoskeleton is well ossified. Respiration is by lungs. The heart is three chambered (In crocodiles it is four chambered). The functional kidney of the adult are *metanephros*. The Sexes are separate. Fertilization is internal. The eggs are covered with leathery shells. Reptiles have developed some form of copulatory organ to transfer the sperms into the cloaca of the female.

Example : Garden lizard, Cobra, Monitor lizard, Crocodile, Turtle.

Class : Aves

Birds are one of the most interesting and widely known group of animals. There are more than 8600 species of birds distributed all over the world. Birds as a group exhibit a characteristic uniformity in structure.

Aves are **warm blooded** vertebrates with an exoskeleton of **feathers** forming a non-conducting covering to keep the body warm. The **feet** are covered with **scales**. The forelimbs are modified as **wings** and provided with feathers for flight. The hindlimbs are attached far forwards to balance the weight of the body. The bones are spongy, containing air-cavities rendering the body light. There is a fusion of bones and this is especially seen in the vertebral column. Only three digits are present in the forelimbs. In the hindlimbs there are four toes with the first directed backwards. A horny **beak** is present.

The alimentary canal ends in a **cloaca**. Inside the body **air sacs** are present and some of them communicate with air cavities in the bones. The heart is four chambered. The red blood corpuscles are oval and nucleated. The kidneys are three lobed. The ureters open into the cloaca. Urine is semi-solid and contains **uric acid**. The nervous system is well developed. Eyes are usually powerful and a specialized structure called **pecten** is present inside the eye ball to help in accommodation. Sexes are separate, Fertilization is internal. Eggs are provided with large amount of yolk. The egg is covered by a hard calcareous shell. In spite of several advanced features the birds have certain reptilian characters. Hence they are known as “**glorified reptiles**”.

Examples : Pigeon, parrot, crow, sparrow, peacock, ostrich, penguin.

Class : Mammalia

The term “mammalia” was given by Linnaeus (1758) to that group of animals which are nourished by milk from the breasts of the mother. They are a successful group, for they adapt themselves readily to new situations and to new food habits.

The body is generally covered with epidermal **hairs**. The integument is provided with **sweat, sebaceous** and **scent glands**. The **mammary glands** are modified integumentary glands. The external ear or the **pinna** is present in most of the mammals. A muscular **diaphragm** is present in between thoracic and abdominal cavities. It helps in respiration. The red blood corpuscles are non-nucleated, biconcave and usually circular in form. The heart is four chambered. Only the **left aortic arch** is present. In brain **cerebral hemispheres** are very large and highly convoluted.

Corpus callosum, a transverse band of nerve fibres connecting the two cerebral hemispheres, is present. Dentition is **thecodont, heterodont** and **di-phyodont**. Cloaca is absent. **Testes** lie outside the body cavity, enclosed in **scrotal sacs**. Eggs are small with little or no yolk. Fertilization is always internal. Mammals are **Viviparous** i.e., they give birth to alive young ones. **Placenta** is usually present.

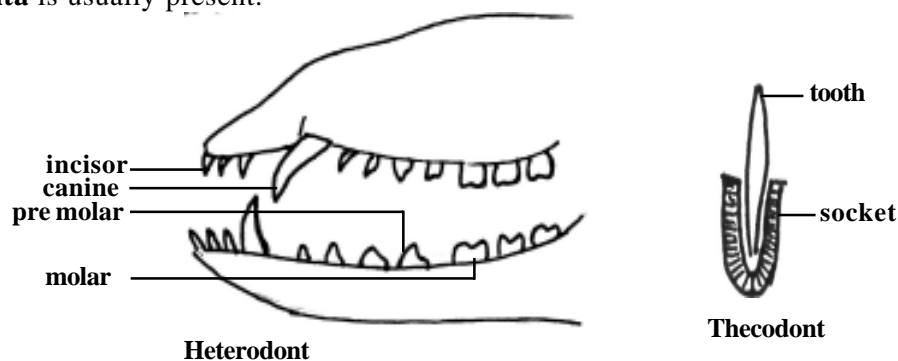

Fig. 1.2.26 Mammalian teeth

The class **Mammalia** is subdivided into three subclasses namely **Monotremata, Marsupialia** and **Placentalia**.

1. Sub class : **Monotremata** or **Prototheria**

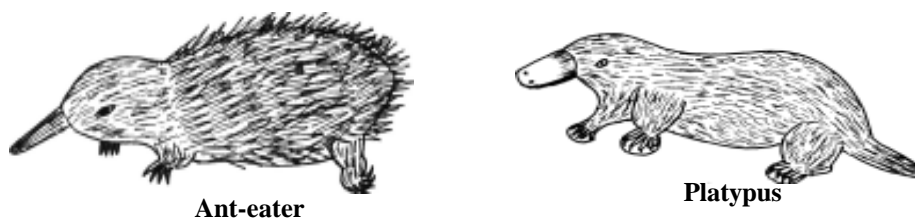

Fig. 1.2.27 Egg laying mammals

These are primitive **egg laying mammals** Example : Spiny ant-eater, duck billed platypus.

2. Sub class : Marsupialia or Metatheria

These are popularly called as **marsupials** or **pouched mammals**. The young ones are born in an immature stage and migrate into the pouch on the mother's body. Further development is completed in the pouch or **marsupium**.

Example : Kangaroo



Fig. 1.2.28 Pouched mammal

3. Sub class : Placentalia or Eutheria

In this group eggs develop within the uterus. The developing embryo receives nutrition through maternal blood circulation via the placenta.

Example : Elephant, tiger, lion, man, monkey, dog, cat , rat, bat.

Order Primates :

It is an order coming under the subclass Eutheria. This order is of interest because it includes **man**, besides **lemurs**, **tarsiers**, **monkeys** and **apes**. They inhabit chiefly the warmer parts of the world. This group stands first in the animal kingdom in brain development. However, most of them are unspecialized and **tree dwelling (arboreal)**. Primates are **omnivorous** in habit. The body is covered with **hairs** except palm, sole and parts of face. The **neck** is mobile. The forelimbs are shorter than the hindlimb. The limbs have five digits and all the digits end in flat **nail**. The **pollex** or **thumb** or **first toe** are smaller than other digits and are **opposable** (except the **hallux** of man). The brain is highly developed. The **cerebral hemispheres** are much

convoluted and cover the cerebellum. The **eyes are directed forward and the vision is binocular and stereoscopic**. **Mammae** are two and **thoracic** in position.

To know

Scientific Names

Peacock (மயில்)	<i>Pavo cristatus</i>
Crow (காகம்)	<i>Corvus splendens</i>
Sparrow (குருவி)	<i>Passer domesticus</i>
Rat (எலி)	<i>Rattus rattus</i>
Dog (நாய்)	<i>Canis familiaris</i>
Cat (பூனை)	<i>Felis domesticus</i>
Tiger (புலி)	<i>Panthera tigris</i>
Lion (சிங்கம்)	<i>Panthera leo</i>
Elephant (ஆசிய யானை)	<i>Elephas maximus</i>
Man (மனிதன்)	<i>Homo sapiens</i>
Monkey (குரங்கு)	<i>Macaca radiata</i>
Mongoose (கீரிப்பிள்ளை)	<i>Herpestes edwardsi</i>
Bear (கரடி)	<i>Ursus arctos</i>
Fruit bat (பழந்தின்னி வெளவால்)	<i>Cynopterus sphinx</i>
Donkey (கழுதை)	<i>Equus hemionus</i>
Rhinoceros (காண்டாமிருகம்)	<i>Rhinoceros unicornis</i>
Spotted deer (புள்ளி மான்)	<i>Axis axis</i>
Angel fish (ஏஞ்சல் மீன்)	<i>Pterophyllum scalare</i>
Guppy (கப்பி மீன்)	<i>Poecilia reticulata</i>
Apple snail (ஆப்பிள் நத்தை)	<i>Pila globosa</i>
House fly (ஈக்கள்)	<i>Musca nebula</i>
Bed bug (மூட்டைப் பூச்சி)	<i>Cimex hemipterus</i>
Cobra (நல்ல பாம்பு)	<i>Naja naja</i>
Parrot (கிளி)	<i>Psittacula krameri</i>
Garden lizard (ஓணான்)	<i>Calotes versicolor</i>

1.3. Type study - 1. Plasmodium

Phylum - Protozoa
Class - Sporozoa
Order - Haemosporidia

Members of the genus *Plasmodium* are collectively known as malarial parasites. They cause a febrile disease called **malaria**. Malaria as a chill and fever disease is known to mankind for a long time. Eradication of malaria is an important problem in public health. For a long time it was believed that malaria was caused by harmful vapours produced in marshy land (Gr. *Malo*-bad+air). **Charles Laveran**, a french military surgeon, for the first time, noticed *Plasmodium* in the blood of a malarial patient, in 1880. Its connection with the **intermediate host** and the modes of transmission were experimentally worked out in Calcutta by **Sir Ronald Ross** in 1889. For this discovery he was awarded the nobel prize for medicine in 1902. **Grassi** (1890) provided absolute scientific proof for the specific relationship between *Anopheles* mosquito and the human malarial parasite.

Plasmodium : The *plasmodium* is an intracellular sporozoan blood parasite. For the completion of life cycle it requires two hosts, a vertebrate and a blood sucking invertebrate. Transference of the parasite is effected by the invertebrate host. In man, the infection takes place by the inoculation of the slender, sickle shaped nucleated **sporozoite** in the blood by the bite of an infected female mosquito belonging to the genus *Anopheles*. At least four species of Plasmodium, *P. vivax*, *P. falciparum*, *P. malariae* and *P. ovale*, are known to attack man causing different kinds of malaria.

The life cycle of the malarial parasite involves two hosts, the man and the mosquito. The modes of development in these two hosts are different. In man the mode of reproduction is asexual and in mosquito it is sexual. Man is the **intermediate host** and the mosquito is the **definitive host**.

Life cycle in Man - Schizogony

There are two phases in the life cycle of malarial parasite in man. They are (1) **Pre erythrocytic cycle** or **Exoerythrocytic cycle** (in liver cells) and (2). **Erythrocytic cycle** or **Endo-erythrocytic cycle** (inside the red blood corpuscles)

Pre-erythrocytic cycle:

The pre-erythrocytic cycle comprises the asexual reproduction of the parasite in the liver. When an infected female *Anopheles* mosquito bites a person, thousands of slender, sickle shaped nucleated **sporozoites** are injected in the blood. The sporozoites first enter the capillary vessels of the skin and then enter the general circulation. These parasites circulate in the blood for about 30 minutes and enter into the pre-erythrocytic cycle in the **reticuloendothelial cells** of the liver.

Sporogony

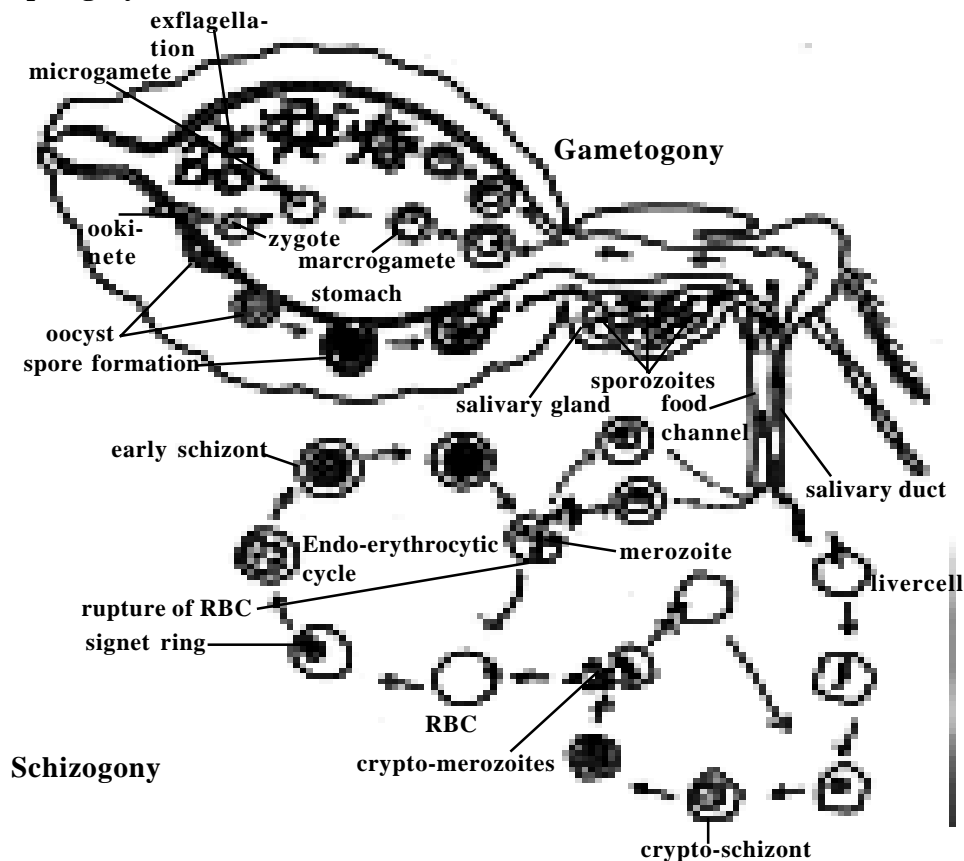

Fig. 1.3.1 Life cycle of malarial parasite

The sporozoites penetrate the liver cells and develop into forms known as **cryptozoites**. A cryptozoite has a compact nucleus and no pigment or

vacuoles. Cryptozoites rapidly grow feeding on the liver cells. When a cryptozoite has reached its full growth it fills the entire cell. In this stage it is known as the **crypto-schizont**. It undergoes **schizogony** and the resulting cells known as **crypto-merozoites** are set free in the blood by the rupture of the liver cells. The released crypto-merozoites invade fresh liver cells or red blood corpuscles. This cycle is considered as a period of incubation before the parasites could start the erythrocytic cycle. During this period of 7 - 17 days, the parasites are not seen in the blood stream.

Erythrocytic or Endo-erythrocytic cycle.

Each cryptomerozoite makes its way into a red blood corpuscle and feeds on its contents. After some time, the parasite gets an amoeboid shape. This growing stage is known as the **trophozoite** stage. Soon it develops a vacuole which gradually increases in size. Thus the nucleus is pushed to one side. This stage is called the **signet ring** stage. With further growth the vacuole disappears and the amoebula occupies the entire interior of the corpuscle. This stage is known as the **schizont** stage.

In the schizont, the nucleus breaks up into bits (6-24) and each becomes surrounded by a small amount of cytoplasm. These cells are known as **merozoites**. By the rupture of the wall of the red blood corpuscles the merozoites along with wastes (haemozoin) are released into the blood. This causes the malarial fever. The liberated merozoites attack another set of corpuscles and start the life cycle anew. This method of infection is known as **autoinfection**. The life cycle in the blood of man is called the **cycle of Golgi** or **schizogony** or **endoerythrocytic cycle**.

Schizogony keeps up the multiplication of the parasites and their maintenance in the blood.

After schizogony has taken place for several generations some of the merozoites which invade the red corpuscles, instead of developing into trophozoites and schizogonts, develop into **gametocytes**. The gametocytes are of two types - **macro-gametocytes** and **micro-gametocytes**. The macro-gametocyte has a small nucleus and a dense food laden cytoplasm. The micro-gametocyte has a relatively large nucleus and clear cytoplasm. Their further development depends on their entry into the stomach of a female **anophelis**. If it does not take place they disintegrate.

Life cycle in the mosquito - sporogony

When a female anopheles mosquito bites an infected person, it sucks blood along with all the stages of parasite. But in the gut of the mosquito, only the mature gametocytes survive and the rest of the stages are destroyed. From the gametocytes develop **gametes**. The process of development of gametes from gametocytes is known as **gametogony**.

Gametogony :

The nucleus of the micro-gametocyte divides into many fragments and the cytoplasm is thrown into flagellated structures. There may be as many cytoplasmic structures as there are nuclei. This process is known as **exflagellation**. The resultant cells are called the **microgametes**. The nucleus of the macro-gametocyte divides equally into two. The cytoplasm divides unequally. So among the resulting cells one is bigger and the other is smaller. The small cell is thrown out. This process is known as **maturation**. The resulting bigger cell is known as **female gamete** or **macrogamete**.

Syngamy and sporogony :

Inside the stomach of the mosquito the microgamete and the macrogametes come into union and nuclear fusion takes place. This kind of union is called **syngamy** and the resultant form is known as **zygote**.

The zygote assumes an elongated form and is capable of movement. It is known as **ookinete**. It pierces the wall of the stomach and comes to lie under the outer layer of stomach wall. There, it ceases to move, becomes round and forms a membranous cyst-wall. This stationary zygote enclosed in a cyst-wall is known as **oocyst**. It grows in size absorbing the nourishment from the host.

The nucleus of the oocyst divides repeatedly, each being surrounded by a fragment of cytoplasm. Thus inside the oocyst, a large number of cells develop into minute, slender, sickle shaped bodies called **sporozoites**. The cyst wall breaks, liberating the sporozoites into the **body cavity** (haemocoel) of the host. They wriggle forward and enter the salivary gland. When such an infected female **anopheles** mosquito bites a healthy person, it injects into his blood a stream of sporozoites. This kind of transmission is called **inoculation**.

Types of Malaria :

The disease caused by *Plasmodium* is known as **malarial fever**. It is characterised by recurring bouts of fever, each lasting several hours. The

febrile condition in man is due to toxins liberated into the blood along with the merozoites when the corpuscle is ruptured at the end of schizogony.

There are four species of *Plasmodium* known to cause malaria in man. The commonest and most widely distributed species is *P. vivax*. It causes **benign tertian malaria** in which the fever recurs every third day (every 48 hours). *P. falciparum* is largely limited to the tropics and subtropics and causes the **malignant tertian** or **subtertian malaria**. This type of malaria has a high death rate. Blood corpuscle parasitised by this species tend to clump together and block up small blood vessels and damage the essential organs. It is a dangerous species and the disease often appears in an epidemic scale. *P. malariae* causes **quartan malaria** with feverish fits every fourth day (every 72 hours). The fourth species is *P. ovale*. It is principally found in west Africa but occasionally in S. America, Russia and Palestine. It causes **benign tertian malaria** in which the fever recurs every third day (every 48 hours).

These four species differ from each other in the details of structure, time needed to complete the schizogony, the incubation period, number of merozoites released and duration of sexual cycle.

Control of Malaria

The control measures fall under the following three categories.

Treatment of infected patient

(1) Plasmodium does not produce antitoxins or antibodies in human blood. Therefore malaria cannot be treated by inoculation or vaccination with immune sera. It can only be treated with drugs that may kill all stages of the parasite without poisoning the patient. **Quinine**, which is extracted from the bark of **cinchona** trees, had been used effectively for the past 300 years to cure malaria. The various synthetic drugs, such as Paludrine, Atabrin, Camoquin, Chloroquine, Resochin, Pamaquin etc are used as suppressants of various stages of the parasites.

(2) Prevention of infection :

It can be effected in two ways.

(i) using protective measures such as mosquito nets, anti-mosquito creams (repellants) and coils.

(ii) use of the prophylactic drugs; small daily dose of anti-malarial drugs will kill the parasite either in the sporozoite or merozoite stage.

(3) Control of vector

It is perfectly clear that if the vector is completely exterminated the infection cannot be transmitted from one person to another. It is the most effective and surest way of controlling malaria. It is achieved by using effective insecticides and by draining swamps. It destroys the breeding places of mosquitoes.

Adult mosquito can be most effectively controlled by spraying DDT, malathion or any other insecticide in the houses; fumigating pyrethrum cresol and other compounds of naphtha; sterilization of male mosquitoes. The young stages of mosquito can be controlled by introducing larvivorous fishes like *Gambusia* and *Lebistes* in ponds, lakes, canals and tanks.

Type study - 2. Earthworm

Phylum	-	Annelida
Class	-	Chaetopoda
Order	-	Oligochaeta
Type	-	<i>Lampito mauritii</i>

Earthworms are nocturnal animals. They lie in the burrows during the day and come out at night for food. Earthworms leave the burrow only during the rainy season when their burrows are flooded with water.

External features

Lampito (*Megascolex*) *mauritii* is a common earthworm found in South India. The body is long, slender, cylindrical and bilaterally symmetrical. It is about 8 to 21 cm long and 3 to 4 mm in thickness. The dorsal surface is dark purplish brown, and the ventral surface is paler in colour. It is marked by a series of segments. The segments are separated from one another by inter-segmental grooves. The division is both external and internal. Inside the body, each cavity of the segment is separated from the next, by a thin partition called the **septum**. All the segments look alike. This kind of repetitive arrangement of the segments is called **metamerism**.

The **mouth** is found in the centre of the first segment of the body, called the **peristomium**. Overhanging the mouth is a small flap called the **upperlip** or **prostomium**. The last segment has the anus. It is called the **pygidium**. In mature worms, segments 14 to 17 may be found swollen with a glandular thickening of the skin called **clitellum**.

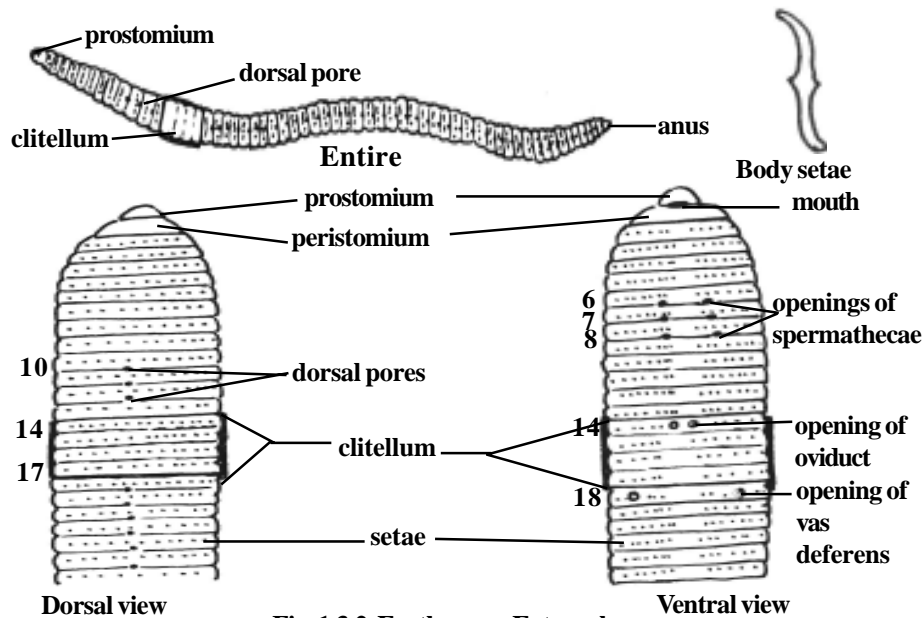

Fig. 1.3.2. Earthworm-External

Body setae

Tiny curved bristles called **setae** are found embedded in small pits of the body wall. These pits are called the **setigerous pits**. The setae are arranged around the body. They are made of chitin and have a swollen middle part and pointed curved ends. The setae resemble the mathematical symbol ‘ } ’. They can be moved in any direction and extended or withdrawn by the action of muscles. They are used for locomotion.

External apertures :

(i). **Dorsal pores** : These are minute openings situated in the mid dorsal line in the intersegmental grooves commencing from the 10th segment. The coelom communicates to the exterior through these pores and keep the body surface moist and free from harmful micro organisms.

(ii). **Spermathecal openings** : Three pairs of openings are situated ventrolaterally in the intersegmental grooves between segments six and seven, seven and eight and eight and nine. These opening can be easily seen in mature worms.

(iii). **Openings of oviduct** : These are a pair of apertures lying close together on the ventral surface of the 14th segment.

(iv). **Openings of Spermiduct** : A pair of apertures are situated on the lowerside of the 18th segment.

(v). **Nephridiopores** : Numerous minute openings scattered on the body wall from 14th segment onwards.

Body wall :

The body wall of earthworm is thin soft and moist. It consists of the following layers arranged from outside.

Cuticle : It is a thin, transparent, iridescent layer secreted by the underlying epidermis.

Epidermis : It is in the form of a single layer of columnar cells. This layer contains gland cells and receptor cells.

Dermis : It is a very thin sheet of connective tissue forming a basement for the epithelial cells on the outside and muscles on the inside.

Muscles : The muscles are arranged in two layers, namely the outer circular and inner longitudinal.

Coelomic epithelium : It is the inner most layer of the body wall forming the lining of the body cavity.

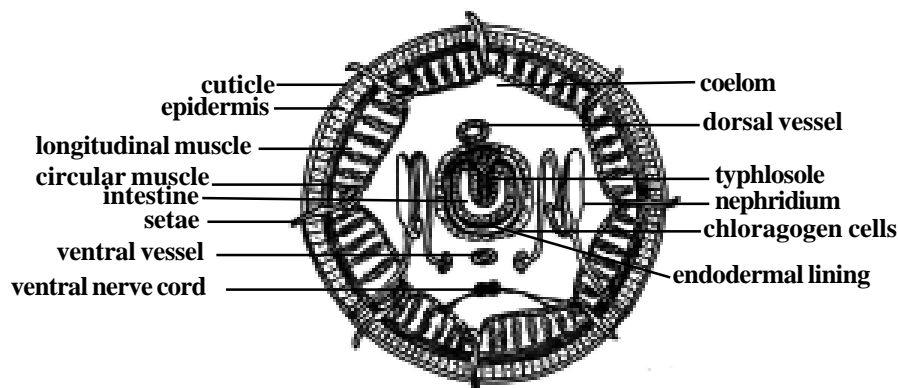

Fig. 1.3.3. Earthworm-T.S.

Body Cavity :

A spacious body cavity called the coelom is seen between the alimentary canal and the body wall. It is divided into a series of compartments by the transverse partitions of connective tissue called the septa. The coelom is lined with the coelomic epithelium and filled with coelomic fluid. It is a colourless fluid with amoeboid coelomic corpuscles floating in it. The fluid oozes out through the dorsal pores. It keeps body surface moist as a condition quite

essential for respiration. The coelomic cavity communicates to the exterior through reproductive and excretory apertures. The germ cells are budded off from the wall of this cavity.

Locomotion :

Earthworms move about by contraction and expansion of its body wall. When the circular muscles of the body wall contract, the body becomes thin and elongated. This process results in the forward extension of the body. Then it fixes itself firmly to the ground with help of the body setae and mouth. Subsequently when the longitudinal muscles contract, the body becomes thick and shortened. As a result, the body is drawn forward towards the anterior end which is already fixed to the ground. Thus by a repeated process of alternate contraction and expansion of muscular body wall locomotion is effected.

Digestive System :

The digestive system runs as a straight tube from mouth to anus. The **mouth** is situated in the first segment. The mouth opens into the **buccal cavity** which occupies segments 1 and 2. The buccal cavity in turn leads into a thick muscular **Pharynx**. The pharynx occupies segments 3 and 4 and is surrounded by the **pharyngeal glands**. The oesophagus is a short narrow tube lying in 5th segment. It leads into the **gizzard** lying in the 6th segment. Its inner surface has a chitinous lining. The intestine is a large tube extending from the gizzard to the anus. The intestine upto the 14th segment is narrow and the remaining part is sacculated. The dorsal wall of the intestine is folded into the cavity as the **typhlosole**. This fold contains blood vessels. It increases the absorptive area of the intestine. The inner epithelium consists of columnar cells and glandular cells.

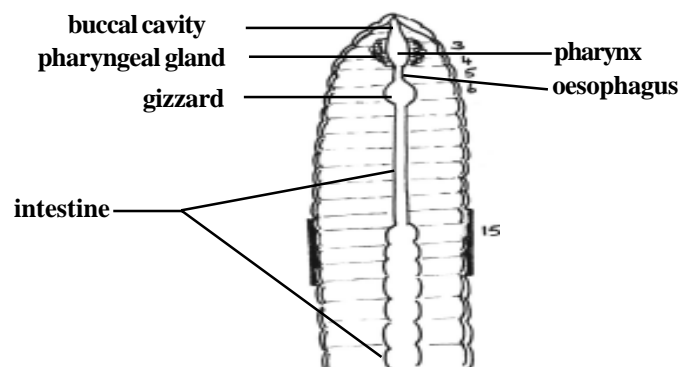

Fig. 1.3.4. Earthworm-Digestive system

Feeding :

The earthworm feeds on decaying organic materials contained in the soil. It takes the soil into its alimentary canal where the organic matter is digested and absorbed. The unwanted soil particles are sent out as **worm casts**.

Circulatory System :

In the body of earthworm there are two median longitudinal vessels. The **dorsal longitudinal vessel** runs above the alimentary canal. The **ventral longitudinal vessel** runs below the alimentary canal. The dorsal vessel is contractile and blood flows forwards in it. There are paired valves inside this vessel which prevent the backward flow of the blood. The ventral vessel is non contractile and blood flows backwards in it. The ventral vessel has no valves. In the anterior part of the body the dorsal vessel is connected with the ventral vessel by eight pairs of **commissural vessels** or the **lateral hearts** lying in the segments 6 to 13. These vessels run on either side of the alimentary canal and pump blood from the dorsal vessel to the ventral vessel.

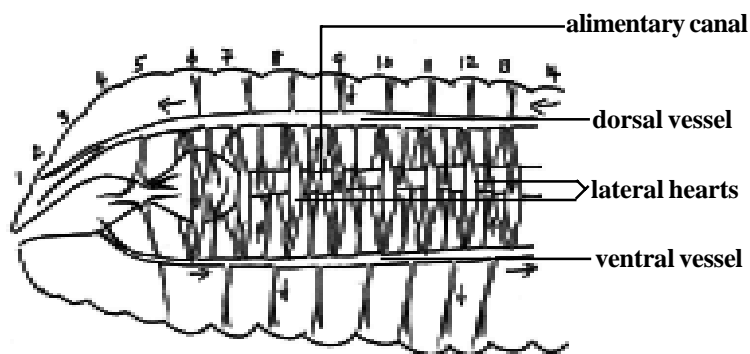

Fig. 1.3.5. Earthworm - Circulatory system-Lateral view

The dorsal vessel receives blood from various organs in the body. The ventral vessel supplies blood to the various organs.

Excretory System :

Excretion is the process of elimination of metabolic waste products from the body. In earthworm, excretion is effected by minute paired tubes called **nephridia**. These are found, one pair, in each segment.

A typical **nephridium** has an internal funnel like opening called the **nephrostome**. It is fully ciliated. The nephrostome is in one segment and the rest of the tube will be in the succeeding segment. This tube has three distinct

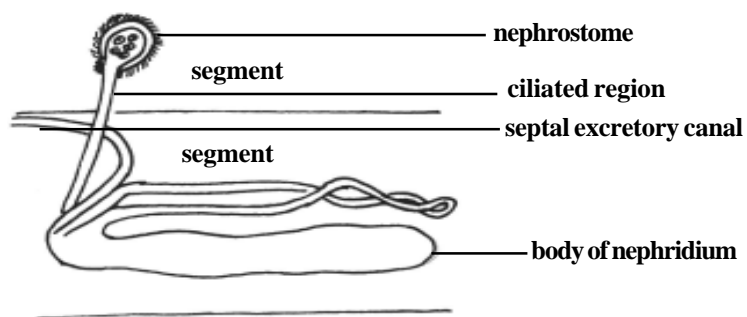

Fig. 1.3.6. Earthworm - nephridium

divisions. The first part following the nephrostome is ciliated inside. This is called the **ciliated region**. The next part is wider and is thrown into coils. This part has glands on its wall. It is called the **glandular region**. The last part has neither cilia nor glands. It is called the **muscular region**. This region opens outside by an aperture called the **nephridiopore**. The waste material is collected from the body cavity by the ciliated funnel. The ciliated region pushes the waste into the nephridium. The glandular part extracts waste from the blood and add it on to the waste inside. Finally the waste goes out through the nephridiopore.

In the South Indian earthworm, *Megascolex*, there are certain modifications. There are three types of nephridia in the megascolex. They are : (i). **Meganephridia**, (ii). **micronephridia**, (iii). **Pharyngeal nephridia**.

Besides nephridia there are some special cells on the wall of the intestine called **Chlorogogen cells**. They collect the waste and then drop down into the body cavity. These are then sent out through nephridia.

Nervous System :

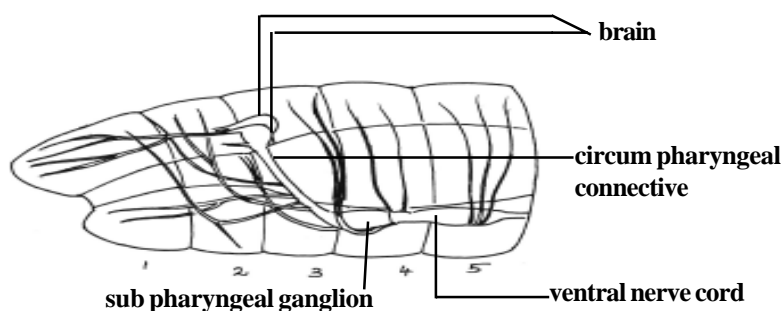

Fig. 1.3.7. Earthworm - Nervous system

The **brain** is formed of the **supra pharyngeal ganglia**. It is a bilobed mass of nervous tissue situated on the dorsal wall of the pharynx in 3rd segment. The ganglia found below the pharynx in the 4th segments is called the **subpharyngeal ganglia**. The brain and the subpharyngeal ganglia are connected by a pair of **circum pharyngeal connectives**. They run one on each side of the pharynx. Thus a nerve ring is formed around the anterior region of the alimentary canal. The double, solid ventral nerve cord runs backwards from the subpharyngeal ganglia, in the mid ventral line to the hind end of the body. The ventral nerve cord has segmental ganglion one in each segment. From the brain nerves are given off to the peristomium. From each ganglion of the ventral nerve cord, three pairs of nerves are given off to the body wall and other organs.

Receptors which are stimulated by the sense of touch (**tactile receptors**), Chemical changes (**chemoreceptors**) and changes in temperature (**thermoreceptors**) are present in the body wall. These receptors are in the form of groups of slender columnar cells with short hairs projecting at the free end and connected with sensory fibres at the inner end. Receptors stimulated by changes in the intensity of light (**Photoreceptors**) are found on the dorsal surface of the body. **Gustatory receptors** (sense of taste) and **olfactory receptors** (sense of smell) are found in the buccal cavity.

Reproductive System :

Both male and female reproductive organs are present in the same worm. Hence the earthworms are known as **hermaphrodites**. Since the sperms develop earlier than production of ova, self-fertilization is avoided. It is known as **protandry**.

Male reproductive organs :

The male sex organs are formed of two pairs of **testes** and a pair of **vasa deferentia**. Testes are found in segments 10 and 11. They are tufts of finger shaped processes attached to the anterior septa of segments 10 and 11. There are two pairs of seminal vesicles formed as outgrowths of the testicular segments. Further two pairs of **seminal funnels** called **ciliary rosettes** are situated in the same segment as the testes. The ciliated funnels of the same side are connected to a long tube called **vas deferens**. The two vasa deferentia of both sides run backwards along the ventral body wall upto the 18th segment where they open to the exterior through the male genital aperture. Male genital apertures contain **penial setae** for copulation. A pair of **prostate glands**, each in the form of a much coiled tube are situated in segments 18 and 19. The prostate glands open to the exterior along with the vas

deferens. The secretion of the prostate glands help to arrange the sperms into bundles called **spermatophores**.

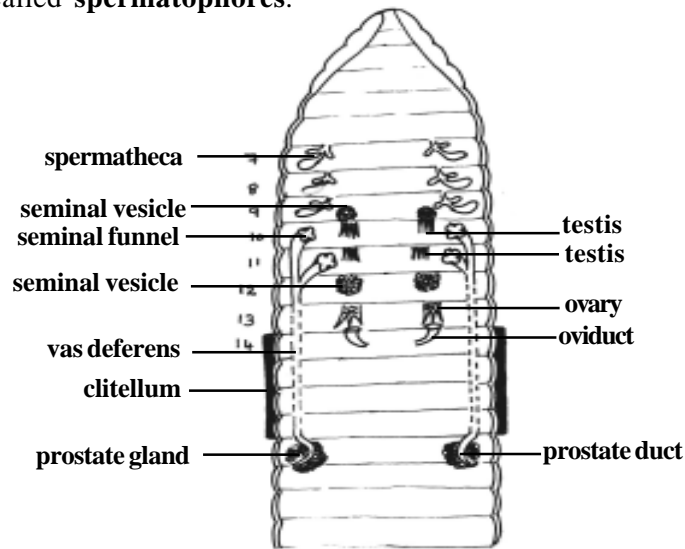

Fig. 1.3.8. Earthworm - Reproductive system

Female reproductive organs.

A pair of **ovaries** are found lying in segment 13. They are attached to the anterior septum of the 13th segment. Each ovary is a flat structure with a number of finger like processes. The ova are arranged in a linear order in the ovaries. There are a pair of **oviducts**. They open internally into the 13th segment and externally on the ventral surface of the 14th segment. Three pairs of **spermathecae** are present in segments 7, 8 and 9. These external openings are situated in the intersegmental grooves of segments 6 and 7, 7 and 8, and 8 and 9. The spermatozoa received from another individual during copulation are stored in **spermathecae**.

Copulation :

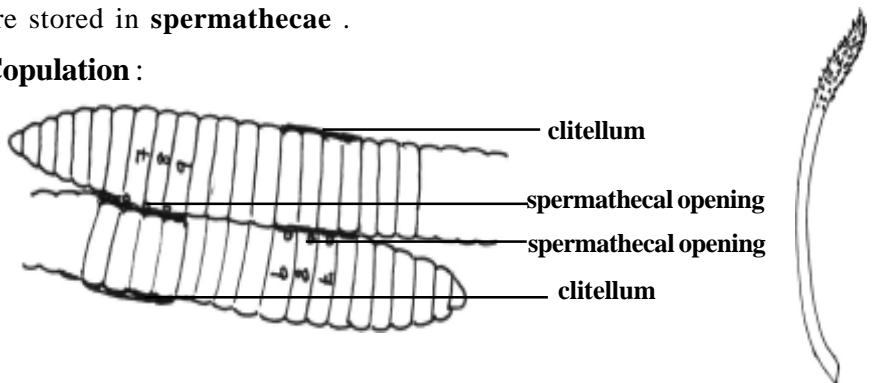

Fig. 1.3.9. Earthworm - copulation

Penial setae

During copulation the head ends of the two worms are directed in the opposite directions and the clitellum of one worm is opposite to the spermathecal segments of the other. The spermatozoa of one worm pass into the spermathecae of the other worms. The worms separate after the mutual exchange of spermatozoa.

Later the glandular cells of the clitellum secrete a thick fluid which hardens into a **girdle** surrounding the clitellum.

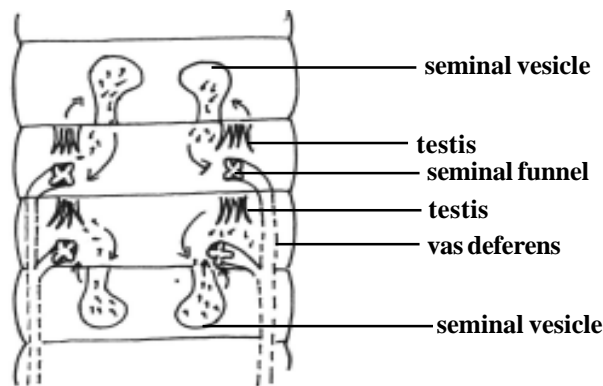

Fig. 1.3.10. Earthworm - Sperm transfer, storage and fertilization

The girdle is moved forward by the wriggling movements of the body. As the girdle is moved forwards it receives the ova and spermatozoa. The girdle containing the germ cells (ova and sperms) and the nutrient albuminous fluid is slipped off at the anterior end and it becomes a closed sac called the **cocoon**. Fertilization and the development of the eggs into worms takes place within the cocoon. Young worms come out of the cocoon after complete development.

Type study - 3. Pigeon

- | | |
|-------------------|-------------------------------|
| Sub phylum | - Vertebrata |
| Class | - Aves |
| Order | - Columbiformes |
| Type | - <i>Columba livia</i> |

Birds are easily recognised group of vertebrates. In birds every part of the body is modified to suit their aerial mode of life. Birds possess feathers, beak and feet modified in relation to their aerial life.

The Pigeons are flying birds(carinate). They are known both as wild and domesticated forms. The Pigeons are seen both in tropical and temperate

zones. About 10 species of Pigeons are found in India. The pigeons fly in flocks and roost together. The domestic pigeons have many varieties, namely panter, fantail and tumblers. They differ in size, colouration and feather arrangement. All of them are, however, descendants of the rock pigeon-*columba livia*.

External features.

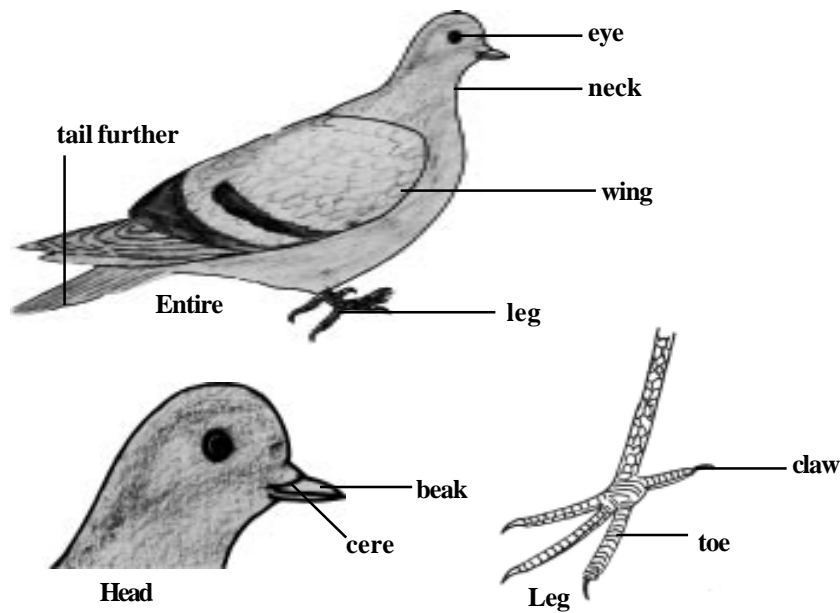

Fig. 1.3.11. Pigeon - External

The Body is spindle shaped. Their size varies from 20-25 cm. They are covered by coloured feathers leaving beak and a small portion of the hindlimbs.

The body is divisible into **head, neck, trunk** and a small, conical **tail**. The head is round and drawn out anteriorly into a strong, hard, pointed **beak**. The mouth is a terminal wide gape, guarded by elongated upper and lower beaks. The beaks are covered with a horny sheath or **rhamphotheca**. A swollen area of soft skin, the **cere**, surrounds the **nostril**. It is present on each side of the upper beak. The **eyes** are large and guarded by upper and lower **eyelids** and a transparent **nictitating membrane**. A pair of **ear openings** are situated at a short distance behind the eyes. Each opening leads into a short **external auditory meatus**, ending in the **tympanic membrane** forming the ear drum.

The neck is long and mobile. It helps in the movement of the head in various directions. The trunk is compact, heavy and bears a pair of **wings** and a pair of **legs**. The **cloacal aperture** is at its hind end on the lower surface. Projecting behind the cloacal aperture is the tail. Above the tail is a knob on which opens an **oil gland** or **preen gland** or **uropygeal gland**. It secretes a fluid used for preening the feathers.

The wings :-

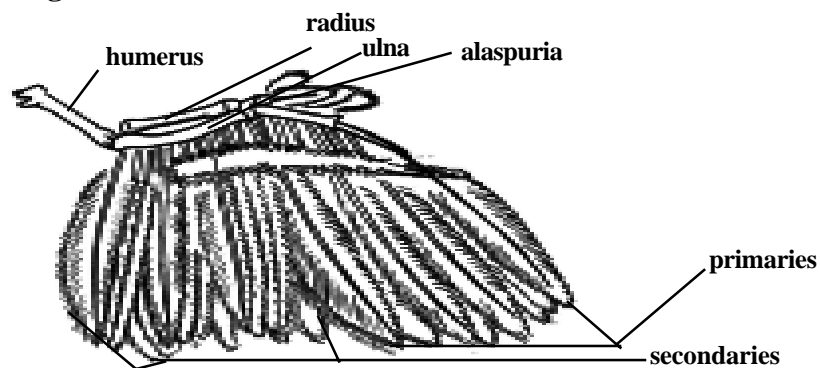

Fig. 1.3.12. Pigeon - a wing showing feather arrangement

The forelimbs as modified wings are located in the anterior region of the trunk. The limbs are of the pentadactyl type. The wing has three typical divisions as - the **upper arm**, **forearm** and **hand**. The hand has three imperfectly marked **digits**. While the pigeon is at rest the three divisions of the wing are bent upon one another in the form of the letter 'Z'. During flight the wings are straightened and extended. A fold of skin the **alar membrane** or **prepatagium**, stretches between the upper and forearm along the anterior border of the limb. A smaller fold known as **postpatagium** is present between the trunk and upperarm.

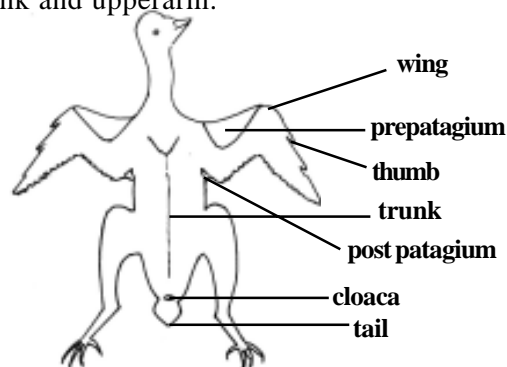

Fig. 1.3.13. Pigeon(feathers removed)

While the pigeon is not flying the whole weight of the body has to be supported by the hind limbs, In order to balance the heavy trunk the hindlimbs are attached for forwards. Each hindlimb or leg has three typical divisions, the **thigh, shank** and **foot**. The thigh without being free is enclosed within the boundaries of the trunk. Each hindlimb has four digits. The first toe is directed backward. The feet are naked and covered with horny **epidermal scales**. Each digit is provided with a horny **claw**. The tail is small and concealed by the feathers of the trunk. It bears the **tail feathers** or **rectrices**.

Exoskeleton :-

The feathers are integumentary structures. They are characteristic of birds. The feathers are derived from the epidermis. They are seasonally or periodically cast off and the new one being developed from the old papillae. They are arranged on the skin in definite tracts, called **feather tracts** or **pterylae**. The interspaces without feathers are known as **apteria** or **featherless tracts**.

There are three types of feathers in pigeon. They are the large **quill feathers** found on wings and tail for flight, the **contour feathers**, forming a covering for the body and the **filoplumes**, lying between the contour feathers.

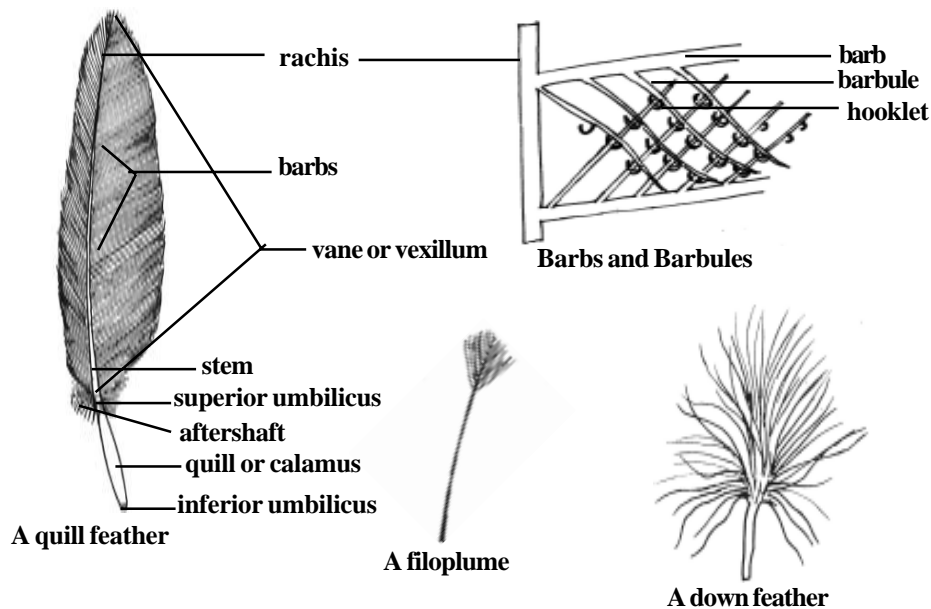

Fig. 1.3.14. Pigeon - Feather types

Quill feather :

Each quill feather has a central **stem** or **scapus**. It is divided into lower hollow part called the **quill** or **calamus** and a solid upper part termed **rachis**. The quill has at its lower end an opening called **inferior umbilicus**, through which vascular processes or papilla of the dermis project into the growing feather. Another opening the **Superior umbilicus** occurs at the junction of quill and the rachis on the inner face of feather. Close to this opening, there is a small tuft of soft feathers called **aftershaft**. Attached to the rachis are small **filaments** or **barbs**. The rachis with the barbs constitute the **vane** or **vexillum**. Each barb is provided with **barbules** and **hooklets**. The barbs remain attached with one another to form a continuous blade for striking the air in flight.

There are twenty three quill feathers or **remiges** in each wing. Eleven of these known as **primaries**, are attached to the hand. The remaining twelve fixed on the forearm are called **secondaries**. Attached to the thumb is a small tuft of feathers known as **ala spuria** or **bastard wing**. The tail bears twelve **tail feathers** or **rectrices** which are arranged in the form of a fan.

The **contour feathers** are soft and the barbs are plume like with no interlocking mechanisms. These help to keep the body warm and lock air pockets. The **filoplumes** have delictae hair like long axis and a few barbs devoid of barbules. **Down feathers** have small axis and a few barbs devoid of locking structures at the distal end. Nestlings are covered with down feathers.

Endoskeleton :-

The endoskeleton of pigeon is strong but lightly built. The texture of the bone is often spongy. Bone marrow is absent. The air spaces from the lungs may continue into the bones, making them light. The bones are more or less devoid of bone marrow. These are called **Pneumatic bones**. Most of the bones except those of the tail, forearm, hand and hind limb contain air spaces. In general there is a tendency for the reduction and fusion of bones. It gives rigidity to the skeleton.

Flight muscles :-

The wings are the modified forelimbs. They are organs of flight. The musculature of the forelimbs are greatly modified in response to the function they perform. Flight is the coordinated effort of a number of paired muscles of which the following are most important.

Pectoralis major (Depressor muscles)

These are the largest breast muscles. They are about one fifth of the body weight. By the contraction of this muscle the wings are lowered during flight.

Pectoralis minor or subclavius :-

These are smaller but longer than pectoralis major. By their contraction the wings are raised in flight.

Coracobrachialis :-

These small flight muscles pull the wing downwards in flight.

Digestive system :-

The two jaws of the mouth are modified into **beak**. Both the jaws are devoid of teeth. The mouth leads into the **buccal cavity**. The floor of the buccal cavity is provided with a narrow, triangular **tongue**. It has a horny covering and is provided with sensory papillae. The buccal cavity narrows behind into the **Pharynx**. The salivary glands are absent in the buccal cavity. Three pairs of **buccal glands** are present in the mouth. Their secretion is mainly mucous.

The alimentary canal proper starts from the **Pharynx**. The Pharynx leads into a long **oesophagus** that runs back through the neck. At the base of the neck region, it enlarges into a thin walled, distensible sac known as **crop** containing mucous glands. It serves as a store house for the food. The crop is followed by the **stomach**. The stomach is divisible into two parts, the anterior tubular **proventriculus** containing **gastric glands** and a posterior laterally compressed **gizzard**. The gizzard has a thick muscular wall and a horny inner lining. Its cavity is small and contains small stones which are helpful to grind the food. Thus the gizzard acts as a **grinding mill**. This type of arrangement is necessary because of the absence of teeth in the buccal cavity. The intestine arises from the right side of the gizzard. It is divisible into an anterior U- shaped **duodenum**, and a posterior long coiled **ileum**. The ileum enlarges posteriorly into a short **rectum** or large intestine. Anteriorly, the rectum bears a pair of small rectal caeca. The rectum opens to the exterior by the cloaca.

Internally the **cloaca** is divided into three chambers, the anterior **coprodaeum**, the middle **urodaeum** and the posterior **proctodaem**. The rectum opens into the coprodaeum. The urinogenital ducts open into the urodaeum. The proctodaem opens to the exterior by a transverse slit like

aperture called cloaca. At the proctodaeum, there is a dorsal glandular sac known as **Bursa of Fabricii**. Its function is unknown.

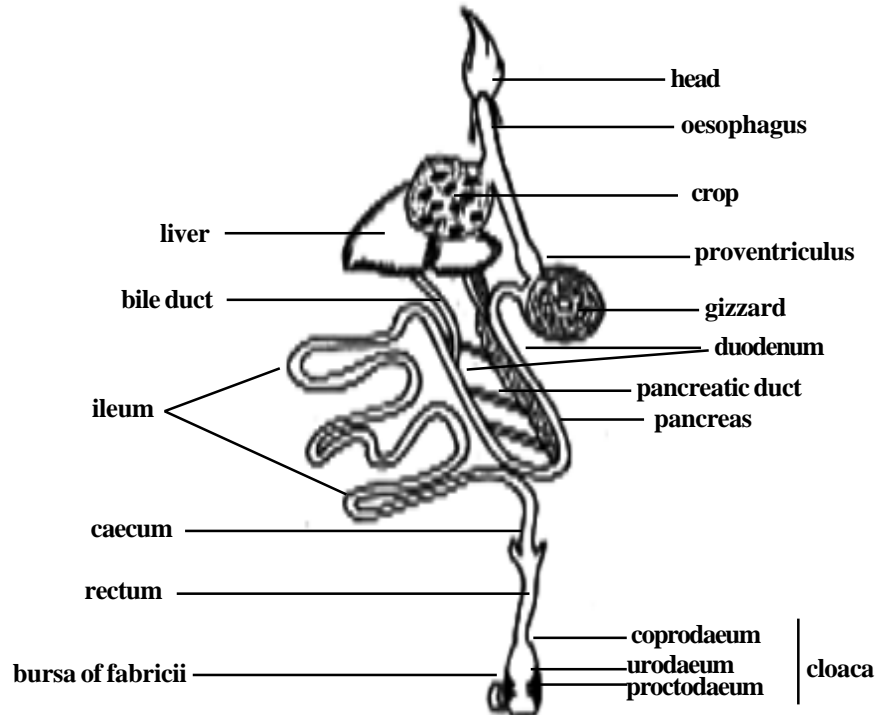

Fig. 1.3.15. Pigeon Digestive system

The digestive glands associated with the alimentary canal are the **liver** and the **pancreas**. The liver is bilobed with a large right and a small left lobe. It is devoid of gall bladder. There are two **bile ducts**. They are formed one from each lobe. They open into the duodenum independently. The pancreas lies between the two limbs of the duodenum. It has three ducts, all opening into the distal limb of the duodenum.

Respiratory System :-

The flight activity requires a continuous and abundant supply of oxygen. Hence, the respiratory system of pigeon is highly developed and well differentiated. The respiratory system consists of external nostrils, glottis, larynx, trachea, bronchus and lungs.

The **external nostrils** are a pair of slit like apertures occurring at the base of upper beak. They communicate to the **pharynx** by internal nostrils. A **glottis** lies behind the tongue. It opens into the **larynx**. The larynx opens into a trachea. The **trachea** is a long, cylindrical and flexible tube running back-

ward through the neck. On entering the thoracic cavity, the trachea expands into a **syrinx** or **voice box**. Later it divides into two **bronchi**, one for each lung. The walls of tracheal and bronchial tubes are supported by a series of closely set cartilagenous rings. Each bronchus enters a bright red lung. The bronchus divides and subdivides into smaller branches, ultimately ending in fine air capillaries. **Lungs** are solid spongy organs. They do not hang freely in the thoracic cavity but are lodged firmly in the ribs. Some of the branchial tubes pass through the lungs and communicate with the air cavities in the bone. There are nine **air sacs**. They are a median interclavicular, a pair of cervical, two pairs of thoracic and a pair of abdominal air sacs.

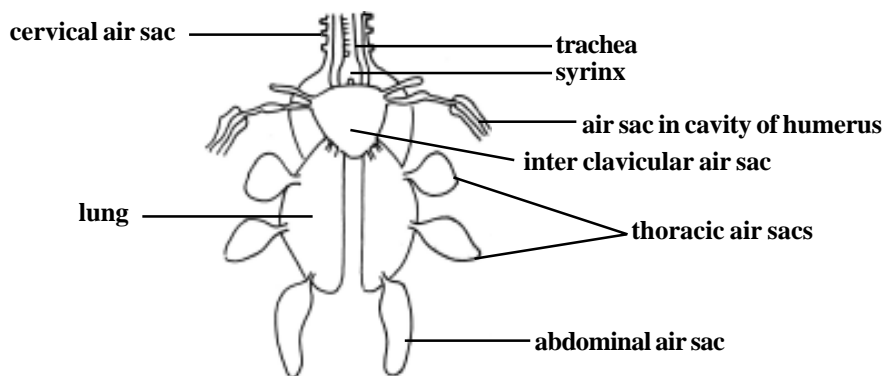

Fig. 1.3.16. Pigeon - Lungs and air sacs

The air sacs help to maintain high body temperatures. They make the body lighter and help in flight.

Mechanism of Respiration :-

In birds the expiration is an active process. The process of inspiration is passive. In a resting bird, the sternum is moved up and down with the help of **intercostal** and the **abdominal muscles**.

During flight, the **sternum** is rendered immovable due to the support of wings, but the body cavity is raised and lowered by the action of wings and by the lowering of the vertebral column.

Circulatory system :-

The **heart** is four chambered, with two **auricles** and two **ventricles**. There is complete separation of the oxygenated and non-oxygenated blood. Birds have two distinct circulations as **arterial** and **venous** systems.

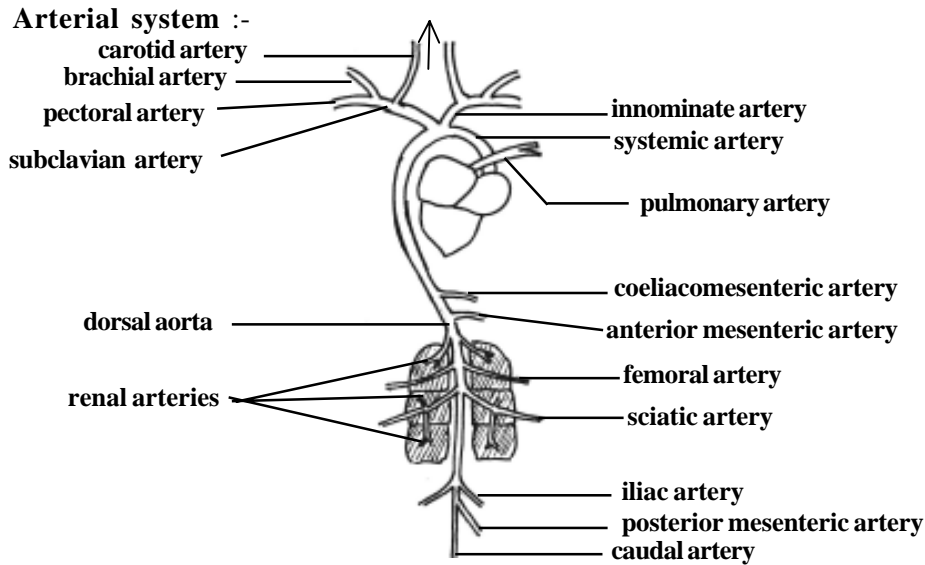

Fig. 1.3.17. Pigeon - arterial system

From the right ventricle arises the **pulmonary artery** carrying deoxygenated blood to the lungs for purification. An **aorta** arises from the left ventricle (right systemic). It carries oxygenated blood to various regions of the body through several arteries.

Venous system :-

The deoxygenated blood from various regions of the body are collected by several veins. Finally these veins take the blood to the right auricle through the two **precaval** and a single **postcaval** veins.

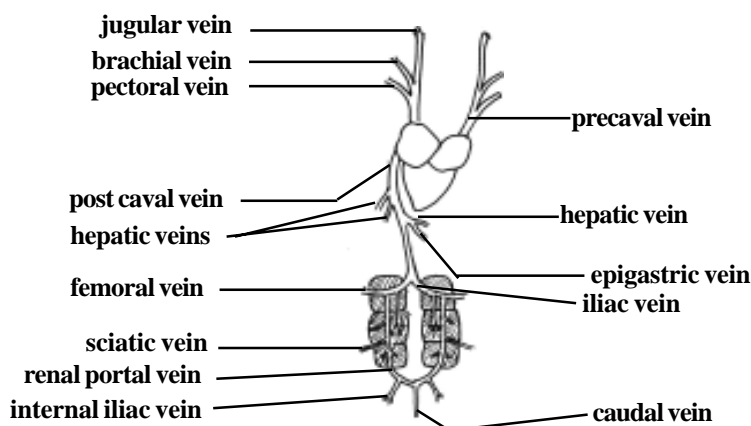

Fig. 1.3.18. Pigeon - venous system

Nervous system :-

The brain is divisible into the fore-, mid- and hind brains. The **cerebral hemispheres** are distinct. They are round and large in size. The **olfactory lobes** are very small and they do not contain cavities. The **diencephalon** is hidden from the view by the forward prolongation of the **cerebellum**. The diencephalon has the **pineal body** dorsally and **infundibulum** and **pituitary body** ventrally. The **optic lobes** are lateral in position owing to the large size of the cerebral hemispheres and cerebellum. The **medulla oblongata** instead of being continued backwards as in other tetrapods, descends almost vertically from the cerebellum

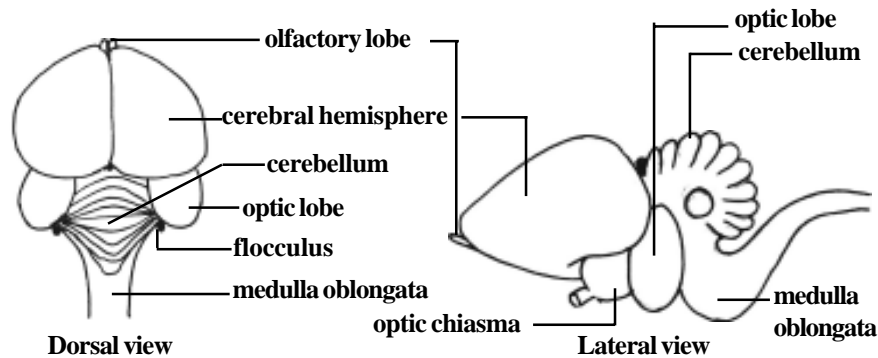

Fig. 1.3.19. Pigeon - Brain

Sense organ :-

In pigeon the **olfactory** sense is poor. There is no external ear. The **tympanum** is slightly sunken from the surface of the skin.

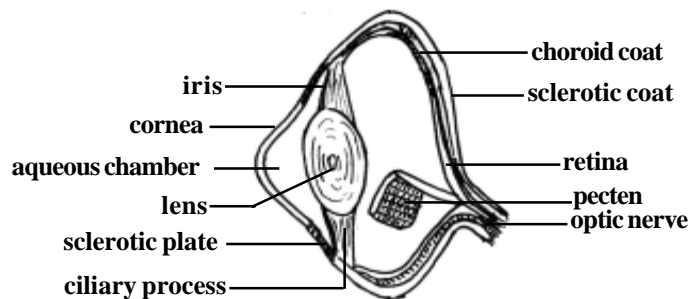

Fig. 1.3.20. Eye of Pigeon

The **eyes** are large. During flight the eyes and their shape are protected by unique **sclerotic plates** of the outer eye layer. The **nictitating membrane** slides over the eyeball and presumably protects the cornea by

closing it, during flight. Inside the eye, a vascular pigmented process projects into the vitreous body. It is known as the **pecten**. It arises from the point of entry of the optic nerve into the eye ball. Its function is not definitely known, but possibly it may help in long distance vision.

Urinogenital system :-

The excretory organs are a pair of **kidneys**. They are dark red, three lobed structures. They open separately into the **urodaeum** of the cloaca through two different **ureters**. There is no **urinary bladder**. The urine is excreted in the form of uric acid, a semi solid white mass discharged along with faeces through the cloacal aperture.

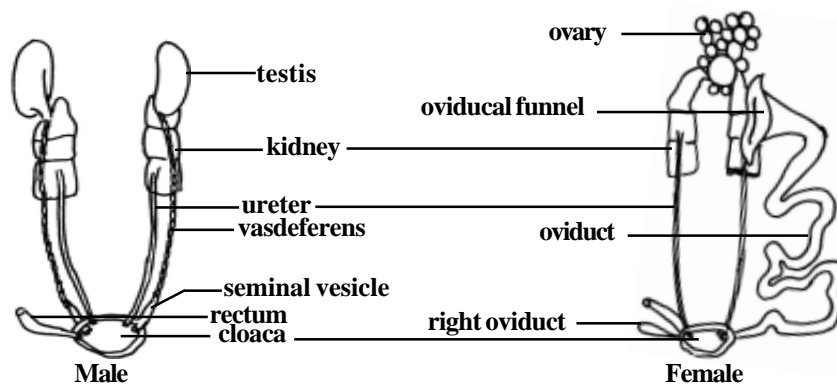

Fig. 1.3.21. Pigeon - Urinogenital system

Male Reproductive system :-

The male has a pair of oval **testes**. From each testis, a duct, the **vasdeferens**, passes back and opens into the cloaca. The vas deferens is dilated at its posterior end into a **seminal vesicle**. There is no **copulatory organ**.

Female reproductive organs :-

Only the left **ovary** persists in the adult. The right ovary disappears during development. The ovary and the **oviduct** of only one side are functional during breeding season.

Unit - 1

Part A

Choose the right answer :-

- The theme of the world summit on environment held in Johannesburg in 2002 was
 - only one earth
 - our common future
 - sustainable earth
 - energy crisis
- The introduction of phylogeny in taxonomy was made by
 - Cuvier
 - Lamarck
 - Charles Darwin
 - Linnaeus
- If two or more workers describe the same organism using different names it results in
 - homonyms
 - synonyms
 - a valid name
 - nomenclature
- Which among the following is a pseudocoelomate ?
 - platyhelminthes
 - Annelids
 - Mollusca
 - Nematoda
- Five Kingdom concept does not include
 - fungi
 - viruses
 - flowering plants
 - bacteria
- Which among the following is considered 'a blood fluke'
 - Schistostoma
 - Taenia solium
 - Fasciola
 - Ascaris
- The head formation or cephalization happened for the first time in the Phylum
 - Arthropoda
 - Annelida
 - Mollusca
 - Echinodermata
- Which among the following is considered as a connecting link between Annelida and Arthropoda
 - Centipede
 - Cockroach
 - Peripatus
 - Spiders
- The characteristic feature of echinoderms is the possession of
 - compound eye
 - absence of coelom
 - diploblastic condition
 - water vascular system

10. Acrania refers to
- a) fishes b) birds
c) chordates d) prochordates
11. The segmented body muscles in fishes are called as
- a) myotomes b) smooth muscles
c) skeletal muscles d) visceral muscles
12. Which among the following is considered as a defeated group
- a) amphibians b) reptiles
c) mammals d) fishes
13. The amniotes are characterised by the presence of
- a) four legs b) amphibious life
c) egg membranes d) metamorphosis
14. Which among the following is not a character of mammals
- a) diaphragm b) right aortic arch
c) mammary glands d) corpus collosum
15. The infective stage of plasmodium is
- a) cryptozoite b) amoebula
c) sporozoite d) merozoite
16. In earthworm the clitellum is present in segments
- a) 5 to 10 b) 14 to 17
c) 13 to 18 d) 20 to 25
17. The muscle fold found in the dorsal wall in the intestine of the earthworm is
- a) diaphragm b) Typhlosole
c) myotome d) ommatidium
18. The chlorogogen cells on the wall of the intestine in earth worm is meant for
- a) digestion b) circulation
c) excretion d) reproduction
19. The uropygeal gland of pigeon are found
- a) above the tail b) in the alimentary canal
c) in the brain d) in the reproductive system
20. The hollow bones of birds are called as
- a) pneumatic bones b) fused bones
c) skull bones d) limb bones

Part B

Give very short answers.

1. Define biosphere?
2. Why do we consider Aristotle as the father of biological classification?
3. What is the characteristic feature of biological taxonomy?
4. What are triploblastic animals?
5. Why do we call nematocysts as stinging cells?
6. What is a trochophore?
7. What are amniotes?
8. Why do we call birds as glorified reptiles?
9. Name the subclasses under mammalia.
10. Mention any one characteristic feature of the primates.
11. What are cryptozoites?
12. What is Ookinete?
13. What is tertian malaria?
14. What are 'lateral hearts'?
15. What is 'pecten'?

Part C

Answer briefly

1. Provide a brief account on the biodiversity in India.
2. What are the various concepts of species?
3. Give an account of the basic principles of nomenclature.
4. Differentiate bracketed and indented keys for identification with a suitable example.
5. Write notes on Phylum Annelida.
6. Give a brief account on Protochordates.
7. Write notes on Primates.
8. What are the types of malaria?
9. Provide an account on external openings on the body of earthworm .
10. Write notes on flight muscles in pigeon.

Part D

Answer in detail

1. Define species and provide an account on various animal groups.
2. Write an essay on the various methods of taxonomy.
3. Give a detailed account on the general characters chordates.
4. Explain the life cycle of Plasmodium in man.
5. Describe the external features of *Columba livia*.
6. Give a detailed account on the reproductive system and the process of reproduction in earthworms.

Classify giving reasons.

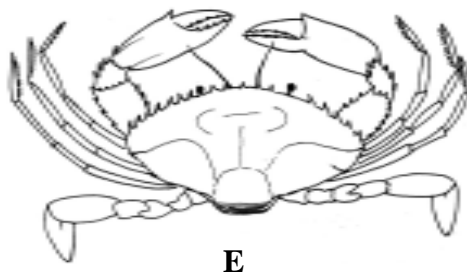
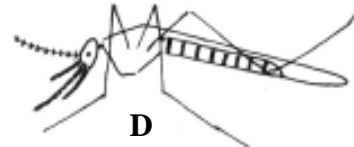
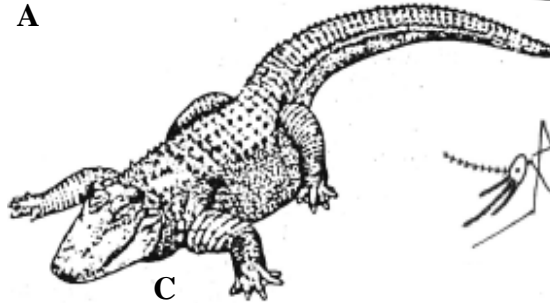
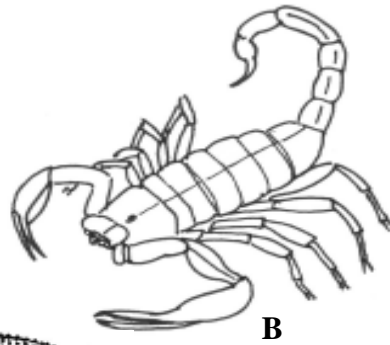
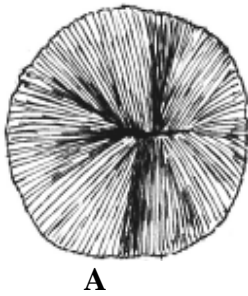

2. Cell Biology

‘All living things are made up of cells’. ‘The cell is the basic unit of structure and function’. These generalised statements are known as **Cell theory**. This theory was forwarded by **Mathias Schleiden** and **Theodor Schwann** in 1838 - 39.

Today the cell theory includes four more ideas :

- the cells are the building block of structures in living things
- the cell is derived from other cells by division
- the cell contains information that is used as instructions for growth, development and functioning
- the cell is the functioning unit of life; the chemical reactions of life take place within cells.

The idea and concept of cell biology evolved during the 19th century as a result of gradual advancement in the field of microscopy and biochemistry. Today the study of the structure of cells (cytology) is part of a major branch of biology known as **cell biology**. Due to its wide application many new branches have sprung up in biology. Some of the new branches related to cytology are, **Cytotaxonomy**, **Cytogenetics**, **Cell physiology**, **Cytochemistry**, **Molecular Biology**, **Cytopathology** and **Cytoecology**.

2.1 Microscopy

The cells are very minute and complex organisations. The small dimensions and transparent nature of cell and its organelles pose problems to cell biologists trying to understand its organisation and functioning. Various instruments and techniques have been developed to study cell structure, molecular organization and function.

The diameters of majority of cells range from 5-500 μm , but most are between 10-150 μm . The Systeme International (SI) units of length are

1 metre (m)	=	1000 millimetres (mm)
1 mm (10^{-3}m)	=	1000 micrometres (μm)
1 μm (10^{-6}m)	=	1000 nanometres (nm)
1 nm (10^{-9}m)	=	1000 picometres (pm)

The Angstrom (\AA) is 10^{-10} m. It is sometimes used to record the thickness of cell membranes and the sizes of macromolecules.

While viewing objects, human eyes have limited distinguishing or resolving power. The ability to reveal minute details is expressed in terms of **limit of resolution**. It is “the smallest distance that may separate two points on an object and still permit their observation as distinct separate points”. The resolving power of naked human eye is 0.1 mm or 100 μm . It means that we cannot differentiate any points that are closer than this. Hence we need instruments capable of high resolution to see smaller objects.

Power of **magnification** is different from resolving power. Magnification is ‘the increase in size of optical image over the size of the object being viewed’. Increased magnification without improved resolution results only in a large blurred image. The human eye has no power of magnification.

The first useful compound microscope was invented by **Francis Janssen** and **Zacharias Janssen** in 1590. It had two lenses with magnification powers between 10x and 30x. **Galileo Galilei** (1564-1642) invented a simple microscope to study the compound eye of insects. His microscope had only one magnifying lens. **Marcello Malpighi** (1628-1694) an Italian microanatomist used a microscope to study organ tissues of animals. **Robert Hooke** an English microscopist in 1665 examined a slice of cork tissue under a compound microscope built by him. He coined the term “cells” to honey comb of cells in cork tissue.

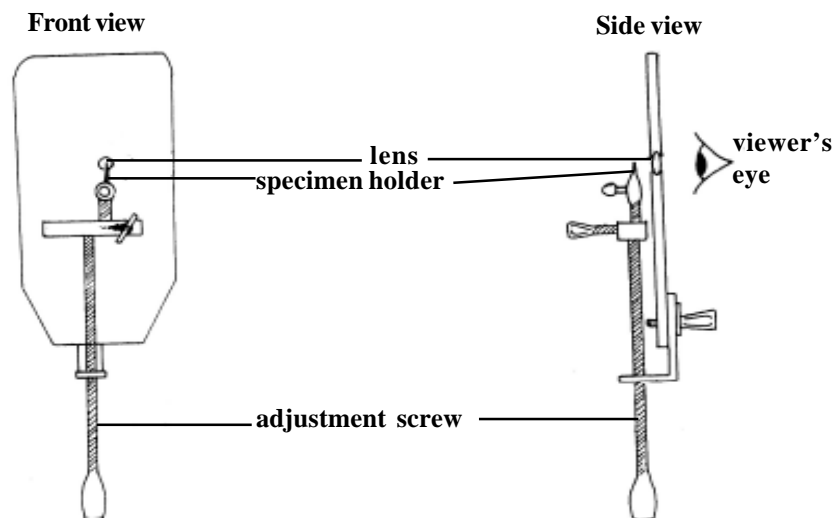

Fig.2.1.1. Van Leeuwenhoek's simple microscope

Anton van Leeuwenhoek (1632-1723) improved the quality of lenses used in microscopes. His microscopes achieved magnification upto 300x. He was the first to observe free living cells.

Further advancements in cell biology were made by improving the quality of compound microscopes.

Compound light microscope

This microscope uses visible light for illuminating the object. It contains glass lenses that magnify the image of the object and focus the light on the retina of the observer's eye. It has two lenses one at each end of a hollow tube. The lens closer to the object being viewed is called **objective lens**. The lens closer to the eye is called **ocular lens** or **eyepiece**. The object is illuminated by light beneath it. A third lens called **condenser lens** is located between the object and the light source and it serve to focus the light on the object.

Dark field microscope

This type of microscope is useful for viewing suspensions of bacteria. It has a special **condenser** that allows only rays of light scattered by structures within specimen. The result is an image that appears bright against a dark background, with a high degree of contrast. The process is similar to seeing dust particles floating in a sunbeam.

Phase contrast microscope

The phase contrast microscope has special fitments to the objective lens and sub stage condenser, the effect of which is to exaggerate the structural differences between the cell components. As a consequence, the structures within living, unstained cells become visible in high contrast and with good resolution. Phase contrast microscopy avoids the need to kill cells or to add dye to a specimen before it is observed microscopically.

Oil - immersion microscopy

In oil-immersion microscopy the light gathering properties of the objective lens are enhanced by placing oil in the space between the slide and objective lens. Normally the technique is used to view permanently mounted specimens.

The oil immersion lens gives higher magnification than the normal high-power objective lens.

Electron microscopy.

The electron microscopy uses the much shorter wavelengths of electrons to achieve resolutions as low as 3\AA . **Electromagnetic coils** (ie., magnetic lenses) are used to control and focus a beam of electrons accelerated from a heated metal wire by high voltages, in the range of 20,000 to 100,000 volts. The electrons are made to pass through the specimen. Electrons that pass out of the object are focused by an **objective coil** ('lens'). Finally a magnified image is produced by a **projector coil** or 'lens'. The final image is viewed on a screen or is recorded on photographic film to produce **electron micrograph**. This type of electron microscope is called transmission electron microscope (TEM)

In a compound light microscope, the image is formed due to differences in light absorption. The electron microscope forms images as a result of differences in the way electrons are scattered by various regions of the object.

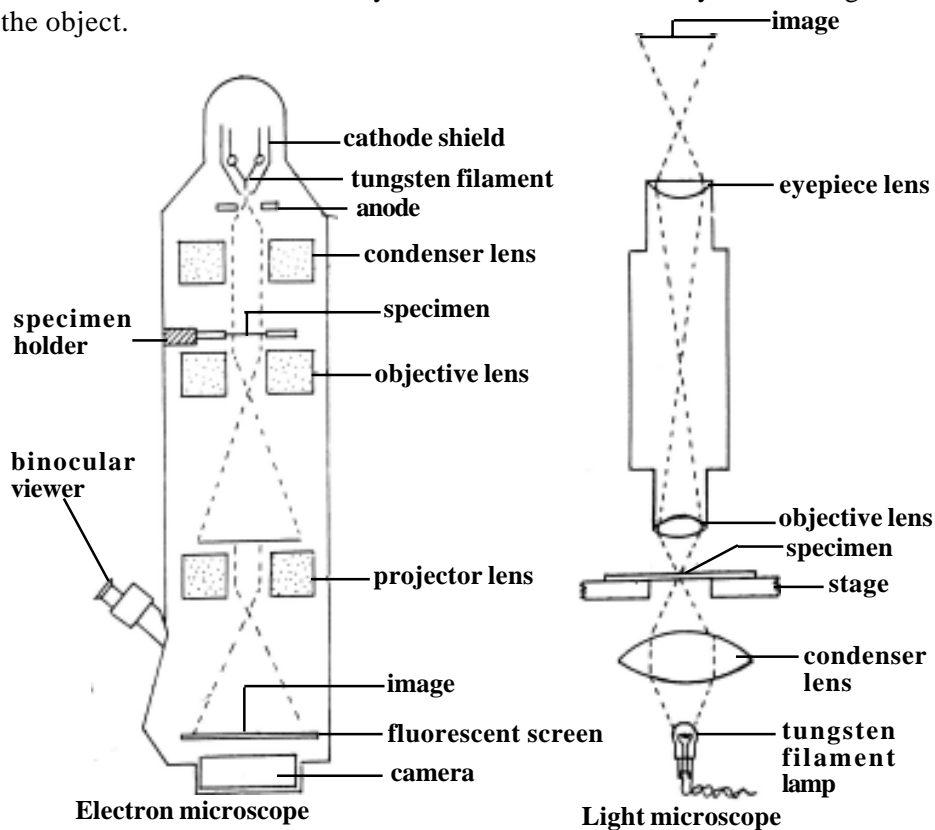

Fig.2.1.2. Comparison of the components and pathways of radiation

The degree to which electrons are scattered is determined by the thickness and atomic density of the object. Hence the specimens used in electron microscopy must be extremely thin. Living cells which are wet cannot be viewed in electron microscope.

Scanning electron microscopy (SEM)

This microscope has less resolution power than the TEM (ie., about 200Å). However it is a very effective tool to study the surface topography of a specimen. The whole specimen is scanned by a beam of electrons. An image is created by the electrons reflected from the surface of the specimen. Scanning electron micrographs show depth of focus and a three dimensional image of the object.

2.1.2 Cytological Techniques

Cells are transparent and optically homogeneous organisations. They can be observed either directly or after preservation. For direct observation, the specimen needs sufficient contrast. Direct observation is possible by using vital stains.

Vital stains :- Vital dyes or stains are taken up by living cells without killing them. They selectively stain intracellular structures without affecting cellular metabolism and function. For example, **Janus green B** selectively stains mitochondria, Golgi apparatus, nuclear chromatin in a dividing cell can be stained by **methylene blue**; **Neutral Red** dye or **Congo Red** dye can be used to stain yeast cells.

Preserved and stained tissues :- For detailed microscopic study, tissues containing cells are passed through various stages. The stages of cell preparation on a glass slide involves killing, fixation, dehydration, embedding, sectioning, staining and mounting.

1). **Killing and fixation** :- This process causes sudden death of cells or tissues and preserves freshly killed tissues in as lifelike a condition as possible. A good fixative prevents bacterial decay and autolysis. It will also make

different cell components more visible and prepare the cell for staining. The commonly used fixatives are Acetic acid, Formaldehyde, Bouin's solution and Carnoy's fluid.

2). **Dehydration** :- In this process water vapour are removed from cells or tissues using chemical agents. It is done by using ethanol and benzene.

3). **Embedding** :- The tissues are infiltrated with molten paraffin wax. It hardens up on cooling and provides enough support to allow thin sections. Very thin sections need to be taken for electron microscopy. Hence plastics are used for embedding.

4). **Sectioning** :- The embedding material is cut into thin sections of needed thickness. It is done by using an instrument called **microtome**.

5). **Staining** :- The sections are immersed in dyes that stain some structures better than others. For example, cytoplasm stains pink with eosin. Nucleus stains blue with haematoxylin or red with safranin.

6). **Dehydration** :- Stained sections are immersed in ethanol to remove water. The tissue becomes more transparent. Dehydration is done gradually by using a series of increasing concentrations of ethanol in water. Finally the section is placed in 'absolute' alcohol.

7). **Mounting** :- Cleaned sections are mounted on a slide using a suitable medium like canada balsam. A cover slip is added and the medium is allowed to dry.

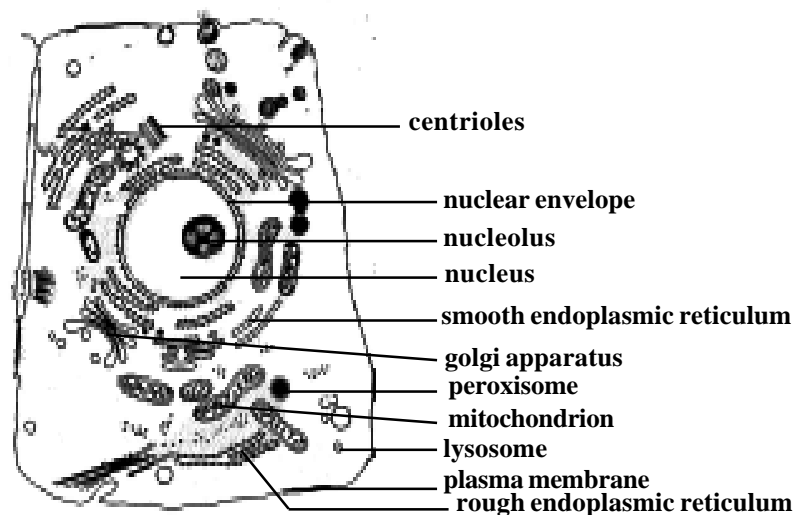

Fig.2.1.3. Ultra structure of a typical animal cell

2.2.1 Plasma Membrane

It is the outer limiting membrane of both prokaryotic and eukaryotic cells. It is an ultra thin, elastic, living membrane. Plasma membrane is a dynamic and selective transport barrier.

Since the plasma membrane is ultra thin, it could be observed only under electron microscope. Structure of the membrane is studied by isolating the same from the cell and conducting biochemical investigations.

In 1895 **Overton** suggested that the membrane is made of fatty substances. Other workers later concluded that two layers of lipid were present in the cell membrane. According to a model proposed by **Danielli** and **Davson** in 1935, the **lipid bilayer** of the membrane was coated on either side with protein.

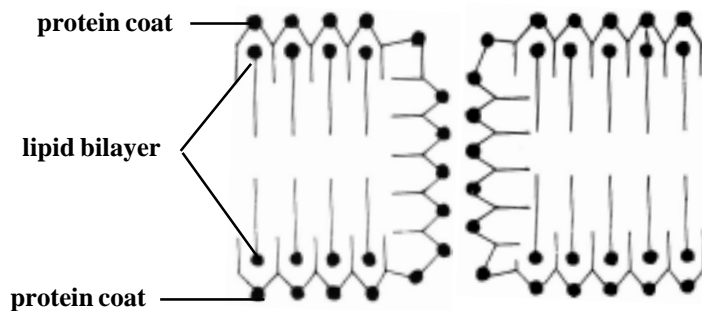

Fig.2.2.1. The Danielli-Davson model of the cell membrane

In 1960, **Robertson** using electronmicrographs proposed a **unit membrane hypothesis**. According to this hypothesis the two outer layers of **protein** are about 2 nm thick and appear densely granular. They enclose a clear central area of about 3.5 nm wide consisting of **lipids**. The lipids are mainly **phospholipid** molecules.

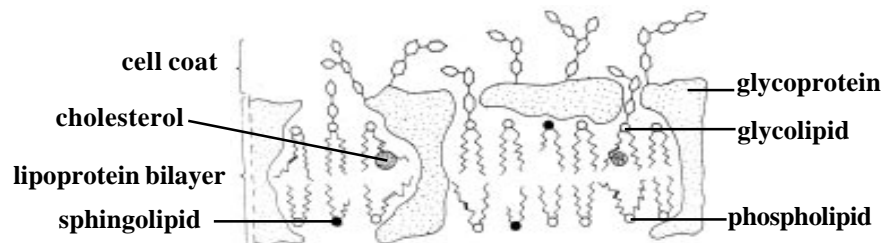

Fig.2.2.2. The fluid-mosaic model of the cell membrane

Singer and Nicholson (1972) have proposed a **fluid mosaic model** for the plasma membrane. The fluid mosaic membrane is a dynamic structure. In this structure much of the protein molecules float about. Some of them are anchored to the organelles within the cell. Lipid molecules also move about. 'Fluid mosaic model' is applied to all biological membranes in general.

The cell membrane controls the passage of materials both into and out of the cell. It regulates the passage of water and dissolved substances. Water passes through the membrane by **Osmosis**. Water soluble substances cross the membrane by **diffusion** or by **active transport**. Many water soluble solutes are transported by carrier proteins. Lipid soluble compounds pass more quickly by dissolving in the phospholipid layer.

2.2.2 Mitochondria

The mitochondria are filamentous or granular cytoplasmic organelles of all aerobic cells of higher animals and plants. They are also found in micro organisms including Algae, Protozoa and Fungi.

They were first observed by **Kolliker** in 1850 as granular structures in the striated muscles. The name '**mitochondria**' was given to them by **Benda** (1897-98). Various steps of glycolysis in mitochondria was discovered by two German biochemists **Embden** and **Meyerhof**. Embden got the Nobel Prize in 1922. **Sir Hans Adolph Krebs**, in 1937 found out various reactions of citric acid cycle. **Kennedy** and **Lehninger** (1948-50) showed that **Citric acid cycle**, **oxidative phosphorylation** and **fatty acid oxidation** took place in the mitochondria.

The number of mitochondria in a cell depends on the type and functional state of the cell. Certain cells contain large number of mitochondria e.g., eggs of sea urchin contain 140,000-150,000 mitochondria. Oocytes of amphibians contain 300,000 mitochondria. Liver cells of rat contain only 500-1600 mitochondria. Some algal cells may contain only one mitochondrion.

The mitochondria may be filamentous or granular in shape. They vary in size from 0.5 μm to 2.0 μm . Due to their minute nature they can not be seen under light microscope.

Each mitochondrion is bound by two highly specialized membranes. The outer membrane is smooth. It is separated from the inner membrane by a 6-8 nm wide space. The **inner membrane** is highly convoluted, forming a series of inflodings known as **cristae**.

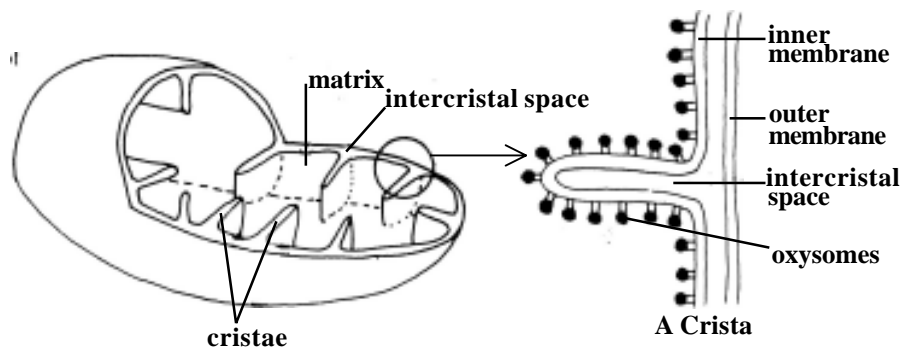

Fig.2.2.3. Three dimensional structure of a mitochondrion

Thus mitochondria are double membrane envelopes. The inner membrane divides the mitochondrial space into two distinct chambers. The outer compartment is the **peri-mitochondrial space**. It is found between outer and inner membranes. The inner compartment is the **matrix space**. It is filled with a dense gel like substance called **mitochondrial matrix**. The matrix contains **lipids, proteins and circular DNA molecules**.

The outer and inner membranes, intermembrane space and mitochondrial matrix contain several enzymes. Hence the mitochondria perform several important functions such as **oxidation, dehydrogenation, oxidative phosphorylation and respiratory chain** of the cell.



Fig.2.2.4. Mitochondria

Since mitochondria play a key role in the oxidation of carbohydrates and fats, they are considered as the actual **respiratory organs** of the cells. During such biological oxidations large amount of energy is released. The energy is utilized by the mitochondria for synthesis of the energy rich compound known as **adenosine tri phosphate** or **ATP**. Due to this function, the mitochondria are also known as "**power houses**" of the cell. In animal cells mitochondria produce 95 % of ATP molecules.

2.2.3 Ribosomes

The ribosomes are small dense, rounded and granular particles. They contain **ribonucleoprotein**. They occur either freely in the matrix of the mitochondria, chloroplast and cytoplasm or remain attached with the membrane of the endoplasmic reticulum and nucleus.

The ribosomes were described by **G.E.Palade** in 1952. The name '**ribosome**' was coined by **R. B. Roberts** in 1958.

The ribosomes occur in both prokaryotic and eukaryotic cells. In the cells in which active protein synthesis takes place, the ribosomes remain attached with the membranes of the endoplasmic reticulum. The cells where such active synthesis happens are pancreatic cells, hepatic cells, osteoblasts, serous cells of submaxillary gland, chief cells of the glandular stomach, thyroid cells and mammary gland cells.

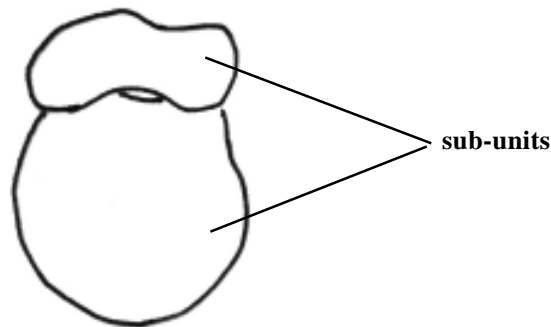

Fig.2.2.5. Ribosome

The ribosomes are spheroid structures with a diameter of 150 to 250 Å. Each ribosome is composed of two subunits. One subunit is large in size and has a dome like shape. The other ribosomal subunit is smaller in size and it occurs above the larger subunit forming a cap-like structure.

The ribosomes are chemically composed of **RNA** and **proteins**. The **ribosomal RNA (rRNA)** play a central role in the process of **protein synthesis**. The ribosomal proteins enhance the catalytic function of the rRNA. The functioning of rRNA is under genetic control.

2.2.4 Endoplasmic Reticulum. (ER)

Electron microscopic study of sectioned cells has revealed the presence of a three dimensional network of sac-like and tubular cavities called **cisternae** bounded by a unit membrane inside the cell. Since these structures are concentrated in the endoplasmic portion of the cytoplasm, the entire organisation is called the **endoplasmic reticulum**. This name was coined by **Porter** in 1953.

The occurrence of ER varies from cell to cell. They are absent in erythrocytes, egg cells and embryonic cells.

The ER is the site of specific enzyme controlled biochemical reactions. Its outer surface carries numerous ribosomes. The presence of ribosomes gives a granular appearance. In this condition ER is described as **rough endoplasmic reticulum (RER)**. RER is the site of synthesis of proteins. Ribosomes are absent on **smooth endoplasmic reticulum (SER)**. SER is concerned with lipid metabolism.

Morphologically ER may occur in three forms namely 1. Lamellar form 2. Vesicular form and 3. Tubular form.

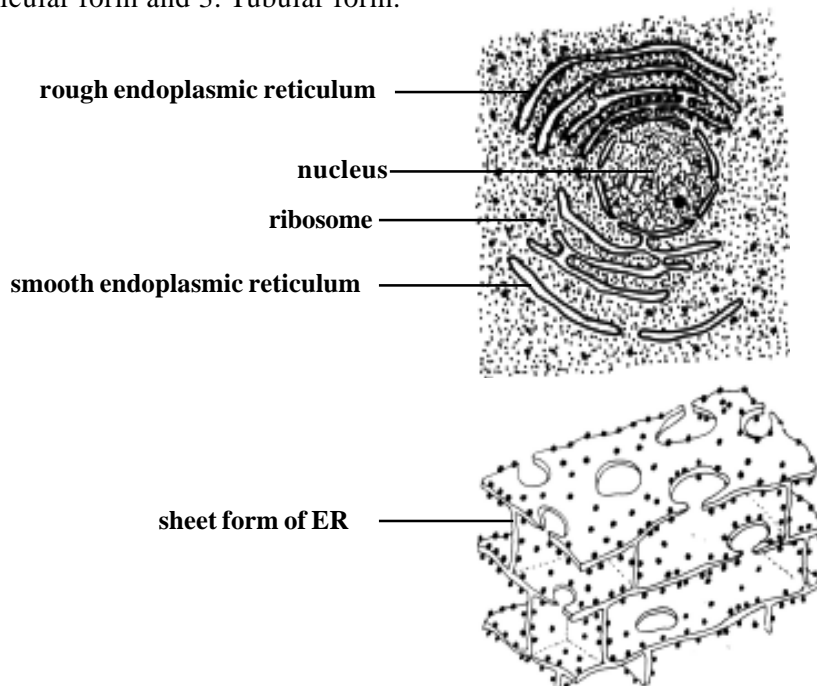

Fig.2.2.6. Endoplasmic reticulum

Lamellar form or Cisternae :- These are long, flat, sac like tubules. Their diameter is about 40-50 μm . The RER has a **synthetic** role. It is mostly seen in cells of pancreas, notochord and brain.

Vesicles :- These are oval, vacuolar structures. Their diameter is about 25-500 μm . They occur in most of the cells.

Tubules :- These are branched structures forming the reticular system along with the cisternae and vesicles. They have a diameter of 50-190 μm . They occur in almost all cells.

Functions :-

1. It provides skeletal framework to the cell.
2. It facilitates exchange of molecules by the process of osmosis, diffusion and active transport.
3. Enzymes of ER control several metabolic activities.
4. They serve as intracellular transporting system.
5. It conducts intra-cellular impulses.
6. It helps to form nuclear membrane after cell division.
7. SER synthesises lipids.

2.2.5 Golgi apparatus

The Golgi apparatus was discovered by an Italian neurologist, **Camillo Golgi** in 1873.

The Golgi apparatus occurs in almost all animal cells except red blood cells. Animal cells usually have a single Golgi apparatus. Some cells have more of Golgi apparatus.

In most of the ectodermal and endodermal cells it occurs in between the nucleus and the periphery. In nerve cells it occupies a circum-nuclear position.

The simplest unit of the Golgi apparatus is the **cisterna**. A cisterna is about 1 μm in diameter. It has a membrane bound space. This space accumulates secretions. Numerous such cisternae are associated with each other and appear in a lamellar arrangement. In the lamellar arrangement the space between each cisterna is 20-30 nm. A group of these cisternae is called the **dictyosome**. A group of dictyosomes constitute the Golgi apparatus.

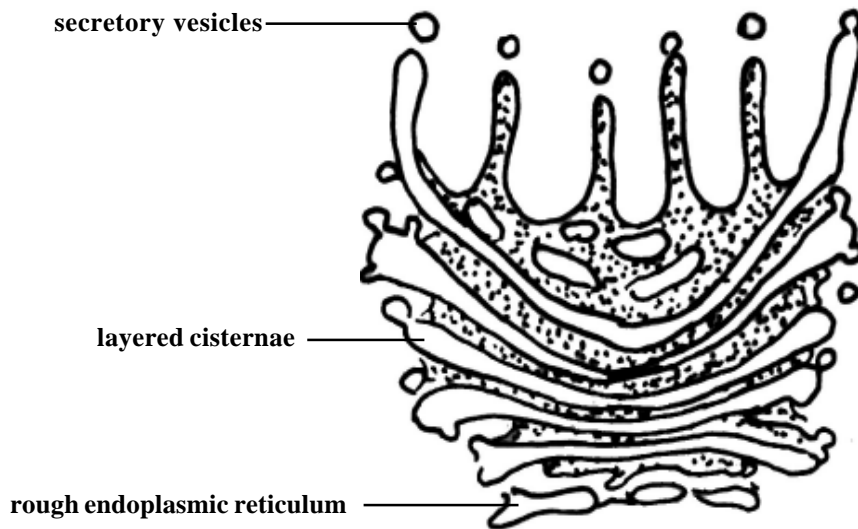

Fig.2.2.7. Golgi apparatus

Typically a Golgi apparatus appears as a complex arrangement of interconnecting tubules, vesicles and cisternae.

The Golgi apparatus is the site of synthesis of biochemicals. They also collect proteins and lipids made in the ER and add additional substances.

2.2.6 Lysosomes

These are tiny vesicles surrounded by a membrane. Lysosomes are involved in intracellular digestion and are primarily meant for destroying unwanted and aged organelles inside the cells.

Lysosomes were initially named as 'perinuclear dense bodies'. The name 'lysosome' was coined by C.de Duve in 1955.

Lysosomes occur in all animal cells. However they are not found in mature mammalian erythrocytes. Muscle cells contain very few lysosomes. They are numerous in epithelial cells of secretory and excretory organs.

Each lysosome is a round structure. It is filled with a dense material. Their shapes and densities vary. Their size ranges from 0.2 to 5 μm .

Recent studies reveal that lysosomes may contain upto 40 types of hydrolytic enzymes.

The enzymes are mostly **proteases, nucleases, glycosidases, lipases, phospholipases, phosphatases and sulphatases.**

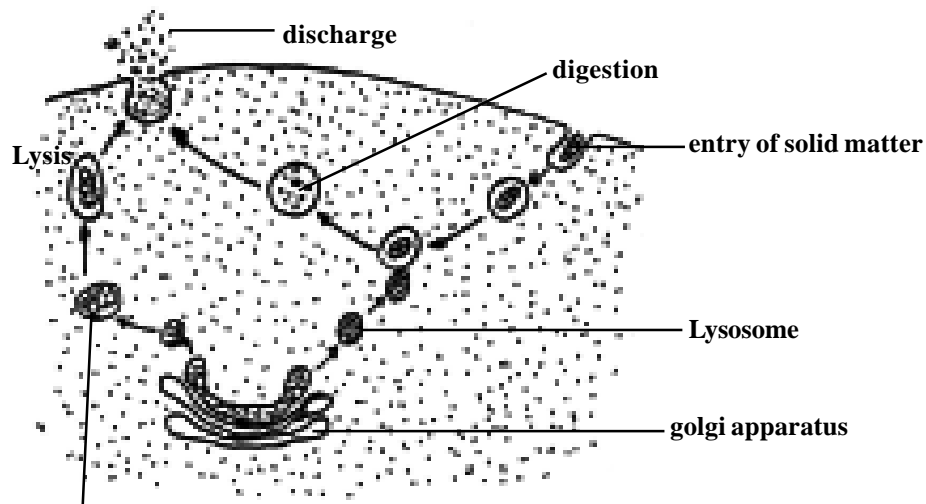

Fig.2.2.8. Lysosomes - in action

Lysosomes originate either from the Golgi apparatus or directly from the endoplasmic reticulum. The enzymes they contain are used in the **dissolution** and **digestion** of redundant structures or damaged macromolecules from within or outside the cell. For example, when an animal cell ingests food into a food vacuole, lysosomes fuse with the vacuole and break down the contents. Their enzymes digest carbohydrates, fat and proteins. The glands in some digestive organs package their digestive enzymes in lysosomes before releasing them outside the membrane. When a cell dies its own lysosomes release the enzymes that digest the remains of the cell in a process known as **autolysis**.

Peroxisomes

These are spherical organelles bounded by a single membrane. They are found in the cells of Protozoa, fungi, plants, liver and kidney of vertebrates. The name peroxisomes was coined by **C.de Duve** and **P. Baudhuin** (1966)

Peroxisomes contain catalase, an enzyme that catalyses the decomposition of hydrogen peroxide to the harmless products, water and oxygen.

Hydrogen peroxide is a by-product of certain reactions of metabolism. It is potentially a very harmful oxidising agent.

2.2.7 Centrioles

The centrioles are two cylindrical, microtubular structures found near the nucleus. When a centriole supports a flagellum or cilium, it is called the **basal body**.

The centrioles occur in most of the animal cells, algal cells and some fern cells. They are absent in prokaryotes, red algae, yeast cells and flowering plants and some non-flagellated or non-ciliated protozoans.

The centrioles range in size from 0.15-0.25 μm in diameter. They are usually 0.3-0.7 μm in length.

Each centriole and basal body is formed of nine triplet **microtubules** equally spaced around a perimeter. Each microtubule has a diameter of 200-260 \AA in diameter.

The microtubules are made up of a structural protein, **tubulin**, along with lipid molecules.

It was initially considered that new centrioles arise by the division of existing centrioles. This idea is no longer accepted. It appears that new centrioles are produced **de novo** or are synthesized using an existing centriole as a template.

In most of the animal cells the centrioles are the focal point for the **centrosome**. The centrosome organizes cytoplasmic microtubules during interphase in mitosis. It provides the two poles of the **mitotic spindle**.

The centrioles form the basal body and the cilia. In spermatozoon one centriole gives rise to the tail fibre or flagellum. The centrioles are also involved in ciliary and flagellar activity.

2.2.8 Nucleus

The nucleus is the most important organelle of cell. It controls all metabolic processes and hereditary activities of the cell.

The nucleus was first discovered and named by **Robert Brown** in 1833. The occurrence of a nuclear membrane was first revealed by **O. Hertwig** in 1893.

The nucleus is found in all the eukaryotic cells of plants and animals.

However some eukaryotic cells such as the sieve tubes of higher plants and mammalian erythrocytes have no nucleus.

Usually the cells contain single nucleus (**mononucleate**). However certain cells may have more than one nuclei. Accordingly they may be called **binucleate** or **polynucleate** cells. The polynucleate cells of the animals are called **syncytial cells** (Osteoblast cells)

The shape of the nucleus may be **spherical, elliptical** or **discoidal**. In certain cells the nucleus is irregular in shape.

The size of the nucleus may vary from 3 μm to 25 μm in diameter. The size is directly proportional to that of the cytoplasm. Nuclear size may also be determined by the number of chromosomes or ploidy. The nucleus of the haploid cells are smaller than that of the diploid cells.

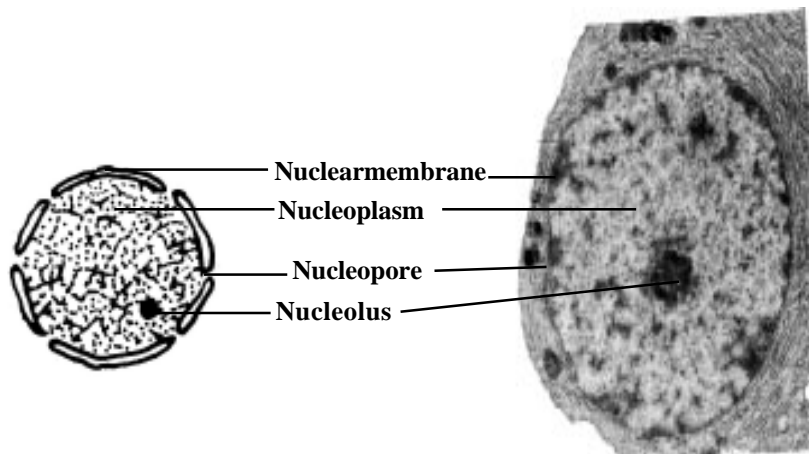

Fig.2.2.9. Nucleus

Fig.2.2.10. TEM of the Nucleus

The nucleus is surrounded by a **nuclear envelope**. This envelope is comprised of two membranes of 5-10 nm thickness. The **inner nuclear membrane** supports a fibrous sheath called the **nuclear lamina**. The inner nuclear membrane is surrounded by the outer nuclear membrane. The space between the inner and outer membranes is known as **perinuclear space**. It is a 10 to 50 nm wide fluid filled compartment.

The **nuclear lamina** is a protein meshwork. It is a very dynamic structure.

The nuclear envelope is perforated by **nuclear pores**. Each pore has a diameter between 10 nm to 100 nm. It has been calculated that the nuclear pores account for 5 to 15 percent of the surface area of the nuclear membrane. There is continuous movement of molecules across the nuclear envelope through the pores.

The nucleus is filled with a transparent semisolid matrix known as **nucleoplasm** or **nuclear sap**. The chromatin threads and the nucleolus remain suspended in the nucleoplasm. The nucleoplasm is composed of nucleoproteins, proteins, enzymes and minerals.

The nucleoplasm contains several thread like coiled structures. These are the **chromatin fibres**. During the cell division they become thick ribbon like structures known as **chromosomes**. The chromatin is made up of **Deoxy - ribose nucleic acid** (DNA) and proteins.

The nucleus contains one or more spherical colloidal structures called **nucleoli**. The size of nucleolus is related to the synthetic activity of the cell. The number of nucleoli in the cells may be one, two or four. Chemically, nucleolus contains DNA of nucleolar origin, four types rRNA, 70 types of ribosomal proteins, RNA binding proteins and RNA splicing nucleoproteins.

Ribosomal subunits are synthesized in the nucleolus. **Initiation, production** and **maturation** stages of ribosomal formation happen in three distinct regions of the nucleolus.

Chromosomes

The chromatin fibres get condensed into chromosomes during cell divisions. They are capable of self-reproduction and they play an important role in heredity.

The nucleus was first observed and described by **Karl Nagli** (1842) in the nuclei of plant cells. Chromosomes and their role in cell division was first explained by **A. Schneider** (1873). In 1887 **Benden** and **Bovery** reported that the number of chromosomes for each species is constant. **T. H Morgan** and **H. Muller** in 1922 revealed the occurrence of nearly 2000 genetic factors on four chromosomes of *Drosophila*. In 1924, **Robert Feulgen** showed that chromosomes contain DNA.

The **number** of chromosomes is constant for a particular species. The reproductive cells such as sperm or ovum has one set of chromosomes and it is known as the **haploid** set(n). It is also known as the **genome**. The somatic or body cells contain two haploid set or genomes and are known as

the **diploid cells** (2n). The diploid condition is arrived at by the union of the haploid male and female gametes in the sexual reproduction.

Number of Chromosomes

Common name	Scientific name	Chromosome Number
Paramecium	<i>P. aurelia</i>	30-40
Hydra	<i>H. vulgaris</i>	32
Housefly	<i>Musca domestica</i>	12
Fruit fly	<i>Drosophila sps</i>	8
Pigeon	<i>Columba livia</i>	80
Gorilla	<i>Gorilla gorilla</i>	48
Man	<i>Homo sapiens</i>	46

The **size** of a chromosome can be measured during mitotic metaphase. It may range from 0.25 μm to 30 μm .

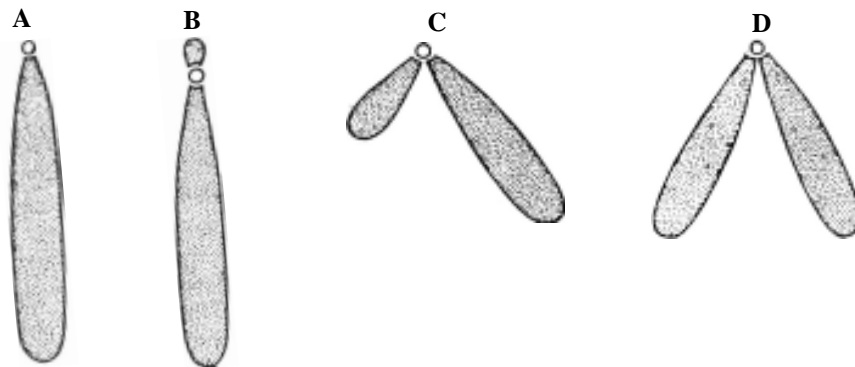

Fig.2.2.11. Types of chromosomes

A - Telocentric, B - Acrocentric, C - Submetacentric, D - Metacentric

The shape of the chromosome changes from phase to phase. Each chromosome has a clear zone, known as **centromere** or **kinetocore** along their length. The centromere divides the chromosome into two parts. Each part is called the chromosome arm. Thus according to the position of the centromere and nature of the chromosome arm, the chromosomes may be **Telocentric**, **Acrocentric**, **Submetacentric** and **Metacentric**.

2.3 Cancer biology

2.3.1

Cancer is a proliferation of cells which grow in an uncontrolled manner, invading local tissues and spreading widely through the blood or lymphatics to produce secondary deposits, or metastases in distant parts of the body.

The word 'cancer' comes from Latin, meaning a crab. A tumour was called a cancer because of swollen veins around the area resembling a crab's limbs. The study of cancer is called **Oncology**. Oncology is a word derived from the Greek, **onchos**, a lump, or tumour. The abnormal tissue growth is called neoplasm. If a **neoplasm** can cause harm by spreading, it is said to be **malignant**.

Cancer was known to ancient civilizations. However the disease as it would be defined today was established as an entity by German pathologists of 19th century. They described cellular nature of cancer and classified cancer. At the beginning of the 20th century, most major forms of cancer had been described. Further, attention was focused on finding the cause and introducing treatment. In 1775 **Pott** recognised cancer in chimney sweeps. He associated soot with cancer. From this time onwards **environmental** and **occupational hazards** were recognised as follows :

shale oil	skin cancer in workers
radio active ores	lung cancer in miners
beta-naphthylamine	bladder cancer in rubber industry workers
cigarettes	lung cancer

Later it was discovered that certain **viruses** can also cause cancer. One of the earliest virus, causing cancer, described was Rous sarcoma virus. Recently, human T-cell leukaemia has been found to be due to the virus HTLV-1.

Some forms of cancer can also be **inherited**. A rare eye tumour, retinoblastoma is inherited. It is a dominant character showing Mendelian inheritance.

Cancer biology

The knowledge of cancer biology is growing rapidly. Researches are being conducted to fully understand the development of cancer at the cellular

or molecular level. The available information is not sufficient for satisfactory treatment of cancer.

During normal development and growth the cells in our body divide mitotically and get differentiated to specialized cells of the tissues. The processes of cell mitosis, growth and differentiation are controlled by cellular genes. Cancer is caused due to mutation or abnormal activation of such genes. Such a mutation can happen in a single cell. Thus it may be **monoclonal** in origin. With further growth of cancer, additional mutations may occur in the daughter cells giving rise to subclones. The mutated cells may remain as heterogeneous cancer cells. Among these subclones some may have greater capacity and metastasize to distant tissues. They may also remain more resistant to damage from various anticancer treatments.

The cancer cells have characteristic properties. They can be differentiated from normal cells under microscopic observation. These cells have large nuclei. In each cancer cell, the ratio of nucleus to cytoplasm is high. They have prominent nucleoli. The cells can grow indefinitely in culture medium. As component cell of a tissue they remain less differentiated. Even after getting organised into tissues unlike other cells they do not lose their replicative capacity. Cancer cells have the ability to invade surrounding tissues.

The sequence of events that convert a normal cell into a cancer cell is called **carcinogenesis**. The process of carcinogenesis includes, initiation, growth, promotion, **conversion**, propagation and progression. Progression includes the processes of **invasion** and **metastasis**.

Mature cancers have relatively uncontrolled growth, behaviour. As other normal cells they do not show any of the normal intracellular and extracellular growth control mechanisms. Initially the cancer cells have an exponential growth. Gradually their growth surpasses blood vascular supply. This results in slowing down of growth.

Molecular biology of cancer

Techniques in molecular biology have helped in understanding the most intimate structure of the cancer cell. It has been found that at molecular level two mechanisms operate.

1. The parts of genome involved in cell growth become activated. These are called the '**proto-oncogenes**'. These strands of DNA induce malignant growth transformation in the cells. The conversion of proto-oncogenes into oncogenes can happen due to 'point mutations' on DNA. Further such cancer cells dis-

play chromosomal abnormalities such as duplication, deletions and translocations. Thus such alterations in gene arrangement can lead to generation of oncogenes.

Oncogenes of human tumours

Oncogene	Type of cancer	Activation mechanism
hox11	Acute T-cell leukemia	Translocation
erbB-2	Breast and ovarian carcinomas	Amplification
L-myc	Lung carcinoma	Amplification
ret	Thyroid carcinoma DNA	rearrangement.

A distinct mechanism by which oncogenes are activated in human tumors is **amplification**. It results in elevated gene expression. Gene amplification is very common in cancer cells. It occurs a thousand times more frequently than in normal cells. Molecular biologists are now working on the products of oncogenes.

2. The growth of normal cells is controlled by **suppressor genes**. In cancer, parts of the genome functioning as the suppressor gene are either lost or inactivated. Hence, negative regulators of cell proliferation are removed. It contributes to the abnormal proliferation of cells.

Gene	Type of cancer
APC	Colon / rectum carcinoma
BRCA 1	Breast and ovarian carcinoma
1 NK 4	Melanoma, lung carcinoma, brain tumors, leukemias, lymphoma
Rb	Retinoblastoma
PTEN	Brain tumors, kidney and lung carcinomas.

The protein products of the tumor suppressor genes normally inhibit cell proliferation. Inactivation of such genes therefore leads to tumor development.

The complete sequence of events required for the development of any human cancer is not yet known. But it is clear that both the **activation of oncogenes** and the **inactivation of tumor suppressor genes** are critical steps in tumor initiation and progression. Simultaneous effect on both the genes

will result in multiple genetic defect. It results in the increased proliferation, invasiveness and metastatic potential of cancer cells.

2.3.2 Types of cancer

Cancers are named according to the tissues from which they arise.

1. **Sarcoma** - Malignancy in structural tissues Ex: Osteosarcoma (bones), liposarcoma (fa).
2. **Carcinoma** - Epithelial cancers. Ex : Lung carcinoma, breast carcinoma.
3. **Lymphoma** - Lymphatic tissues
4. **Leukemia** - White blood cells.

Causes for Cancer (Etiology)

Majority of the cancers are caused by living habits and environmental factors.

1. **Tobacco** :- Nearly 35% of all cancer deaths are due to usage of tobacco in some form. At least 90% of lung cancer deaths are due to smoking. Smoking can also affect gastro-intestinal tract, pancreas, genito-urinary tract and upper respiratory passage. Snuff and chewing tobacco can affect mouth and respiratory tracts. Smoke inhaled by non-smokers (passive smoke) can also cause lung cancer and blood cancer.
2. Exposure to ionising radiations such as x-rays, gamma rays, uv rays can produce cancer. These radiations rupture DNA strands, causing mutations. Solar radiations can cause skin cancers.
3. Physical irritants, such as continued abrasion of the linings of the intestinal tract by some types of food can also lead to cancer. Dietary substances such as fat, high calorie intake of animal proteins, salted or smoked food can cause cancer in Breast, Colon, Stomach and Oesophagus.
4. Certain drugs if taken without medical advice can cause cancer.
5. Viruses and parasitic organisms like schistosoma, liverfluke can also affect.

Cancer and death

A severe onset of cancer ends in the death of a person. It is because of the unique characteristics of the cancer cells. The growth of normal cells is controlled by certain factors. However the cancer cells do not require the growth factors. Hence these cells do not respect usual cellular growth limits.

Normal cells have a nature of remaining together in tissues. But the cancer cells are less adhesive to each other. Hence they wander through the tissues and enter the blood. They can be transported to all parts of the body and cause new cancer growths.

The cancer cells rapidly multiply. Some cancers also produce angiogenic factors that cause many new blood vessels to grow into the cancer. Thus these cells will drain all the nutrients and normal cells get deprived of food. Ultimately the normal cells and tissues suffer nutritive death.

Management of cancer

The treatment or management of cancer depends on an accurate diagnosis. Diagnosis is made through **microscopic observations**(tissue biopsy), study of markers on the surface of cells, cytochemical methods, cytogenetics and various scanning and 'x' ray diagnostic methods.

In order to compare results and for communicating treatment programme among medical personnel **staging systems** are essential (Ex: stage1, stage2) staging defines tumours as either confined to the tissue of origin or having spread to local tissues and organs and finally as having metastasized.

After diagnosis, treatment of cancer involves surgery, chemotherapy, radiotherapy and hormonal treatments.

Till last century, surgery was the only effective method of treatment. Even to-day through surgery biopsy can be effected for diagnosis. If the tumour is restricted to the primary site, through surgery it can be removed. In latest treatment procedures surgery is restricted to affected region, rather than amputation or removal of the entire organ.

Radiotherapy :- Discovery of x-rays by Roentgen(1895) and of radioactivity by Curies in 1899 opened new ways of treating cancer. In Radiotherapy high energy ionising radiations are used. The radiations used are x-rays and gamma rays or subatomic particles such as beta particles, high energy electrons and neutrons or charged particles like helium ions. Ionising radiations can penetrate tissues. They can damage DNA leading to cell death and mutagenesis. The basis of radiation therapy depends on the differential sensitivity of the tumour tissue and the normal tissue. Hence the aim of radiotherapy is to prescribe sufficient radiation dose to the tumour, sparing as much of the normal tissue as possible.

Chemotherapy :- The purpose of chemotherapy is to prevent cancer cells from multiplying, invading and metastasizing. The chemicals used in treatment affect cell multiplication and tumour growth. Several drugs are now available for usage. They can be used singly or in combination. Some cancers like breast cancer are hormone dependent. Hence hormones are used in their management.

In spite of all advances in diagnostics and treatment, the death rate due to cancer is greater. Primary prevention of cancer will be a better alternative to diagnosis and treatment. 70% to 80% of cancers result from environmental causes. Hence public awareness towards environmental issues is a need. 33% of cancers in India are tobacco related. Hence smoking cessation and other measures to reduce tobacco usage are to be insisted upon. Consumption of fibrous food and avoidance of fatty food will avoid tumours related to alimentary canal.

Thus it is apparent that fight against cancer will be successful with early detection and appropriate education for avoidance.

Self Evaluation

Part I

Choose the correct answer

- Living cells which are wet cannot be viewed in a / an
 - Compound microscope
 - Phase - contrast microscope
 - Electron microscope
 - Dark - field microscope.
- The increase in size of optical image over the size of the object is known as
 - limit of resolution
 - transmission
 - power of magnification
 - conductance
- The name 'cell' was coined by
 - Leeuwenhoeck
 - Robert Brown
 - Robert Hook
 - Galileo
- In a microscope the light is focussed on the object through
 - condenser lens
 - objective lens
 - ocular lens
 - oil immersion lens
- A three dimensional image of the object can be produced using
 - compound microscope
 - dark-field microscope
 - transmission electron microscope
 - scanning electron microscope

6. In microscopy a nucleus is normally stained using
- (a) Neutral red (b) Janus green B
(c) Eosin (d) Hematoxylin
7. In cytological technique Bouin's solution is used for
- (a) fixation (b) dehydration
(c) cleaning (d) embedding
8. A unit membrane hypothesis for plasma membrane structure was provided by
- (a) Overton (b) Daveson
(c) Robertson (d) Nicholson
9. In the plasma membrane the lipid bilayer is covered by
- (a) proteins (b) carbohydrates
(c) water molecules (d) nucleic acid
10. The role of mitochondria in oxidative phosphorylation was explained by
- (a) Leninger (b) Embden
(c) Krebs (d) Meyer hoff
11. Which of the following is called as the cell respiratory organelle
- (a) ribosomes (b) lysosomes
(c) golgi bodies (d) mitochondria
12. The ribosomes are meant for
- (a) phosphorylation (b) respiration
(c) protein synthesis (d) oxidation
13. Which of the following organelle forms the intra cellular transporting system
- (a) mitochondria (b) lysosomes
(c) Endoplasmic reticulum (d) ribosomes
14. Which of the following cell may not contain golgi apparatus
- (a) epithelial cells (b) glandular cells
(c) RBC (d) secretory cells
15. The lysosome originates from
- (a) mitochondria (b) ribosomes
(c) nucleus (d) golgi apparatus
16. The movement of the flagellum is regulated by
- (a) plasma membrane (b) nucleus
(c) basal body (d) ribosomes

17. The number of nucleus (nucleii) in matured mammalian erythrocytes is
- (a) one (b) many
(c) two (d) nil

Part - II

Give very short answer

1. Write a note on phase contrast microscope.
2. What is 'limit of resolution' in the functioning of a microscope ?
3. Name the various parts of a compound microscope.
4. What are vital stains ?
5. Name two biochemical processes happening within the mitochondria.
6. What are RER and SER ?
7. What is 'autolysis' ?
8. When do we call centriole as a basal body.
9. What are the types of chromosomes based on the nature of their arm ?
10. What is a 'fluid mosaic model' of a plasma membrane ?

Part - III

1. Write notes on cell theory.
2. Explain the various units of measurement in cell biology .
3. Differentiate TEM and SEM.
4. Provide the structure of the golgi apparatus.
5. Write notes on the organisation of a centriole.

Part - IV

1. Give an account of types of microscopes.
2. Describe how a specimen is prepared for microscopic study.
3. Write an essay on structure and functioning of mitochondria.
4. Provide a detailed account on the organisation of cell nucleus.

3. Human Anatomy

3.1. History of Human anatomy

The term 'anatomy' is Greek in origin. It takes its root from 'ana' and 'tome' (ana-up ; tome-cutting). Thus anatomy is the science of physical structure of an animal or plant studied by dissection. The Human Anatomy provided the necessary knowledge for surgery and medicine.

The study of human anatomy dates back to 2500 BC, when the Egyptians prepared mummies. They removed internal organs of cadavers being mummified. They also did surgery for wounds and broken bones. In India during 500 - 491 BC Susruta performed cataract operation. In 1st century AD, Celsus, a Roman physician wrote about surgical procedures.

The year 1543 AD was significant due to publication of an accurate book on Anatomy by Andreas Vesalius. In 1628 William Harvey described the functioning of heart and the movement of blood in animals. These earlier works were followed by the discovery and accurate account of each and every organ system and organs in human body. In the recent times, attempts are being made to understand the molecular architecture in every cell of our body.

Gray's Anatomy

Eventhough several books had been written on Human Anatomy, a monumental work titled '*Anatomy : Descriptive and Surgical*' by **Henry Gray** is unique in its discriptions. The first edition of this book was published in August 1858. It is in print continually for the past 145 years. A more elaborate 38th edition was published in the year 2000.

Henry Gray was born in Windsor, London in 1827. He lived upto 1861. He was a brilliant medical student at St. George's Hospital, London.

3. 1. 1 The Integumentary System

The word integument means covering. The integumentary system covers the outside of the body. It protects internal structures, prevents the entry of infectious agents, reduces water loss, regulates body temperature, produces vitamin D and detects stimuli such as touch, pain and temperature. Since the integument performs several functions, it is commonly referred to as *Jack of all trades*.

The skin or integument rests on layers of cells called **hypodermis**. The hypodermis attaches the skin to underlying bones and muscles. It supplies blood vessels and nerves to the skin.

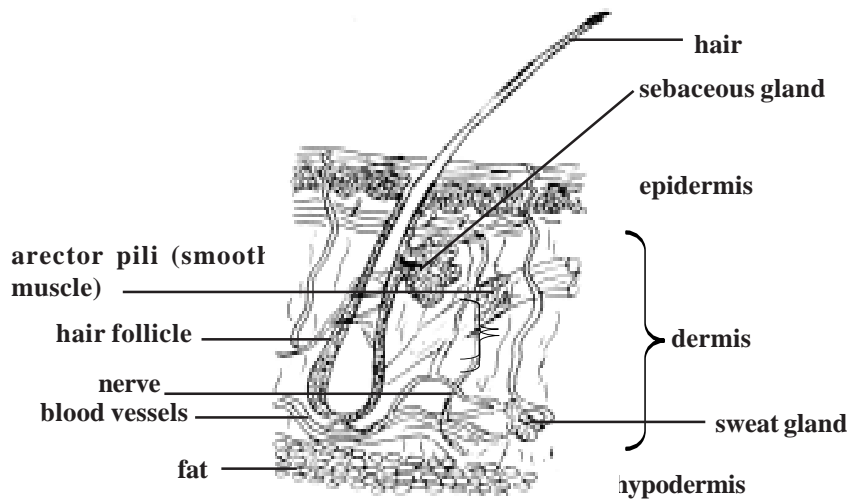

Fig.3.1.1. Skin and hypodermis

The skin is composed of two major tissues, namely **dermis** and **epidermis**. The dermis is mostly formed of connective tissue having fibroblasts, adipose cells and macrophages. It provides the structural strength to the skin. The dermis accommodates nerve endings, hair follicles, smooth muscles and glands.

It is divided into two layers, namely the superficial **papillary layer** and deeper **reticular layer**. The papillary layer has projections called papillae. The reticular layer is the major layer of the dermis. It is dense in nature. It is continuous with the hypodermis.

Epidermis :- The epidermis is made up of stratified squamous epithelium. It is separated from the dermis by a **basement membrane**. It contains mel-

anocytes giving colour to the skin. Many of the cells of the epidermis produce a protein substance called **keratin**. Hence they are called as **keratinocytes**.

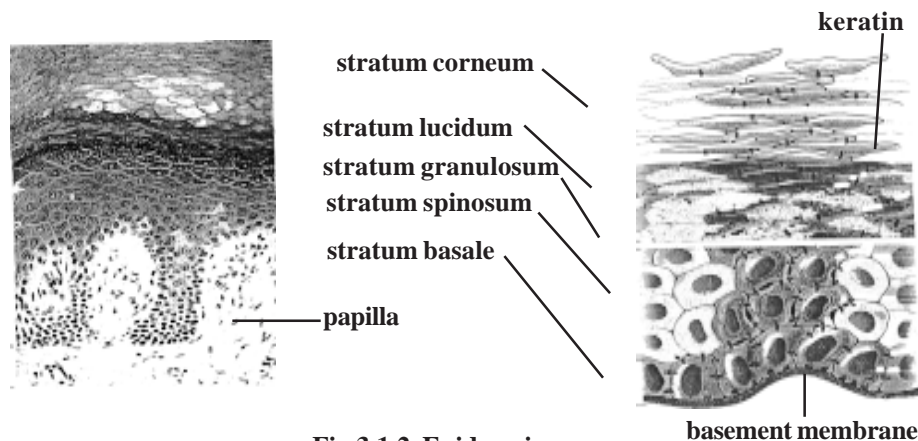

Fig.3.1.2. Epidermis

The deepest layers of the epidermis produce new cells by mitosis. As new cells are formed, the older cells are pushed to the surface. The surface cells will protect the inner new cells. Gradually the shape and chemical nature of the surface cells will get altered. Slowly they get filled with **keratin**. This process is called **keratinization**. During this process the epidermis gets divided into five distinct regions or **strata**. They are the **stratum basale**, **stratum spinosum**, **stratum granulosum**, **stratum lucidum** and **stratum corneum**.

Stratum basale is in the deeper region of the epidermis. It consists of one layer of columnar cells. Keratinization of cells begins in this region. Above this layer **stratum spinosum** is seen. It has 8-10 layers of polygonal cells. The **stratum granulosum** is the next upper layer. It has 3-5 layers of flattened cells. Above this layer **stratum lucidum** occurs. It is a thin zone having several layers of dead cells. The top most layer is called the **stratum corneum**. It consists of more than 20 layers of dead cells. These cells get filled with keratin. They are said to be **cornified**. The cornified cells are surrounded by a hard protective envelope.

The skin can be either **thick** or **thin**. All five epithelial layers are seen in the thick skin. However stratum corneum contains more number of cells. **Thick skin** is formed in the soles of the feet, the palms of hands and tips of fingers. The general body surface has **thin skin**. In the thin skin each epithelial layer in turn has few layers of cells. There are only one or two layers of cells in stratum granulosum.

Callus :- The regions of skin subjected to constant friction or pressure are thickened to form the **callus**. The callus has several layers of cells in the stratum corneum.

Skin colour :- The colour of the skin is due to pigments in the skin. The thickness of the stratum corneum and blood circulation can also cause skin colour. Normally the colour is caused by the pigment **melanin**. It provides colour to skin, hair and eye. It protects the body from sun's ultraviolet rays. Melanin is produced by melanocytes. Melanin production is genetically determined. However, hormones and exposure to light can also alter the colour.

Skin derivatives

Hair :- The hairs are integumentary structures. A hair has a root and a shaft. While the shaft projects above the skin, the root remains well below the surface. The base of the root has a **hair bulb**. It is an expanded region. The shaft and most of the root of the hair are formed of dead keratinized epithelial cells. These are arranged in three concentric layers called the **medulla**, the **cortex** and the **cuticle**. The central axis of the hair is formed of the **medulla**. Major part of the hair is formed of a single layer of cells.

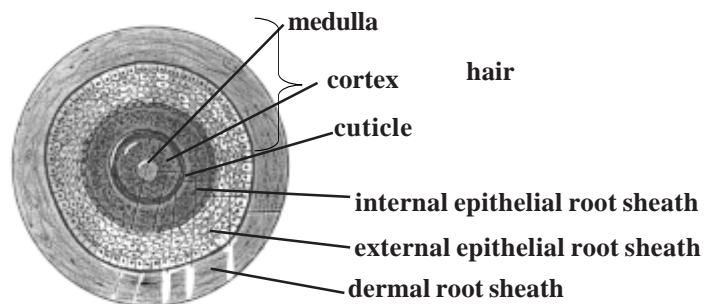

Fig.3.1.3. Cross section of a hair within a follicle

According to the amount and types of melanin, the hair colour may vary. The colour of the hair is genetically determined. During old age the amount of melanin decreases causing **white hair**. **Grey hair** has a mixture of faded, unfaded and white hairs.

The hair growth is due to addition of cells at the base of the hair root. The growth stops at specific stages. After a resting period, new hair replaces old hair. The hairs on the head grow for a period of three years and rest for 1-2 years.

The muscle cells found associated with hair follicles are called the **arrector pili**. Contraction of these muscles cause ‘goose flesh’ making the hairs to ‘stand on end’.

The skin has **sebaceous glands** and the **sweat glands**. The sebaceous glands are located in the dermis. They produce an oily substance called the **sebum**. These glands are connected by a duct to the upper part of the hair follicles. The **mammary glands** are the modified sweat glands.

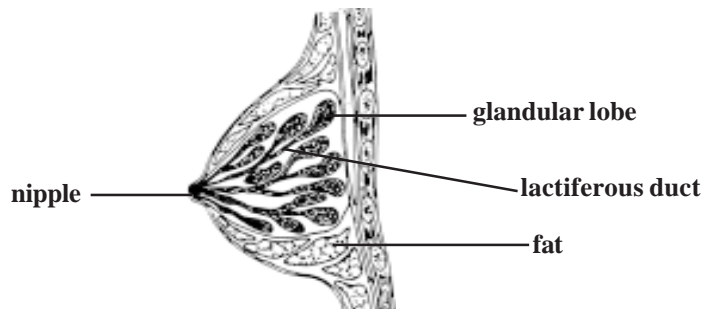

Fig.3.1.4. The mammary gland

The most common type of sweat gland on the skin are the **merocrine glands**. They are simple coiled tubular glands. They open directly on to the skin through sweat pores. The gland has two parts. They are the deep coiled portion and the duct which passes to the surface of the skin. The number of sweat glands are more in the palms of the hands and soles of the feet.

Nails :- Each nail is made up of two parts. They are the **nail root** and the **nail body**. The nail body is the visible part. The nail root is covered by the skin. The proximal and lateral edges of the nail are covered by nail fold.

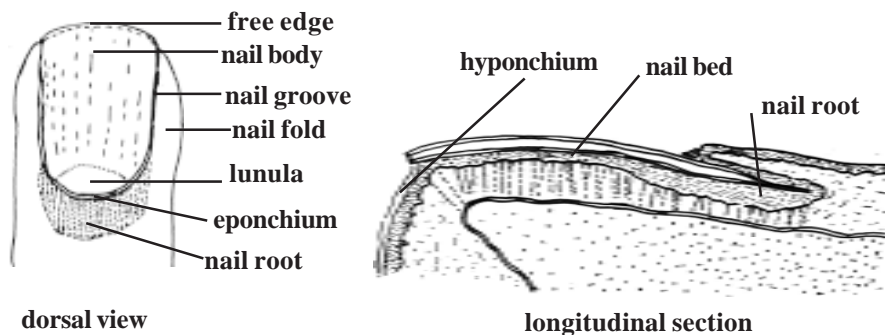

Fig.3.1.5. Nail

The stratum corneum of the nail fold grows onto the nail body as the **eponychium**. The free edge of the nail body is the **hyponychium**. The nail is found placed on the nail matrix and nail bed. A small white region seen at the base of the nail is the **lunula**. It contains the nail matrix. The nails grow at an average rate of 0.5-1.2 mm per day.

3.2. Skeletal system

The skeletal system is constituted by bones, cartilages and ligaments. This system provides 'the shape' to the body. Further, bones remain as regions for the attachment of muscles. It also helps to hold weight. Structures like skull, protect inner organs. This system is also useful in locomotion. The bones remain as reservoirs of fat and certain minerals. The bone marrow is the site for the production of erythrocytes.

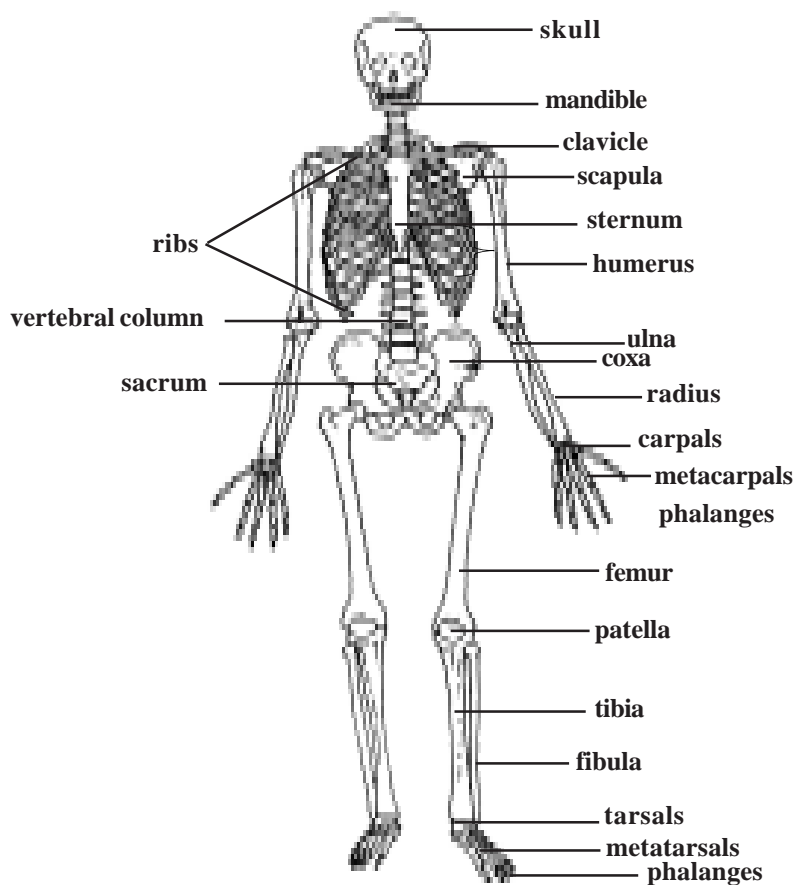

Fig.3.2.1. The complete skeleton

The bones can be long, short, flat or irregular in shape. Hands and legs have **long bones**. **Short bones** are broad in shape. Carpals (wrist bones) and tarsals (ankle bones) are shorter. **Flat bones** are thin and flattened. Skull bones, ribs, sternum and scapula (shoulder blade) are **flat bones**. Vertebral and facial bones are **irregular** in shape.

Structure of a typical long bone

A bone is covered by a double layered sheath called the **periosteum**. The outer layer of the periosteum is fibrous in nature. It is a dense collagenous layer having blood vessels and nerves.

A growing long bone has three regions. The long bony part is the **diaphysis** or **shaft**. It is made up of compact bone.

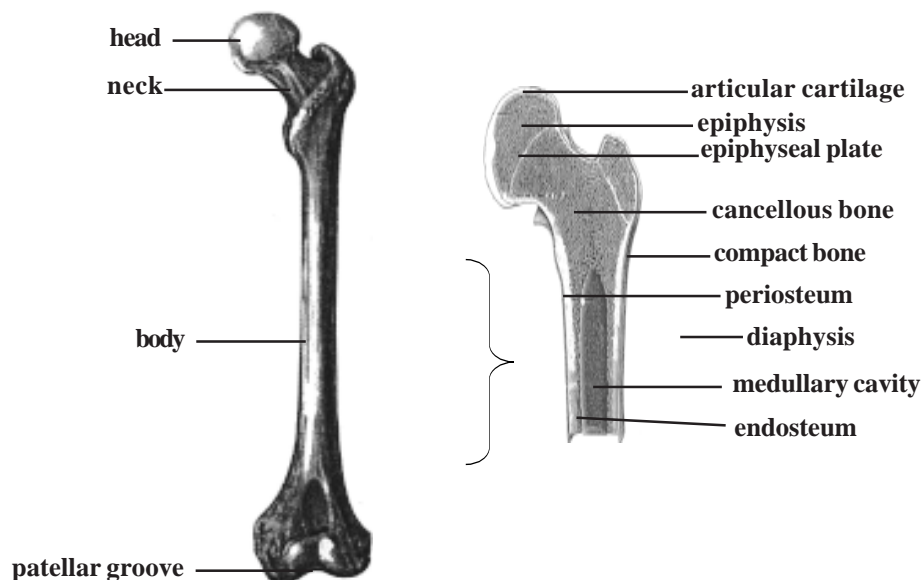

Fig.3.2.2. Long bone - Femur or thigh bone

The end of the bone consists of **epiphysis**. It is made up of spongy bone. The outer surface of epiphysis is formed of compact bone. In between the epiphysis and diaphysis **epiphyseal** or **growth plate** is found. It is made up of hyaline cartilage. Growth in length of bone occurs at this plate.

The cavity inside the diaphysis is called the **medullary cavity**. This cavity is lined by a membrane called the **endosteum**. The cavity inside the diaphysis in adults contain **yellow marrow**. It is mostly adipose tissue. The medullary cavity of the epiphysis contains **red marrow** concerned with blood cell formation.

Dried, prepared bones are used to study skeletal anatomy. The bones are named according to their position in the body. The named bones are divided into two categories: (1) **the axial skeleton** and (2) **the appendicular skeleton**. The axial skeleton consists of the skull, hyoid bone, vertebral column and thoracic cage. The appendicular skeleton consists of the limbs and their girdles. In human body, there are **206** bones, of these **80** are in the **axial skeleton**, **126** in the **appendicular skeleton**. Among the bones of the axial skeleton **28** bones are in the **skull**, **26** bones in the **vertebral column**, **25** bones in the **thoracic cage** and one remains as the **hyoid bone**. (details as found below)

Axial skeleton - It forms the upright axis of the body. It protects the brain, the spinal cord and the vital organs found within the thorax.

a) **Skull** - The human cranial capacity is about 1500 cm^3 . It consists of 22 bones. It protects the brain. It supports the organs of vision, hearing, smell and taste. The **lower jaw** or **mandible** remains specially attached to the skull. The skull or cranium is covered by eight bones. They are one pair each of **parietal** and **temporal**, individual bones as **frontal**, **sphenoid**, **occipital** and **ethmoid**. These bones are joined by sutures to form a compact box like structure. **The sutures** are immovable

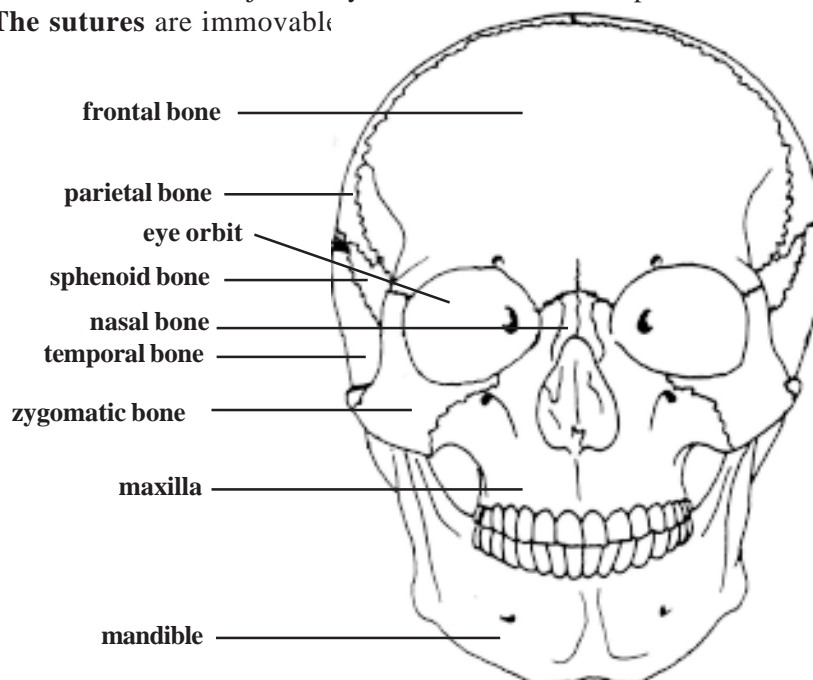

Fig.3.2.3. Skull

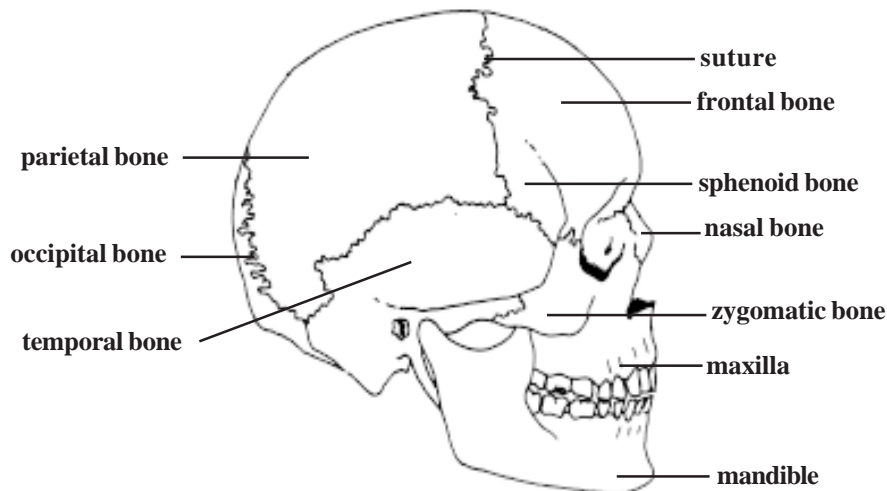

Fig.3.2.4. Skull - Lateral view

In the front there are 14 facial bones. Of these **maxilla, zygomatic, palatine, lacrymal, nasal** and **inferior nasal koncha** remain as pairs. **Mandible** or **lower jaw** and **vomer** are unpaired bones .

The **parietal** and **occipital** bones are major bones on the posterior side of the skull. The parietal bones are joined to the occipital bone at the back. The side of the head is formed of the parietal and the **temporal** bones. The large hole in the temporal bone is the **external auditory meatus**. This opening is meant for transmitting sound waves towards the eardrum. On the lateral side immediately anterior to the temporal, the **sphenoid** bone is seen. Anterior to the sphenoid bone is the **zygomatic bone** or **cheek bone**. It is a prominent bone on the face. The upper jaw is formed of the **maxilla**. The **mandible** constitutes the lower jaw.

The major bones seen from the frontal view are the **frontal bone, zygomatic bone** the **maxillae** and the **mandible**. The most prominent openings in the skull are the **orbits** and the **nasal cavity**. The two orbits are meant for accommodating the eyes. The bones of the orbits provide protection for the eyes and attachment points for the muscles that move the eyes. The bones forming the oribits are the **frontal, sphenoid, zygomatic, maxilla, lacrymal, ethmoid** and **palatine**. The head region also contains 6 ear ossicles. They are Maleus (2), incus (2) and stapes (2).

A large opening found at the base of the skull is the **foramen magnum**. Through this opening the medulla oblongata of the brain descends down as the spinal cord.

b). **Vertebrae** - The vertebrae make up the slightly S-shaped **vertebral column** or **backbone**. The vertebral column consists of 26 bones. They are divided into 5 regions. They are the **cervical** (7), **thoracic** (12), **lumbar** (5), **sacral** (1) and **coccygeal** (1) vertebrae.

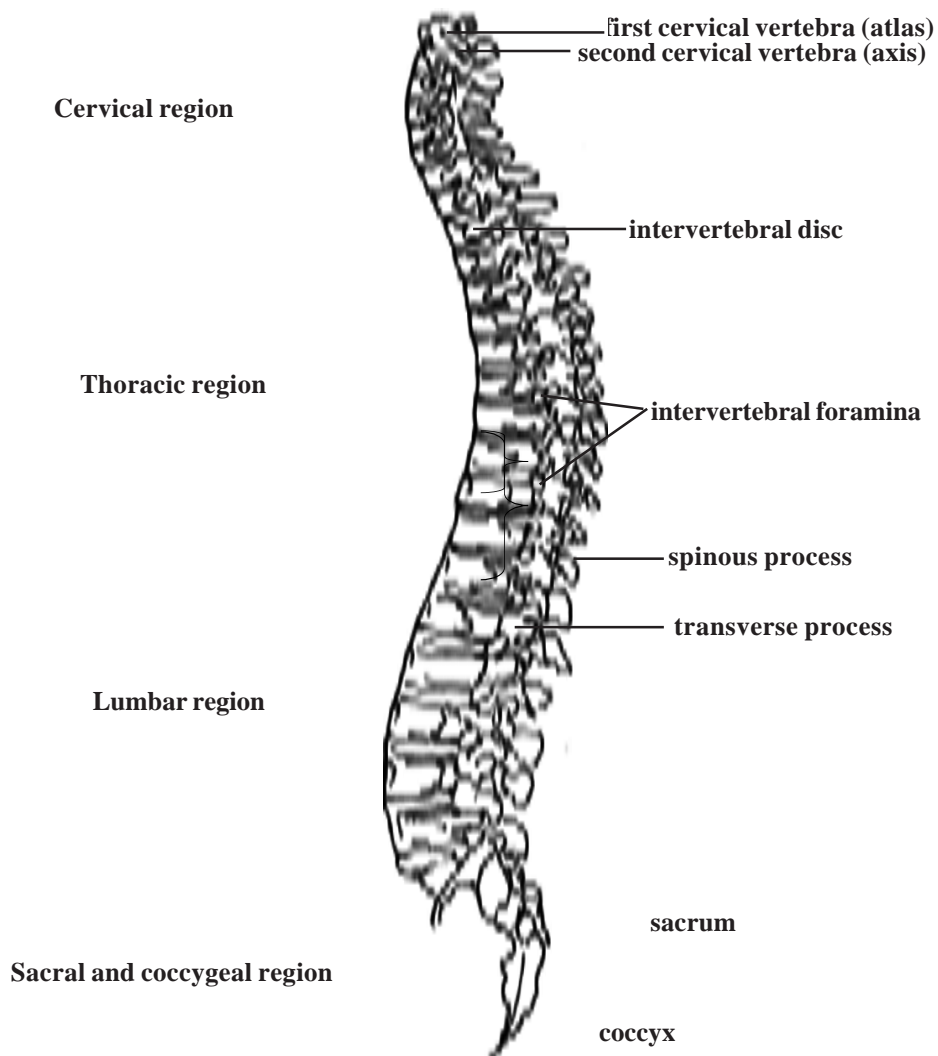

Fig.3.2.5. Vertebral column

Vertebra - Structure : The main load - bearing portion of a vertebra is a solid disc of bone called the **centrum**. The centra of adjacent vertebrae are separated by intervertebral discs of cartilage. Projecting from the centrum dorsally is a **vertebral arch**. It encloses the neural canal. This canal contains the spinal cord. Several bony projections are seen on the vertebral arch. On each side of the centrum there are two **transverse processes**. On the dorsal side there is a **neural spine**. These bony projections are used for attachment of muscles. Further, there are two superior and two inferior processes meant for articulation with the neighbouring vertebra.

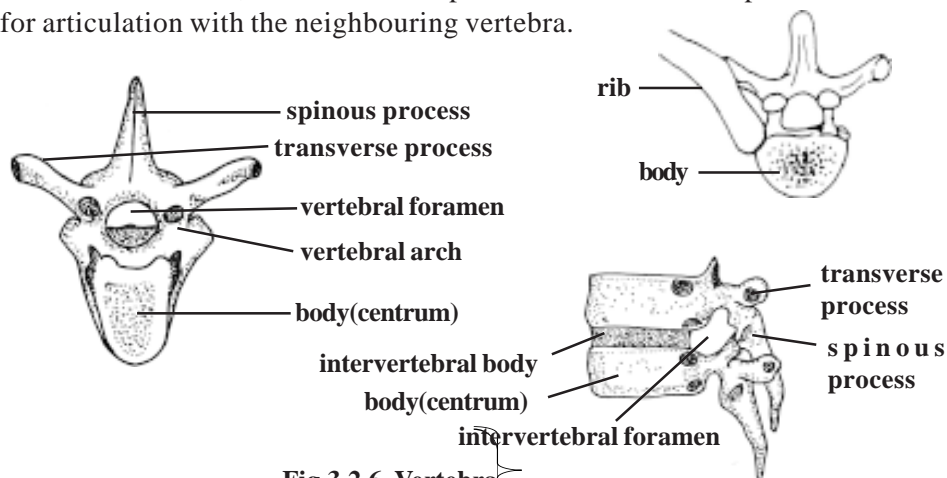

Fig.3.2.6. Vertebra

The first **cervical** vertebra is the **atlas**. It balances and supports the head. It has no centrum. The second is the **axis**. The **sacral** vertebrae are fused. They form a triangular structure called the **sacrum**. The coccygeal vertebra has no function. It is a vestige. During development in the embryonic stage there are nearly 34 vertebrae present. Of these, 5 sacral bones are fused to form a single **sacral bone**. 4 or 5 coccygeal bones are fused to form a single **coccyx**.

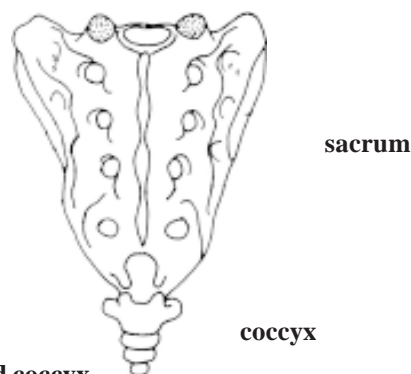

Fig.3.2.7. Sacrum and coccyx

c). **Rib cage** - There are 12 pairs of ribs. Each articulates with a thoracic vertebra. In the front, the first ten pairs are attached to the sternum (breast bone) by costal cartilages. The first seven are attached directly to the sternum. They are called the **true ribs**. Cartilages of 8th, 9th and 10th ribs are fused and attached to 7th. They are called the **false ribs**. 11th 12th pairs are not attached to the sternum. They are called **floating ribs**.

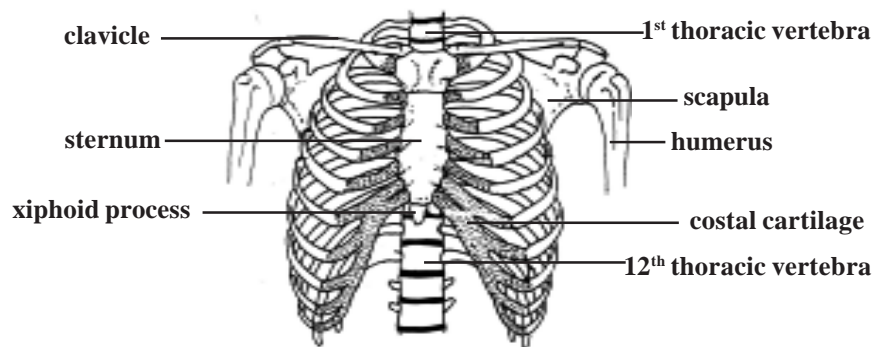

Fig.3.2.8. Rib cage

Appendicular skeleton

It consists of the bones of the **upper** and **lower limbs** and the **girdles** by which they are attached to the body.

Pectoral girdle - The hands are attached to the pectoral girdle. Both of them are attached loosely by muscles to the body. This arrangement facilitates freedom of movement. Hence it is possible to place the hand in a wide range of positions.

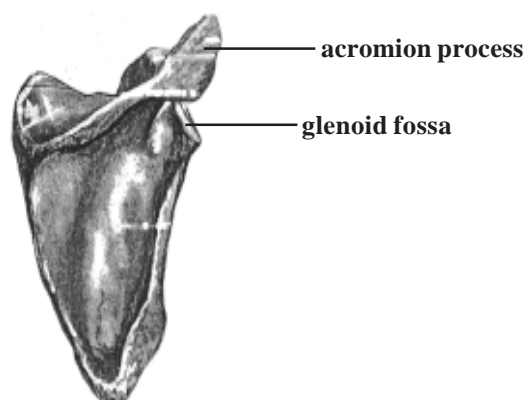

Fig.3.2.9. Scapula

The pectoral or shoulder girdle consists of two pairs of bones. Each pair has a **scapula** or shoulder blade and a **clavicle** or collarbone. The **scapula** is a flat, triangular bone. A **glenoid fossa** is located in the superior lateral region of the scapula. It articulates with the head of the humerus. The **clavicle** is a long bone. It has a slight S-shaped curve. It can be easily seen and felt. The clavicle holds the upper limb away from the body.

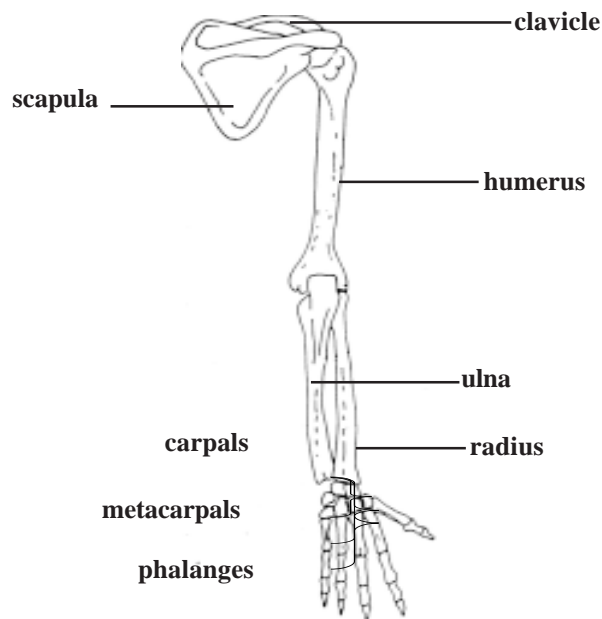

Fig.3.2.10. Skeleton of the arm

Pelvic girdle or pelvis - It is a ring of bones formed by the sacrum and paired bones called the **coxae** or **hip bones**.

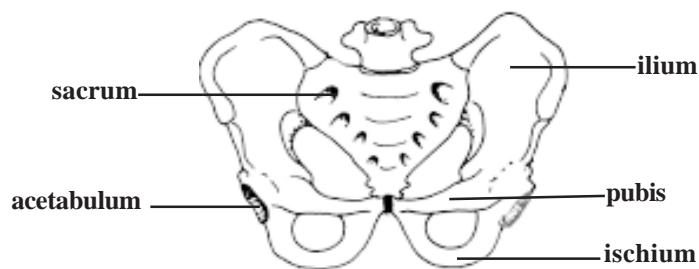

Fig.3.2.11. Pelvis

Each coxa is formed by the fusion of three bones, namely **ilium**, **ischium** and **pubis**. A fossa called the **acetabulum** is located on the lateral surface of each coxa. The acetabulum is meant for the articulation of the lower limbs.

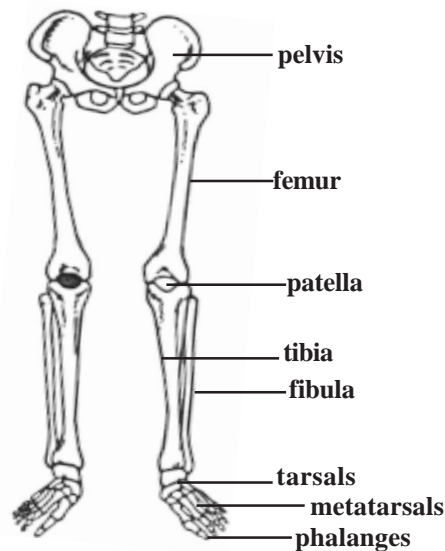

Fig.3.2.12. Skeleton of the leg with pelvic girdle

Upper limb or hand - The part of the upper limb from shoulder to the elbow is the **arm**. It contains one long bone called the **humerus**. The **head** of humerus articulates with the **glenoid fossa** of the scapula. The distal end of the bone articulates with the two forearm bones.



Fig.3.2.13. Femur

Forearm - This part of the hand is in between the arm and the wrist. The forearm has two bones. They are the **ulna** and the **radius**. While the ulna is on the side of the little finger, the radius is on the lateral or thumb side of the forearm.

Wrist - This short region is composed of eight **carpal bones**. These are arranged into two rows of four each. The carpals along with accompanying ligaments are arranged in such a way that a tunnel on the anterior surface of the wrist called the **carpal tunnel** has been formed. Tendons, nerves and blood vessels pass through this tunnel to enter the hand.

Hand - The bony framework of the hand is formed of five **metacarpals**. They are attached to the carpals in the wrist. The concave nature of the palm in the resting position is due to curved arrangement of metacarpals.

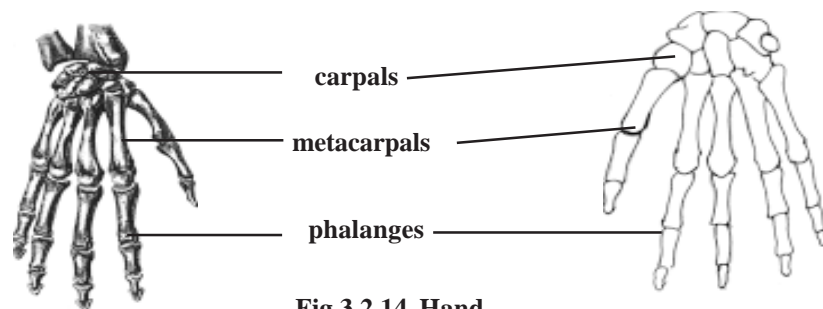

Fig.3.2.14. Hand

Each hand has five digits. They include one thumb and four fingers. Each digit has small long bones called **phalanges**. While the thumb has two phalanges other fingers have three each.

Lower limb or Leg : The general pattern of the lower limb is similar to that of the upper limb.

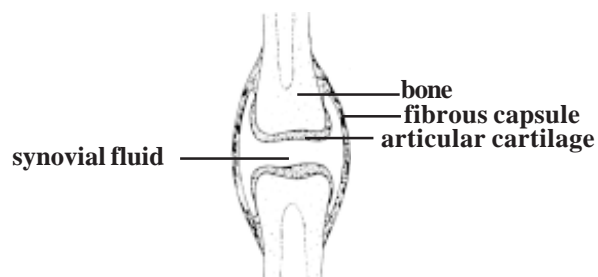

Fig.3.2.15. A Synovial joint

The upper region of the leg is the thigh. It contains a single longest bone called the **femur**. It has a prominent rounded **head** for articulating with the acetabulum of the pelvic girdle. The distal end of the femur has two condyles for articulation with the **tibia**.

The knee region has a large, flat bone called the **patella**. It articulates with the patellar groove of the femur.

Leg - The leg is that part of the lower limb between the knee and the ankle. It consists of two bones namely, the **tibia** and the **fibula**. The tibia is larger and it supports most of the weight of the leg.

Ankle : The ankle consists of seven **tarsal bones**. The ankle articulates with the tibia and the fibula through the **talus**.

Foot : It is formed of metatarsals and phalanges. They correspond to the metacarpals and phalanges of the hand.

Joint

All bodily movements are caused by muscles. Our skeletal muscles are firmly attached to bones. Movements involving such muscles cause pull on our bones. Hence movements need movable bone joints.

A joint or an articulation is a place where two bones come together. All joints are not movable. Many joints allow only limited movements.

The joints are named according to the bones that are united.

Kinds of joints - There are three major kinds of joints. They are the **fibrous**, **cartilaginous** and **synovial joints**.

Fibrous joints - In this type, the joints are united by fibrous connective tissue. There is no joint cavity. These joints show little or no movement. **Sutures** formed between cranial bones, a **syndesmosis** (to bind) between radius and ulna are examples for this type.

Cartilaginous joints - These joints unite two bones by means of either hyaline cartilage (**synchondroses**) or fibrocartilage (**symphyses**). The articulation between the first rib and the sternum is an example for **synchondrosis**. **Symphysis pubis** and **intervertebral discs** are examples for **symphyses**.

Synovial joints - These joints contain a **synovial fluid**. This fluid is a complex mixture of polysaccharides, proteins, fats and cells. It forms a thin lubricating film covering the surfaces of a joint. Elbow and knee joints are of this type.

3.3. Muscular System

Locomotion and bodily movements are characteristic features of the animals. The movements are effected by various cell organelles such as cilia, flagella and organs like muscles. Muscular movements are more powerful and energetic. The skeletal muscles apart from their role in smarter movements, provide beautiful shapes to the body. The inner smooth muscles of the visceral organs make them work like machines all through the life period. The muscle cells function like small motors to produce the forces responsible for the movement of the arms, legs, heart and other part of the body. Thus the highly specialized muscle tissues are responsible for the mechanical processes in the body.

Based on structure, functioning and occurrence three different types of muscle tissues have been identified. They are the **skeletal**, **visceral** and **cardiac** muscles.

- 1). **Skeletal muscles or striped muscles** : These muscles are attached to the bones. The muscle cells are long and cylindrical. These voluntary muscles cause body movements.
- 2). **Visceral muscles or Nonstriated muscles**: These are found in the walls of the inner organs such as blood vessels, stomach and intestine. The muscle cells are spindle shaped. These are involuntary in nature.
- 3). **Cardiac muscle** : These are found in the wall of the heart. The muscle cells are cylindrical and branched. The muscles are involuntary in nature.

Skeletal muscles.

The skeletal muscles are attached to bones by **tendons**. The tendons help to transfer the forces developed by skeletal muscles to the bones. These muscles are covered by sheets of connective tissue called **fascia**.

Tendons : These are connective tissue structures showing slight elasticity. They are like cords or straps strongly attached to bones. The tensile strength of tendons is nearly half that of steel. A tendon having 10 mm diameter can support 600 - 1000 kg.

Fascia : These are assemblages of connective tissues lining skeletal muscles as membranous sheets. The fascia may be superficial or deep. The superficial fascia is a layer of loose connective tissue found in between skin and muscles. The deep fascia are collagen fibres found as a tough inelastic sheath around the musculature. They run between groups of muscles and connect with the bones.

Shapes of muscles.

There is a wide variety of shapes and sizes in muscles. Based on general shape and the orientation of muscle fibres in relation to the direction of pull, they can be grouped into two classes.

1. **Parallel** : These muscle fibres are parallel to the line of pull. The muscles may be flat, short, quadrilateral or long and strap like. The individual fibres run the entire length of the muscle.

2. **Oblique** : These muscle fibres are oblique to the line of pull. The muscles may be triangular or pennate (feather-like). The pennate forms may be unipennate, bipennate, multipennate or circumpennate. Some muscles have a spiral or twisted arrangement.

Naming of muscles.

The muscles are named according to their size, shape, position and action.

Shape

deltoid - triangular
quadratus - square
gracilis - slender

Size

major - large
minor - small
longus - long
lattismus - broadest

Number of Heads

biceps - 2 heads
triceps - 3 heads
quadriceps - 4 heads

Position

dorsi - of the back
pectoralis - of the chest
brachii - of the arm
anterior, posterior.

Depth

superficialis - superficial
internus - internal, flexor
profundus - deep

Action

extensor
constrictor
Flexor

Distribution of muscles

I. Muscles of the head

There are two groups of muscles. They are **craniofacial** and **masticatory** muscles. The craniofacial muscles are related to eye orbital margins, eyelids, nose, nostrils, lips, cheeks, mouth, pinna, and the scalp. These muscles are also known as **muscles of facial expression**. Among these muscles those that are related to the lip movement are significant. The facial expression is mostly due to lip movement and positioning of the lips. Such thought related movements are caused by several muscles associated with lips and the skin around the mouth. Since **orbicularis oris** and **buccinator** muscles provide lip movement for kissing posture they are known as “kissing muscles”. Smiling is accomplished by **zygomaticus major** and **minor**, **levator anguli oris** and **risorius**. The muscles of the lips can also provide expressions such as sneering and frowning. The chin dimples are located between the **mentalis** muscles

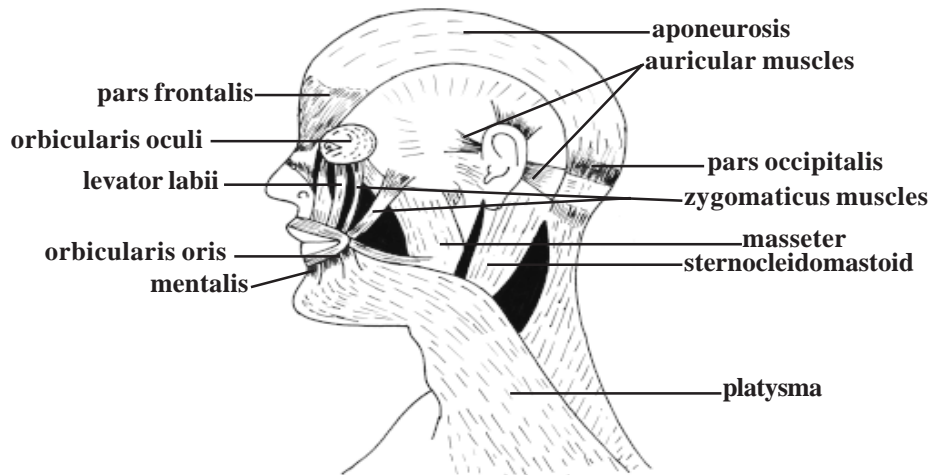

Fig.3.3.1. Muscles of the Head

The **masticatory** (or **speech**) **muscles** move the mandible of the lower jaw. The muscles responsible for this movement are **masseter temporalis** and **pterygoid**. Tongue movements are caused by **intrinsic** and **extrinsic** muscles. Swallowing of food is facilitated by several muscles related to the mouth, roof of pharynx, uvula and other regions.

II. Muscles of the Neck region.

The movements of the neck region are caused by **cervical**, **suprahyoid**, **infrahyoid** and **vertebral** muscles.

III. Muscles of the Trunk region.

The muscles of the vertebral column help to bend and rotate the body. These are strong back muscles that help the trunk to maintain erect posture. The most prominent muscles of this region are the **erector spinae**, **longissimus** and **spinalis**.

Four important thoracic muscle groups are associated with the process of breathing. While the process of inspiration is due to **scalene** and **external intercostal muscles**, the expiration is performed due to **internal intercostals** and transverse **thoracis**. Major breathing movement is due to **diaphragm**, a curved musculofibrous sheet that separates thoracic and abdominal cavities.

Abdominal muscles can aid in forced expiration, vomiting, defaecation, urination and childbirth.

The inferior opening of the pelvic bone is covered by **pelvic diaphragm** muscles. Below these muscles **perineum** is present. The perineum and other “subfloor” muscles form the **urogenital diaphragm**. Pelvic and urogenital diaphragm may get stretched in pregnancy due to weight of the foetus. However by specific exercises they can be strengthened.

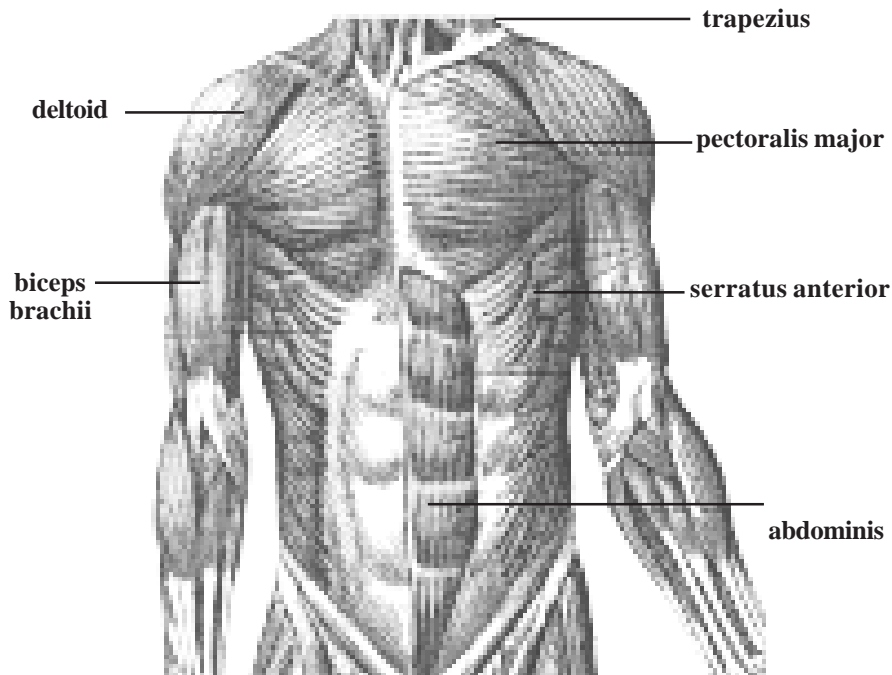

Fig.3.3.2. Muscles of the Trunk

IV. Muscles of the upper limb.

The hands are attached to the pectoral girdle and to the vertebral column by large conspicuous muscles such as **trapezius**, **rhomboid major** and **minor**, **levator scapulae** and **lattissimus dorsi**.

The **trapezius** is a flat, triangular muscle. It extends over the back of the neck and upper thorax. It maintains the level and poise of the shoulder. It helps to rotate the scapula forward, so that the arm can be raised above the head. It helps to bend the neck backwards and laterally.

Lattissimus dorsi is a large flat triangular muscle. It is a conspicuous muscle stretching over the lumbar region and lower thorax. This muscle is useful in adduction, extension and medial rotation of the humerus. It helps in the backward swinging of the arm. By raising the arm above the head it helps to pull the trunk upwards and forwards. It is useful in violent expiratory activities such as coughing or sneezing. It helps in deep inspiration.

Serratus anterior and **pectoralis major** connect the ribs to the scapula. **Pectoralis major** extends from the upper thorax and abdomen to act on the humerus. It is a fan shaped muscle. It spreads between the clavicle and the 7th costal cartilage in the front of the chest. It helps to swing the extended arm forward and medially. It helps in climbing. It is active in deep inspiration.

The muscles of the upper arm are the **coracobrachialis**, **biceps**, **triceps** and **brachialis**. The coracobrachialis arises from the coracoid bone in the shoulder and ends in the humerus of the upper arm. It helps to move the arm forward and medially. The **biceps brachii** is a large fusiform muscle. It has two proximal heads for attachment. They are connected to the coracoid and shoulder joint. The lower head ends in the radius of the lower arm. It is a powerful muscle causing flexing of the hand. The **triceps** arises by three heads from scapula and upper part of humerus on the posterior side. The wrist, hand and finger movements are caused by several extrinsic and intrinsic hand muscles. A detailed study of them could be made in higher classes.

V. Muscles of the lower limb.

Thigh movements are caused by anterior, posterolateral and deep muscles. The anterior muscles are the **iliacus** and **psoas major** which help to flex the thigh. The **gluteus maximus** form the mass of the buttocks region. Leg movement is caused by the anterior thigh muscles, **quadriceps femoris** and **sartorius**. The sartorius is the longest muscle of the body. It runs from the hip to the knee. Muscle movement of ankle foot and toe are caused by several groups of extrinsic and intrinsic muscles. A detailed study of them could be made in higher classes.

3. 4. Digestive system

The process of nutrition in man is holozoic. In this type of nutrition, the nutrients are made available to the body through digestion of food. In digestion, the macromolecules or biopolymers of food are hydrolysed to yield their corresponding monomers. This process is facilitated by enzymes. Thus the digestive system comprises the alimentary canal, associated glands and regions of absorption of food. The digestive tract comprises various organs from mouth to anus.

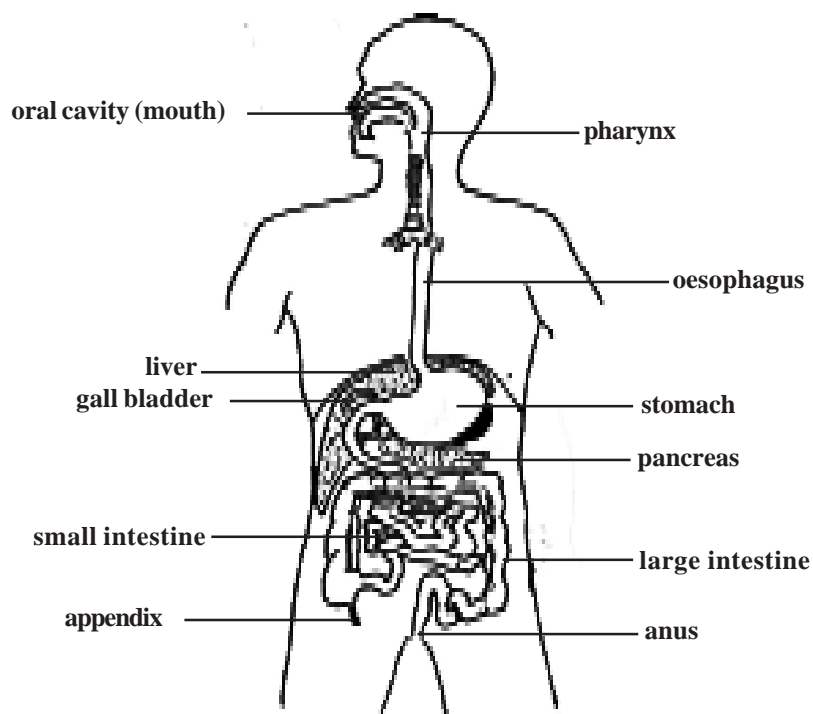

Fig.3.4.1. Digestive system

Mouth or Buccal cavity

The opening of the oral cavity is bounded by the lips. The lips are muscular folds covered internally by mucosa. The lateral walls of the oral cavity are the cheeks. The inner walls of the cheeks are lined by moist stratified squamous epithelium. The lips and cheeks are useful in the process of mastication and speech.

Tongue - It is a large muscular organ. It is attached to the floor of the oral cavity. The anterior part of the tongue is free. A thin fold of tissue called the **frenulum** attaches the free end to the floor of the mouth. The tongue is divided into two parts by a groove called the **terminal sulcus**. About two thirds of the anterior surface is covered by papillae. Some of them contain taste buds.

Teeth - There are 32 teeth in the mouth of a human adult. These are called as **permanent teeth**. There are 4 different types of permanent teeth seen. This nature is known as heterodontism. The types of teeth are **incisors**(8), **canines**(4), **premolars**(8) and **molars**(12). Since the teeth in the right and left side of the mouth are mirror images of each other, the dental arrangement is represented as follows.

i 2/2 : c 1/1 : pm 2/2 m 3/3 X 2 or

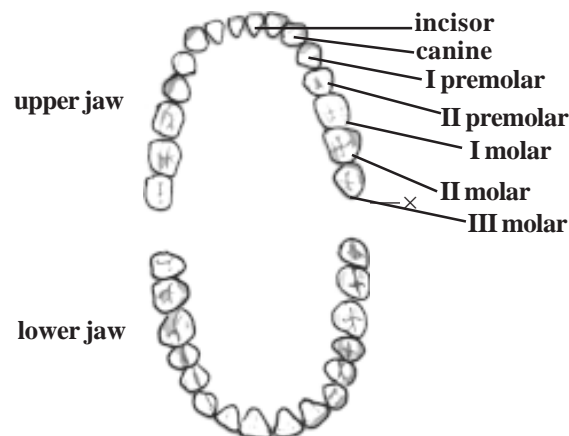

Fig.3.4.2. Dentition

Each tooth consists of three regions. These are the upper **crown**, middle **neck** and basal **root** regions. The crown region has one or more **cusps**. The tooth is made up of a calcified tissue called **dentine**.

The dentine of the tooth crown is covered by an extremely hard substance called **enamel**. The surface of the dentine in the root is covered with a bonelike substance called **cementum**. It helps to anchor the tooth in the jaw. In the centre of the tooth there is a **pulp cavity**. This cavity is also called as the **root canal**. This canal contains blood vessels and nerves. The canal opens at the base through **apical foramen**.

The teeth are set in sockets along the edges of the upper and lower jaws. This region of the jaw is covered by dense fibrous connective tissue and stratified squamous epithelium. It is called as the **gingiva**.

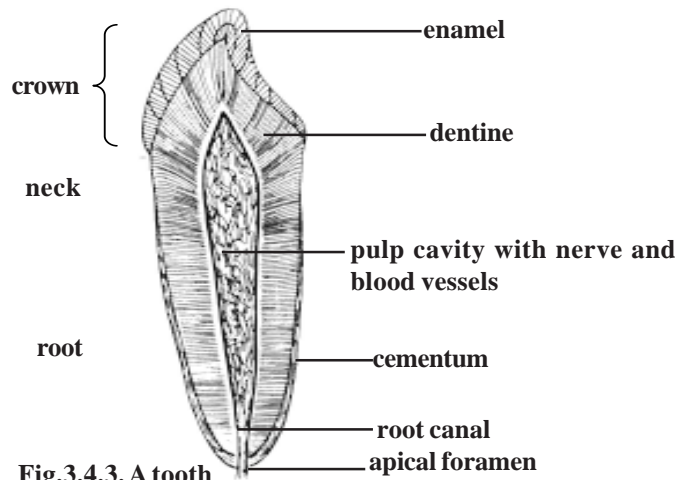

Fig.3.4.3. A tooth

Salivary glands : These are scattered throughout the oral cavity. Three pairs of glands are larger. They are the **parotid, submandibular** and **sublingual glands**. The **Parotid glands** are the largest. They are located just anterior to

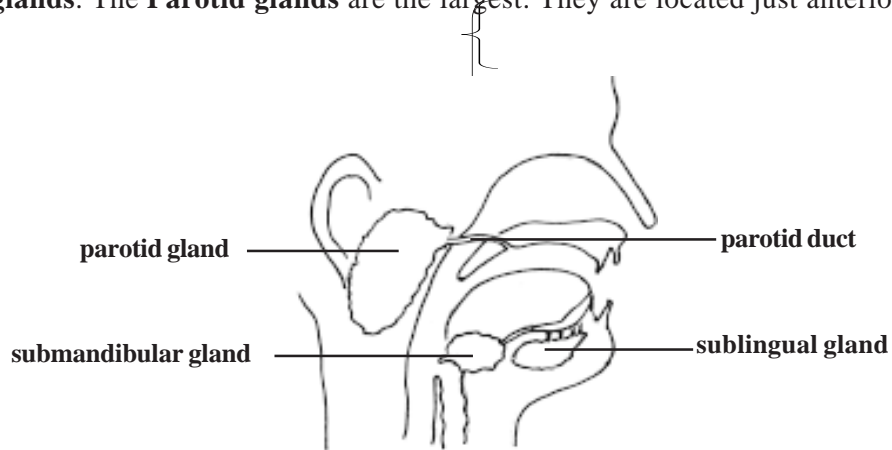

Fig.3.4.4. Salivary glands

the ear on each side of the head. The **submandibular glands** are found on the inferior borders of the mandible. The **sublingual glands** are the smallest. They lie immediately below the mucous membrane in the floor of the mouth. There are other numerous small, coiled, tubular glands in the mouth. They are the lingual (tongue), palatine (palate), buccal and labial (lips) glands.

Pharynx : A description of pharynx is provided under respiratory system.

Oesophagus : This part of the digestive tube extends between the pharynx and the stomach. It is about 25 cm long. It lies in the mediastinum of the thorax, anterior to the vertebra and posterior to the trachea. It passes through the diaphragm and ends at the stomach. The oesophagus has thick walls. The inner wall is lined by a moist stratified squamous epithelium. The upper and lower ends of this tube have **sphincters** to regulate the movements of materials.

Stomach : It is an enlarged sac like structure. This sac found in the upper part of the abdomen is horizontally placed. It is divisible into two regions namely **cardiac** and **pyloric** stomachs. The cardiac stomach is towards the left of the abdomen. The oesophagus opens into the cardiac stomach through the **gastroesophageal** or **cardiac opening**. A part of the stomach to the left of the cardiac region is the **fundus**. The largest part of the stomach is the **body**. The body narrows to form the **pyloric region**. The pyloric opening between the pylorus and intestine is surrounded by a ring of muscles called the **pyloric sphincter**.

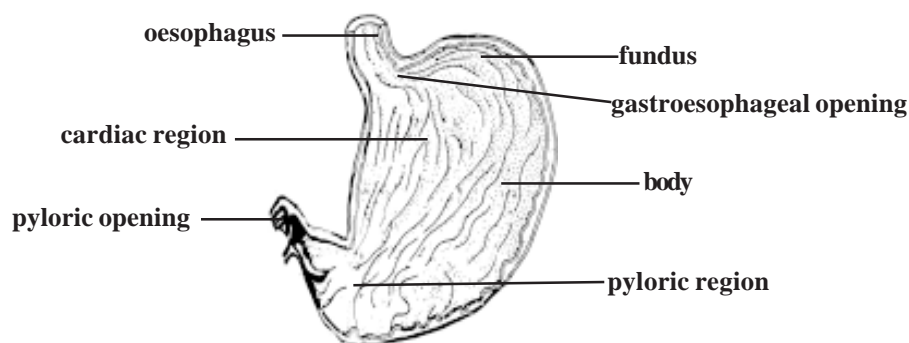

Fig.3.4.5. Section of the stomach

Small intestine : It consists of three parts: the **duodenum**, the **jejunum** and the **ileum**. The entire small intestine is about 6m. long.

Duodenum - It is about 25 cm. long. It curves within the abdominal cavity and completes nearly 180 degree arc. **Liver** and **pancreas** are associated with the duodenum.

Jejunum and ileum- The jejunum and ileum are 2.5m. and 3.5m in length respectively. These two are similar in structure to the duodenum. However

there is a gradual decrease in the diameter of the small intestine. The junction between the ileum and the large intestine is the **ileocaecal junction**. It has a ring of smooth muscles forming a sphincter, and a one way **ileocaecal valve**.

Liver : It is the largest visceral organ. It weighs about 1.36 Kg. The liver consists of two major **left** and **right lobes**, and two minor lobes **caudate** and **quadrate**. The bile secreted by the liver gets collected in the **gall bladder**. There are two hepatic ducts and they unite to form a single duct. The **common hepatic duct** is joined by the cystic duct from the gall bladder to form the **common bile duct**. It empties into the duodenum.

Gall bladder : It is a sac like structure on the inferior surface of the liver. It is about 8 cm long and 4 cm wide.

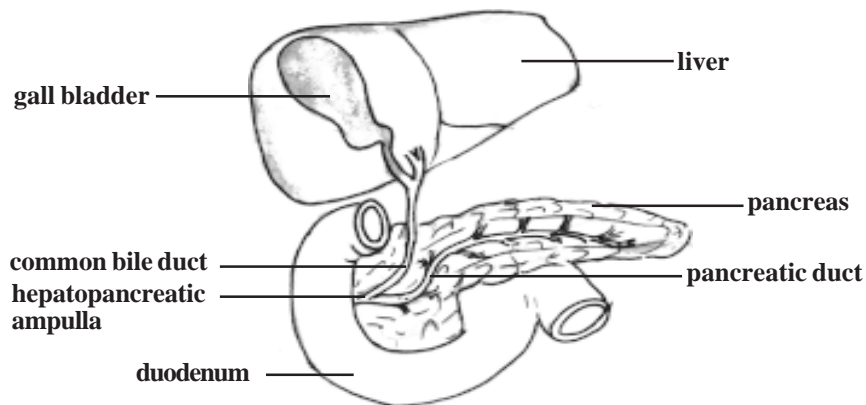

Fig.3.4.6. Duodenal region

Pancreas : It is a complex organ. It is composed of both endocrine and exocrine tissues. The endocrine part of the pancreas consists of **pancreatic islets**. They produce insulin and glucagon. The exocrine part of the pancreas consists of **acini**. They produce digestive enzymes. The pancreas consists of several lobules. The ducts from the **lobules** unite to form the **pancreatic duct**. It joins the common bile duct at the **hepatopancreatic ampulla**.

Large intestine.

Caecum : It is the proximal end of the large intestine. At this region large, and small intestines meet. The caecum is about 6 cm in length. Attached to the caecum is a small blind tube about 9 cm long. It is called the **vermiform appendix**.

Colon : It is about 1.5 - 1.8 m long. It consists of four parts namely the **ascending colon, transverse colon, descending colon** and **sigmoid colon**. The sigmoid colon extends into the pelvis and ends at the rectum.

Rectum : It is a straight, muscular tube that extends from the sigmoid colon to the **anal canal**.

Anal canal : It is the last 2cm of the digestive tract. It ends at the anus. The canal has two sphincters, namely the internal anal sphincter and the external anal sphincter.

3.5 Respiratory system

The process of respiration involves movement of air in and out of the lungs, gas exchange between air in lungs and the blood, transport of O₂ and CO₂. These processes are facilitated by working together of well developed respiratory organs and the circulatory system.

The respiratory organs include **nasal cavity, pharynx, larynx, trachea, bronchi** and **lungs**. These organs are organised into **upper** and **lower respiratory tracts**.

Upper respiratory tract.

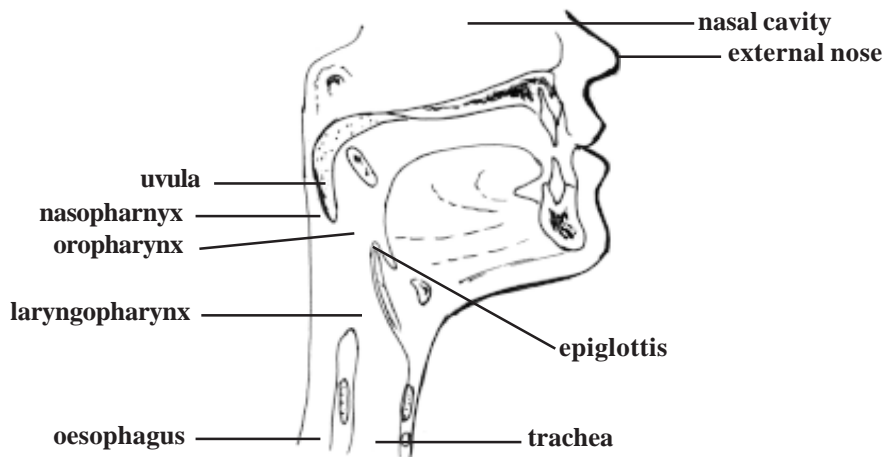

Fig.3.5.1. Upper Respiratory tract

1. Nasal cavity : The nasal cavity follows the external nose. The nose is a visible prominent structure. Internally it is supported by cartilage plates. The bridge of the nose is formed of the nasal bones and extension of the skull

bones(frontal and maxillary). The respiratory passage is divided into two chambers by a median partition. The nasal passage opens to the outside through external nostrils. It opens inside by internal nostrils at the pharynx.

2. Pharynx : The buccal cavity and the nasal passage open into the pharynx. It is a common pathway that opens into the oesophagus of the alimentary canal and larynx of the respiratory system.

The pharynx is divided into three regions, namely the **nasopharynx**, the **oropharynx** and the **laryngopharynx**.

The **nasopharynx** extends from the internal nostril to the region of the **uvula**. The uvula is a soft outgrowth hanging in between the posterior part of the oral cavity and the pharynx. It prevents the entry of food into the nasal cavity. The wall of the nasopharynx is lined by ciliated columnar epithilium. The middle ear opens into the nasopharynx through two auditory tubes. This arrangement is meant for equalizing the air pressure between the atmosphere and the middle ear. The inner surface of the nasopharynx also contains the pharyngeal **tonsil** or **adenoid** meant for defence against infections. An enlargement of the tonsil can interfere with breathing.

The **oropharynx** remains between the uvula and the epiglottis. The oral cavity opens into the oropharynx. Near the opening of the oral cavity 2 sets of palatine tonsils and lingual tonsils are present.

The laryngopharynx extends in between the epiglottis and the oesophagus.

3. Larynx : The larynx is seen just behind the pharynx and the buccal cavity. This region is surrounded by cartilages(3 unpaired and 6 paired). These are interconnected by muscles and ligaments.

The unpaired cartilages are the **thyroid**, **cricoid** and **epiglottis**. The thyroid cartilage is the largest. It is also known as the **Adam's apple**.

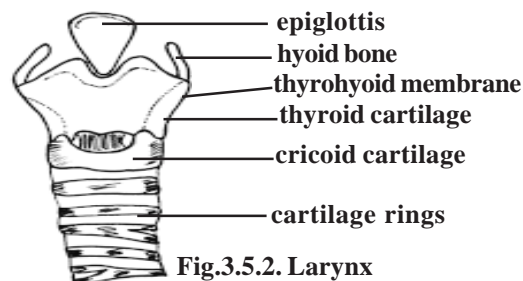

Fig.3.5.2. Larynx

The cricoid cartilage forms the base of the larynx. The other cartilages are placed above the cricoid. The **epiglottis** is attached to the thyroid. It projects as a free flap over the opening of the larynx. It prevents food particles from saentering into the tracheal tube.

The ligaments inside the larynx form the **vocal folds** or **vocal cords**. The vocal cords and the openings between them are called the **glottis**. The vocal cords are involved with sound production. The air moving past the vocal cords make them to vibrate. Louder sounds are made by increasing the amplitude of vibrations. Frequency of the vibrations can be altered by changing the length of the vibrating segments of the vocal cords. The length is altered by muscles attached to the cartilage. Males usually have longer vocal cords than females. The sound made by the vocal cords can be altered by the tongue, lips and teeth to form words.

4. Trachea (or wind pipe) : It is a membranous tube. The wall is made up of connective tissue and smooth muscles. The wall is provided support by 15-20 'C' shaped cartilage rings. They protect the trachea and keep it open all the time.

The inner wall of the trachea is lined by mucous membrane. It consists of ciliated columnar epithelium. The cilia of this epithelium help to propel mucus and foreign particles towards the larynx.

The length of the trachea is 10-12 cm. Its inner diameter is 12 mm. The trachea extends from the larynx to the level of the 5th thoracic vertebra. The basal part of the trachea divides to form 2 smaller tubes called the **primary bronchi** (sing : bronchus). The cartilage ring found at the basal region is called the **carina**. Foreign objects reaching carina stimulate a powerful cough reflex.

4. Lungs : The pair of lungs are the actual organs of respiration. Each lung is conical in shape. The base of the lung rests on the diaphragm. The right lung is larger than the left and it weighs around 620g. The left lung weighs 560g. The right lung has three lobes and the left lung has two.

The lungs are placed within the thoracic cavity. Each lung is surrounded by separate **pleural membrane**. The region inside the pleural membrane is named as the **pleural cavity**. This cavity is filled with **pleural fluid**.

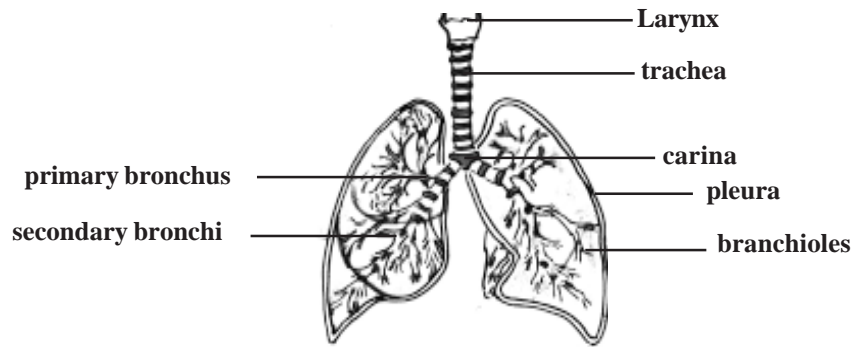

Fig.3.5.3. Lungs

The region in between the two lungs is named as the **mediastinum**. It is a midline partition, being occupied by the heart, trachea and oesophagus.

Structures such as the primary bronchi, blood vessels, nerves and lymphatic vessels enter or exit the lungs at a specific region on the inner margin of the lungs. This region is known as the **hilum**. All structures passing through the hilum are referred to as the **root of the lung**.

The primary bronchi on entering into each lung divide further into **secondary bronchi**. There are two secondary bronchi in the left lung and three in the right lung. The secondary bronchi in turn give rise to **tertiary bronchi**. They divide still further and finally give rise to **bronchioles**. The diameter of the bronchioles is less than 1 mm. These bronchioles divide several times to become still smaller **terminal bronchioles**.

Like the trachea, the primary bronchi are supported by 'C'. shaped cartilages and smooth muscles. As the bronchi become smaller the cartilages are replaced by smooth muscles.

The terminal bronchioles end in small air filled chambers called **alveoli**. The alveoli are thin walled pouches. They collectively provide the respiratory surface for gaseous exchange. The wall of the alveolus is very thin providing a minimal barrier to gaseous exchange between air and blood. The thickness of the wall of the alveolus is as little as 0.05m. Studies have shown that in human lungs there are about 300 million alveoli. They provide a mean total alveolar surface area value of 143 m².

5.Thoracic wall and muscles of respirations.

Eventhough the lungs are the principal organs of respiration, the process of ventilation happens by an indirect method. Air pressure gradients between thoracic chamber and lung cavity due to thoracic enlargement and reduction cause ventilation of lungs. Thoracic modifications during respiration happen due to several muscles. These are called the **muscles of inspiration and expiration**. These muscles are the **diaphragm, external** and **internal intercostal muscles** between the ribs, **pectorals** and **scalene** (Ref. Muscular system).

3. 6. The Circulatory System

The multicellular organisation in animal world has resulted in the origin and evolution of circulatory system in animals. This arrangement facilitates internal transport of various substances to all organs and organ systems. Among majority of multicellular animals this system remains as a closed type. It has blood running inside closed blood vessels, the blood being pumped by heart. In man, as in all mammals there is a double circulation of blood. The primary circulation through pumping action of heart, supplies blood to all regions of the body. The blood later returns to the heart. It is called the **systemic circulation** or **body circulation**. A similar circulation carries blood to lungs for oxygenation and returns it back to the heart. It is called the **pulmonary circulation**.

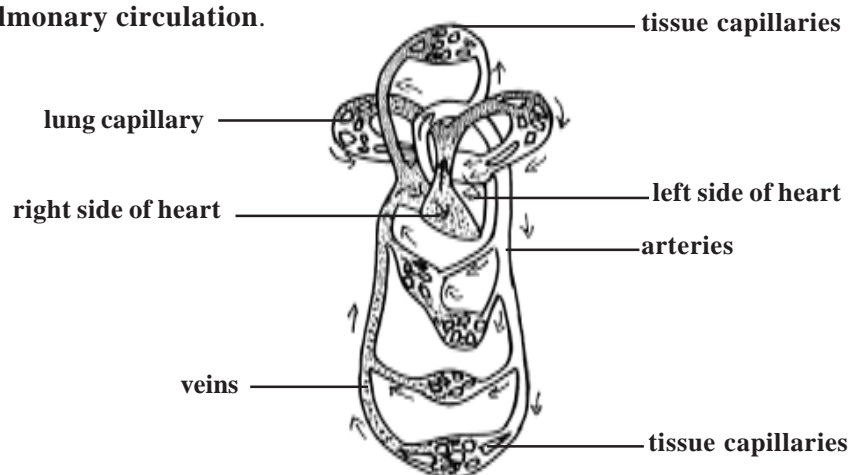

Fig.3.6.1. Systemic and Pulmonary circulations

Systemic and Pulmonary circulations

The most important component of this system is the **heart**. It is a large, muscular, valved structure having four chambers. The chambers are the **right atrium, left atrium, right ventricle** and **left ventricle**. Each atrium opens into a corresponding ventricle. The right and left chambers are separated by **septa**.

Systemic circulation :- The left atrium receives oxygenated blood from the lungs, through the pulmonary vein. When the atria contract, blood from the left atrium is forced into the left ventricle. Later by a contraction of the ventricle, the blood leaves the heart through the aorta. The aorta is the single systemic artery emerging from the heart. By successive branchings, the aorta

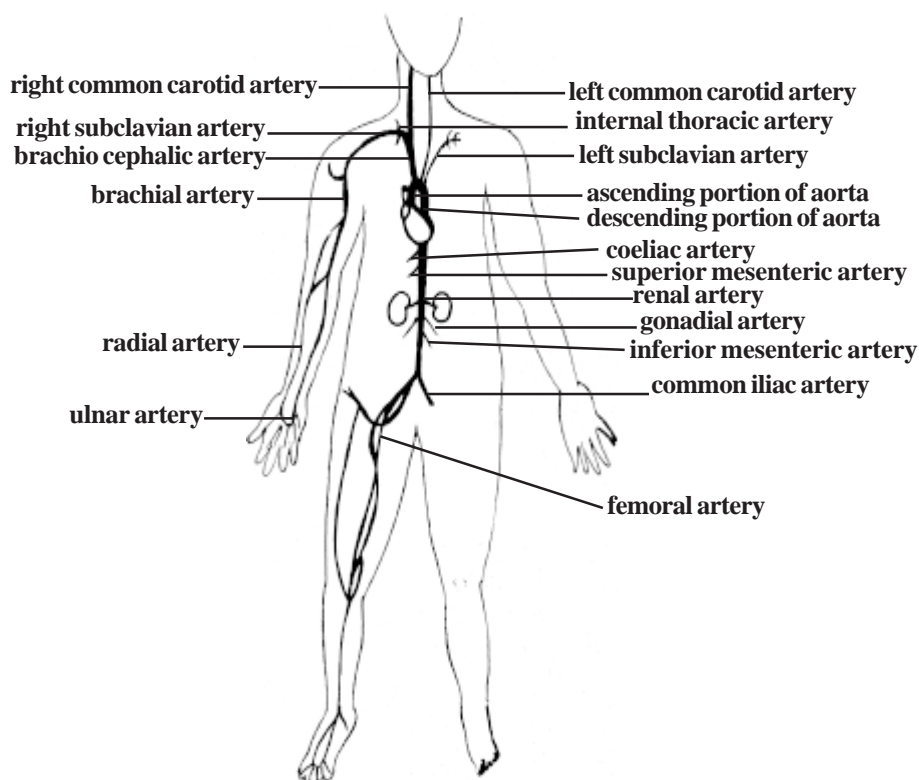

Fig. 3.6.2 Human - Arterial system

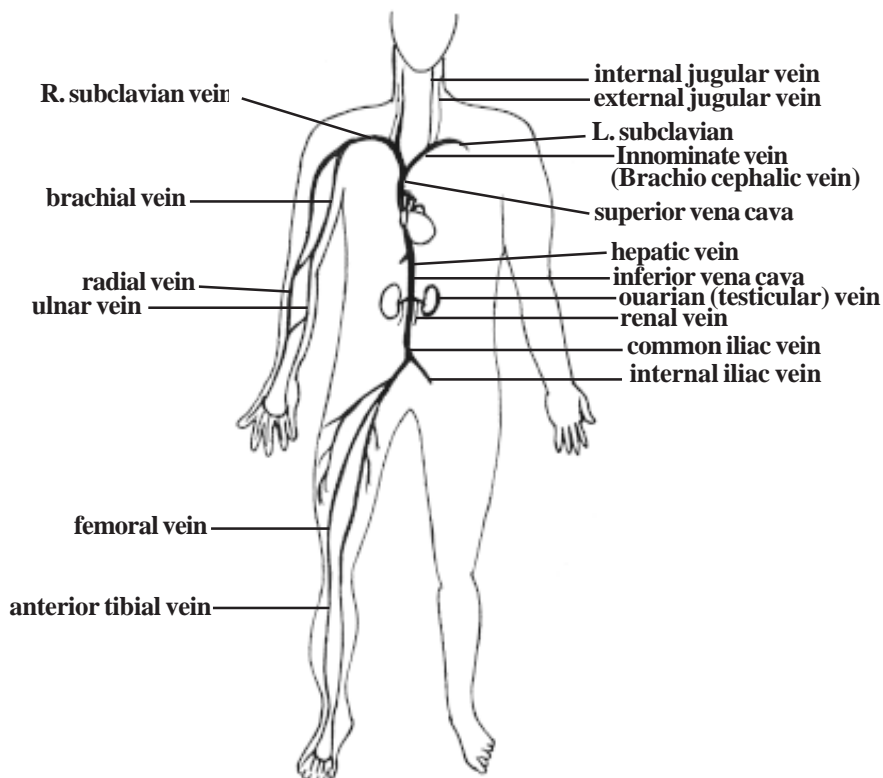

Fig. 3.6.4. Human - Venous system

gives rise to hundreds of arteries taking blood to all regions of the body. As the branchings happen, the arteries divide into numerous (4×10^6) arterioles. In the target organs they produce four times as many capillaries. A similar number of venules converge into each other forming veins of increasingly larger size. Finally, only two veins, the superior and inferior vena cavae return the blood to the right atrium. Thus the course of blood from left ventricles through the body organs and back to the atrium forms the systemic circulation.

Pulmonary circulation :- The venous blood from right atrium is conducted to the right ventricle. The ventricle expels the blood via the pulmonary trunk to the lungs. The oxygenated blood later returns by the pulmonary veins to the left atrium. This circulation from right ventricle to the left atrium via the lungs is termed the pulmonary circulation.

Portal circulation :- In the systemic circulation the venous blood passing through spleen, pancreas, stomach and intestine is not carried back directly to the heart. It passes through the **hepatic portal vein** to the liver. This vein begins as capillaries from the visceral organs and ends in the liver again as capillaries. These capillaries converge to form the **hepatic vein** which joins the inferior vena cava, conveying blood to right atrium. This route is the portal circulation.

Components of Circulatory system

Blood vessels

The blood vessels carrying blood away from the heart are the **arteries**. The **Veins** carry blood towards the heart. The arteries and veins are named and classified according to their anatomical position. They can also be classified according to their size and wall structure. Functionally, arteries are subdivided into conducting, distributing and resistance vessels.

1. **Conducting vessels** :- These are large arteries from the heart and their main branches. the walls of these vessels are elastic in nature.
2. **Distributing vessels** :- These are smaller arteries reaching individual organs. They branch into the organs. They have muscular walls.
3. **Resistance vessels** :- These are mostly arterioles. While these vessels are smaller, their walls are highly muscular. Hence these vessels can reduce pressure of blood due to peripheral resistance.
4. **Exchange vessels** :- These are the capillaries. The walls of these vessels allow exchanges between blood and the tissue fluid surrounding the cells. The substances commonly exchanged are oxygen, carbon-di-oxide, nutrients, water, inorganic ions, vitamins, hormones, metabolic products and antibodies.

5. Capacitance or reservoir vessels :- These are the larger vessels and veins. These are of varying sizes. They collect and convey blood back to the heart. The higher capacitance of these vessels is due to their distensibility. Hence their blood content is more, even at low pressure. The number of such veins is also enormous.. Thus the veins are called as the “**blood reservoirs**”

Structure of blood vessels

The blood vessels show a vast range of structural modifications. However a few basic patterns can be studied.

A blood vessel consists of a **wall** and a **lumen** or cavity. The wall of the blood vessels is made up of 3 distinct layers or **tunica**. They are the **tunica intima**, **tunica media** and **tunica externa** or **tunica adventitia**.

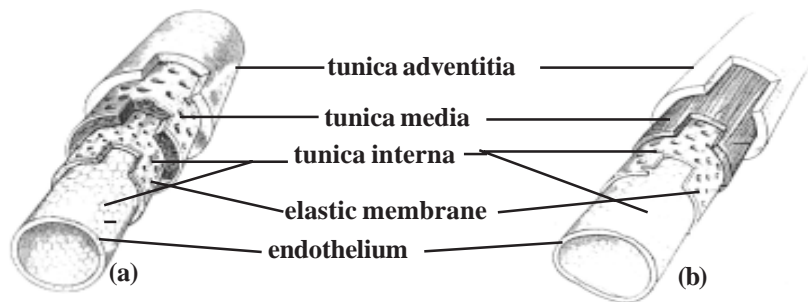

Fig.3.6.5. (a) Artery (b) Vein - Structural comparison

The tunica intima is formed of an endothelium, a delicate connective tissue and elastic fibres. The tunica media contains smooth muscle cells. It causes **vasoconstriction** and **vasodilation**. The **tunica externa** is composed of connective tissue. The composition and thickness of layers varies with the diameter of the blood vessels and the type.

Types of blood vessels

1. **Large elastic arteries** :- The walls of these arteries contain elastic fibres. The smooth wall measures about 1micron in thickness. It gets stretched under the effect of pulse and recoils elastically.

2. **Muscular arteries** :- There are larger and smaller muscular arteries. The larger muscular arteries are inelastic and they have thick walls. The wall has 30-40microns in diameter in the layers of smooth muscles. Since they regulate blood supply, they are called **distributing arteries**. The small muscular arteries are capable of vasodilation and vasoconstriction.

3. **Arterioles** :- They conduct blood from the arteries to the capillary bed. These are small vessels capable of vasodilation and vasoconstriction.

4. **Capillaries** :- These are fine vessels found between arterioles and venules. They measure 5-8micron in diameter.

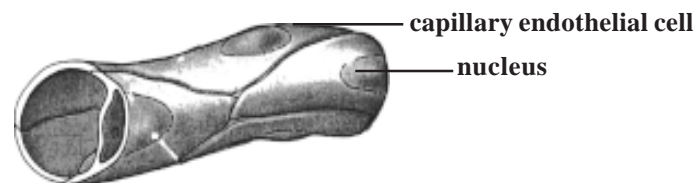

Fig.3.6.6. A Capillary tube

5. **Venules** :- These are tubes of flat, oval or polygonal endothelial cells. Each venule is formed by the convergence of two or more capillaries. Its diameter ranges upto 30micron.

6. **Veins** :- Veins seen in anatomy are **medium veins**. They run in between venules and **large veins**. Large veins transport blood to the heart.

Veins with diameter above 2 mm have valves. They are of semilunar type. They allow movement of blood towards the heart. There are several valves in the medium veins.

Branching of blood vessels :- When an artery divides into two equal branches, the original artery ceases to exist. Hence the branches are called **terminal branches**. The smaller branching vessels formed on the sides are called the **collateral branches**. When arteries are joined to each other it is named as **anastomosis**.

Blood supply to blood vessels :- As any other region, the cells and tissue on the wall of the blood vessel require nourishment. Some amount can diffuse from blood in the lumen. For vessels having diameter greater than 1 mm, diffusion of nutrients may not be possible. Such vessels have very minute vessels called **vasa vasorum** spread over them. They penetrate into the wall of the blood vessels.

Innervation of blood vessels :- The walls of the blood vessels are innervated by sympathetic nerve fibres. They regulate the contraction of the musculature. They effect vasoconstriction.

The Heart

The heart is a hollow, fibromuscular organ. It is somewhat conical or pyramidal in form. It is roughly the size of a closed fist. An average heart measures 12 cm from base to the apex. Transverse diameter at its broadest region is 8-9 cm. It is 6 cm thick antero-posteriorly. While in adult male the heart weighs 280-340 g, in female it weighs 230-280 g.

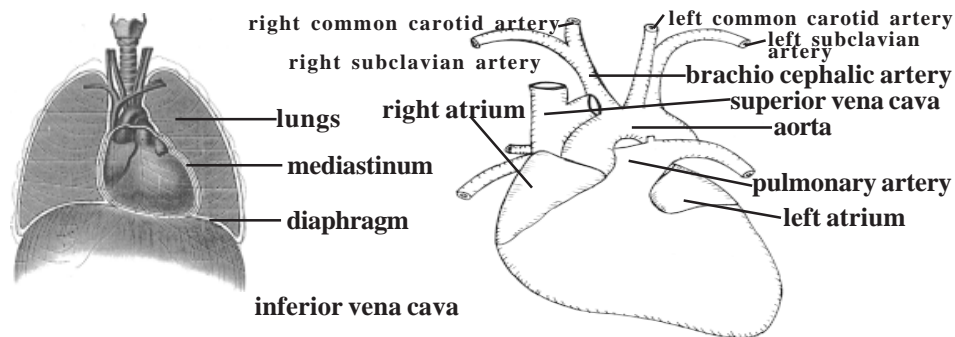

Fig.3.6.7. Location and External structure of the Heart

The thoracic organs such as heart, trachea and oesophagus form a midline partition called the **mediastinum**. The heart lies obliquely in the mediastinum.

The heart is surrounded by a double layered membrane called the **pericardium**. The outer layer is called the **fibrous pericardium**. The inner membrane is called the **serous pericardium**. In between heart and pericardium, there is a pericardial space. This space is filled with a fluid called the pericardial fluid.

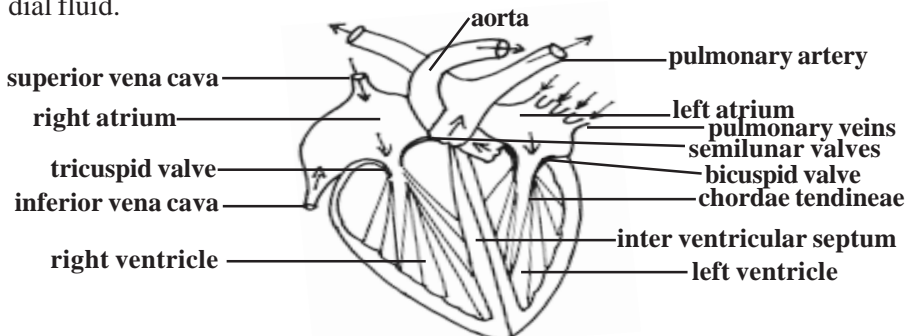

Fig.3.6.8. Internal structure of the Heart

The wall of the heart is made up of three tissue layers. They are the **epicardium**, **myocardium** and **endocardium**. The epicardium forms the smooth outer surface of the heart. The middle myocardium is composed of cardiac muscle. This layer plays an important role in the functioning of the heart. The **endocardium** forms the smooth inner surface. It is formed of squamous epithelium.

3.7. Lymphatic system

Lymphatic circulation along with blood circulation plays a key role in maintaining the fluidity in all regions of the body. It helps to maintain fluid balance in tissues and it absorbs fat from the digestive tract. It also functions as body's defence system against micro organisms and other harmful substances. This system includes lymph, lymphocytes, lymphatic vessels, lymph nodules, lymph nodes, tonsils, the spleen and the thymus gland.

Lymphoid cells and tissues - Lymphatic organs contain lymphatic tissues. These tissues primarily consist of **lymphocytes**. They also contain **macrophages**, **dendritic cells** and **reticular cells**. Lymphocytes are a type of white blood cells. They originate from red bone marrow and are carried by blood to lymphatic organs and **other tissues**. There are several classes of lymphocytes. The **B-lymphocytes** or **B cells** synthesize antibodies for recognizing and neutralising alien macromolecules. T- lymphocytes can recognize and selectively kill cells infected with viruses. B and T lymphocytes are produced from stem cells present in the bone marrow. The T lymphocytes get matured only after entering into **Thymus**, a lymphoid organ through circulation. Maturation and differentiation of B cells will occur in the bone marrow itself. Thus the thymus and bone marrow are described as central or primary lymphoid organs.

Thymus - It is a roughly triangular, bilobed gland. It is located in the mediastinum (ie., between the lungs). It lies between the sternum and the pericardium. Its size varies with age. It is largest in the early part of life (upto 15 years). At birth it weighs 10 - 15 g. After puberty it greatly decreases in size.

Each thymus lobe is surrounded by a thin capsule made of the connective tissue. It has 2 layers. The inner layer is the **medulla**, the outer layer is **cortex**. The lymphocytes are found only in cortex layer.

Lymph nodes - These are small round structures. Their size ranges from 1-25 mm. They are distributed throughout the course of the lymphatic vessels. These nodes are found all over the body. However they are concentrated as

aggregations in 3 regions of the body. These are the **inguinal nodes** in the groin, the **axillary nodes** in the axillary region and the **cervical nodes** of the neck.

The lymph enters the lymph nodes through afferent lymphatic vessels and exits through efferent vessels. The nodes contain open spaces called sinuses. The sinuses are lined with phagocytic cells.

Spleen - It is roughly the size of a clenched fist. It is located on the left side of the abdominal cavity. It has a fibrous capsule. The spleen contains two types of lymphatic tissues, namely the **red pulp** and the **white pulp**.

Tonsils - These are the largest lymph nodules. They provide protection against bacteria and other harmful materials. In adults the tonsils decrease in size and may disappear. There are 3 groups of tonsils in the pharyngeal walls. Of the three, the **palatine tonsils** are usually referred to as “the tonsils”. These are larger lymphoid masses on each side of the junction between the oral cavity and the pharynx. The **pharyngeal tonsil** or adenoid are found near the junction between the nasal cavity and the pharynx. The **lingual tonsil** is a loosely associated collection of lymph nodules on the posterior surface of the tongue.

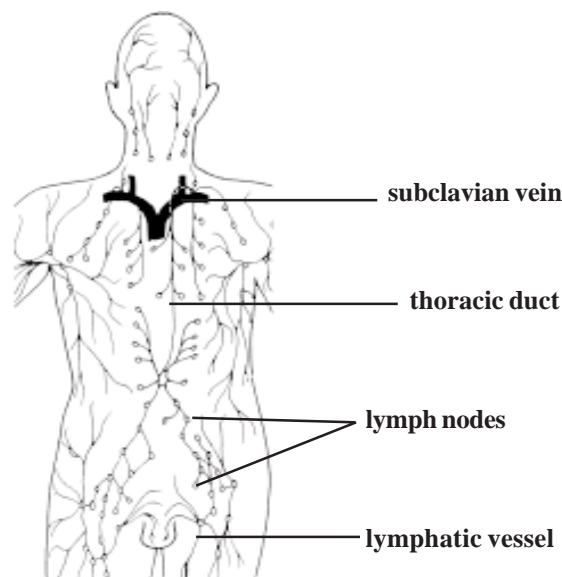

Fig.3.7.1. Lymphatic system

The lymphatic circulation - The lymph fluid from the tissues is drained by lymphatic capillaries. These capillaries though present in many tissues are absent in epidermis, hairs, nails, cornea, cartilages, CNS and bone

marrow. The lymphatic capillaries join into larger vessels. The larger vessels pass to local or remote lymph nodes. These vessels and associated lymph nodes are arranged in regional groups. Each group has its region of drainage. Nodes within a group are interconnected. Such regional groups with nodes and vessels are organised in (1) Head and neck (2) Upper limbs (3) Lower limbs (4) Abdomen and pelvis (5) thorax.

The regional vessels return to the venous blood circulation via the **right** and **left lympho venous portals**. Nearly eight lymphatic trunks **converge** at the site of the vertebral column and open into the venous portals nearer to the neck

3. 8. The Nervous System

A complete understanding of the human nervous system remains a challenge. Several billion cells remain associated with this system. The varying functions of these cells and the nervous system are responsible for human behaviour and activities. Hence, scientists from different fields collectively are interested in understanding the functioning of this system. Studies on brain and other related structures began several years ago. Even to-day thousands of scientists are involved in researches for knowing the structure and functioning of the brain. For a thorough knowledge of this system, further works in anatomy, physiology, molecular biology, psychology, medicine and other related fields are needed.

Basically the nervous system is formed of nerve cells or **neurons**. Neurons are responsible for transmission of impulses. They also help in realising, analysing and storing messages. They can stimulate muscles to work. The network of interconnected neurons in the nerves, brain and spinal cord have highly complicated methods of functioning.

A neuron has a basic cell structure called the **cyton**. The projections of the cyton are the **dendrites** and the **dendrons**. The inter communicating long projection is the **axon**. There are variations in the shape of the cyton, number of dendrons and nature of axon.

A neuron is interconnected with the dendrite of the neighbouring neuron through the **endplate** of the axon. Such specialized connections are called as **synapses**. In the terminal regions of the effector nerves the axon of the nerve cells are in contact with the **muscle tissue**. These joints are named as **neuro - muscular junctions**.

The structure of a peripheral nerve

A nerve is made up of several nerve fibres. A nerve fibre contains axons with their coverings called **schwann cells**. The fibres are grouped into **fasciculi**. The number and pattern of fasciculi vary in different nerves. Thus a nerve trunk possesses many such fasciculi. Such a trunk is surrounded by an **epineurium**. The individual fasciculi are enclosed by a multilayered **perineurium**. The perineurium surrounds the **endoneurium** or intra fascicular connective tissue.

In a peripheral nerve the epineurium constitutes 30 -70 % of the total cross sectional area of the nerve bundle. The thickness is more when there are more fasciculi. A layer of fat in the epineurium provides a 'cushion' effect to the nerve.

The perineurium contains alternating layers of flattened polygonal cells. The endoneurium remains condensed around axons. The components of the endoneurium remain bathed in endoneurial fluid.

The fasciculi of the nerve are supplied blood by **vasa nervosum**. These minute blood vessels radiate upto the endoneurium.

Nervous system

The organs of the nervous system are continuous in nature. However, for study purposes it can be divided into systems and organs.

A. Central nervous system (C N S)

This system includes the **brain** and the **spinal cord** or medulla spinalis. They are protected by surrounding bones. While the brain is located within the **cranium**, the spinal cord is placed within the **vertebral canal** of the vertebrae. Through an opening called **foramen magnum**, the spinal cord descends down from the brain.

B. Peripheral nervous system.

It consists of nerves and ganglia. The nerves that are formed from the brain are called the **cranial nerves**. There are 12 pairs of cranial nerves and 31 pairs of spinal nerves.

C. Autonomous nervous system.

The nerves in this system transmit impulses from the C N S to smooth muscles, cardiac muscles and glands. It is also called the **involuntary nervous system**. It is subdivided into sympathetic and parasympathetic divisions.

1. Brain

The brain is safely kept inside the cranial vault. Inside the skull the brain is surrounded by three protective coverings. They may be grouped under two divisions.

1. **Pachymeninx** -It includes the **duramater**.

2. **Leptomeninges** - In includes the **arachnoid mater** and **pia mater**.

The duramater is the outermost membrane. It is thick and inelastic in nature. The arachnoid mater is the middle covering over the brain. In between arachnoid and pia mater there is a space called the subarachnoid space. It contains cerebro-spinal fluid and blood vessels. The pia mater is a delicate membrane closely applied to the brain. This membrane contains blood capillaries supplying blood to the brain cells.

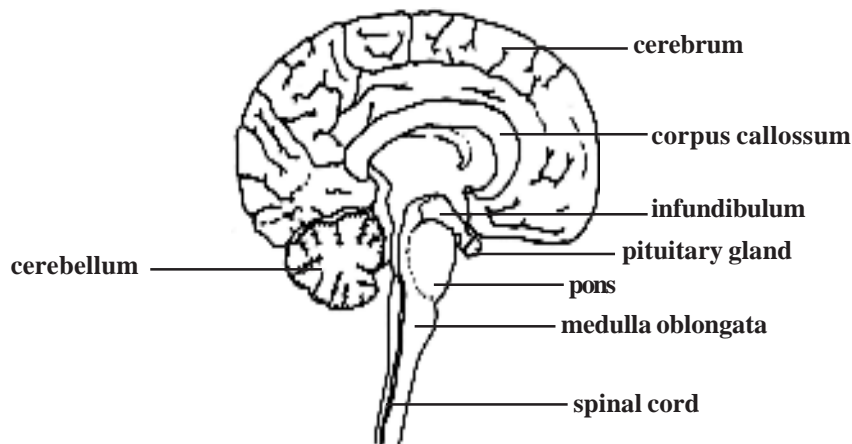

Fig.3.8.1 L.S. of the human brain

The human brain weighs about 1.3 Kg. It contains more than a billion neurons. Based on embryological development the brain can be divided as follows.

1. **Prosencephalon (Fore brain)** - It consists of the cerebrum and the diencephalon. The cerebrum is the largest part of the brain. It is divided into right and left hemispheres by a **longitudinal fissure**. However, at the base the two hemispheres are connected by a sheet of nerve fibres called the **corpus callosum**.

The outer surface of the cerebrum is called the **cortex** or **grey mater**. It is 2 to 4 mm thick. The inner content of the cerebrum is the **white mater**. The surface of the cerebrum has several folds called the **gyri**. They greatly increase the surface area of the cortex. The shallow grooves in between the gyri are called the **sulci**. A **central sulcus** runs in the lateral surface of the cerebrum from superior to inferior region.

Each cerebral hemisphere is divided into four lobes. They are the **frontal** at the front, the **parietal** towards the top of the head, the **temporal** on the side and the **occipital** at the rear.

The **diencephalon** contains the **thalamus** and **hypothalamus**. This region is found between the cerebrum and the brain stem.

The thalamus has a cluster of nuclei which act as the relays for particular sensory pathways. Just beneath the thalamus, the hypothalamus is present. It contains reflex centres linked to the autonomic system. A funnel shaped stalk called the **infundibulum** extends from its floor. It is connected to the **neurohypophysis** of the **pituitary gland**.

2. **Mesencephalon (mid brain)** - It is the smallest region of the brainstem. On its dorsal surface there are four rounded bodies called the **carpora quadrigemina**.

3. **Rhombencephalon (hind brain)** - The three main regions of the rhombencephalon are the **medulla oblongata**, the **pons varoli** and the **cerebellum**.

The **cerebellum** consists of two hemispheres. Its surface has many ridges called **folia**. The cerebellum consists of three parts. They are the small anterior **floconodular** lobe, a narrow central **vermis** and two large **lateral hemispheres**.

The **pons** is just superior to the medulla oblongata. It contains ascending and descending nerve tracts.

The **medulla oblongata** is about 3 cm long. It is continuous with the spinal cord. It remains as a bridge between the brain and the spinal cord.

Brain stem - The medulla oblongata, pons and mid brain form the brain stem. It connects the spinal cord to the brain. Ten of the twelve cranial nerves enter or exit the brain through the brain stem.

Spinal cord - The spinal cord extends from the foramen magnum to the level of the second lumbar vertebra. It is considerably shorter than the vertebral

column. There are two enlargements in the spinal cord. They are the **cervical** and **lumbar** enlargements. Below the lumbar enlargement the spinal cord tapers to form a cone like region called the **conus medullaris**. A connective tissue filament called the **filum terminale** extends inferiorly from conus medullaris to the coccyx. The conus medullaris and the nerves extending below resemble a horse's tail. Hence it is called **cauda equina**.

A cross section of the spinal cord reveals a central grey portion and a peripheral white portion. The white matter consists of nerve tracts and the grey matter consists of neuron cell bodies and dendrites.

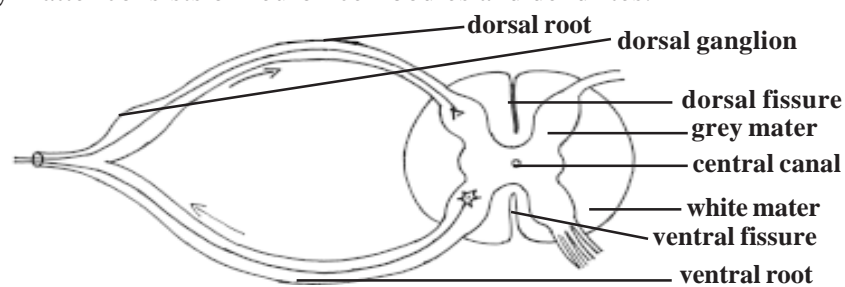

Fig.3.8.2. Cross section of the spinal cord

The dorsal and ventral sides have long fissures. There are 31 pairs of spinal nerves arising from the spinal cord. Each nerve has a **dorsal root** and a **ventral root** from the spinal cord. The dorsal roots have **dorsal root ganglia**.

Ventricles

The entire CNS remains as a hollow tube. The tube inside the adult brain forms ventricles.

Each cerebral hemisphere contains a large cavity called the **lateral ventricle**. It corresponds to the hypothetical first and second ventricles. The two lateral ventricles communicate with the third ventricle located in the centre of the diencephalon. This connection is made through two **interventricular foramina (foramen of Monro)**. The *third ventricle* inturn opens into the **fourth ventricle** found inside the medulla oblongata. This communication happens through a narrow canal called the **cerebral aqueduct** (aqueduct of sylvius). The fourth ventricle is continuous with the **central canal** of the spinal cord. The central canal extends nearly to the full length of the cord.

Cerebro-spinal fluid (CSF)

This fluid fills the ventricles of the brain and the central canal of the spinal cord. About 80-90 % of CSF is produced by specialized cells called

ependymal cells within the lateral ventricles. Remaining 10-12 % is produced by similar cells in the 3rd and 4th ventricles. These ependymal cells, their supportive tissue and the associated blood vessels together are called **choroid plexuses**. The plexuses are formed by invagination of the vascular piamater into the ventricles.

3. 9. The Sensory Organs.

Living organism respond to several stimuli such as light, heat, sound, chemicals, pressure, touch, stretch and orientation. These stimuli are felt by specific receptors. The receptors convert the stimuli into impulses in the nervous systems.

The **touch receptors** in the skin are the simplest receptors. Such receptors are single nerve cells responding directly to the stimulus. Other receptors are complex **sense organs**. On these organs the stimulus is channelled into a receptive region of the organ. Among the several organs, the most important are the **eyes** and **ears**.

The eye

The eye is formed of 3 coats or tunics.

Coats or tunic	Regions
1. Outer or fibrous	- sclera & cornea
2. middle or vascular	- choroid, ciliary body & iris
3. inner or nervous	- retina

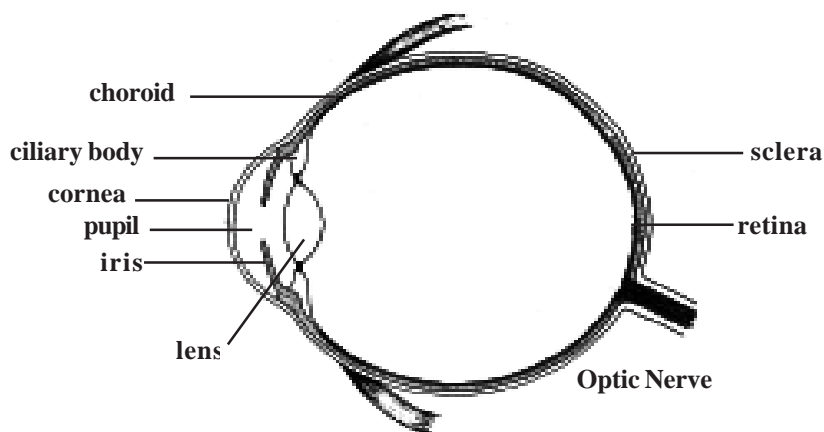

Fig.3.9.1. C.S. of human eye

The sclera is the white outer layer of the eye. It covers posterior five-sixths of the eye. This firm layer provides shape and protects the internal structures. A small region of the sclera can be seen as the “white of the eye”.

In the front, the outer layer forms a transparent region called the **cornea**. It permits entry of light. The cornea is made up of a connective tissue having collagen, elastic fibres and proteoglycans.

The middle tunic of the eyeball is the **vascular tunic**. It contains most of the blood vessels. The vascular tunic contains melanin containing pigment cells. It appears black in colour. A major part of the vascular tunic is found in association with the sclera and called the **choroid**. Anteriorly this layer forms the **ciliary body** and **iris**.

The **ciliary body** consists of smooth muscles called the **ciliary muscles**. Contraction of the ciliary muscles can change the shape of the lens.

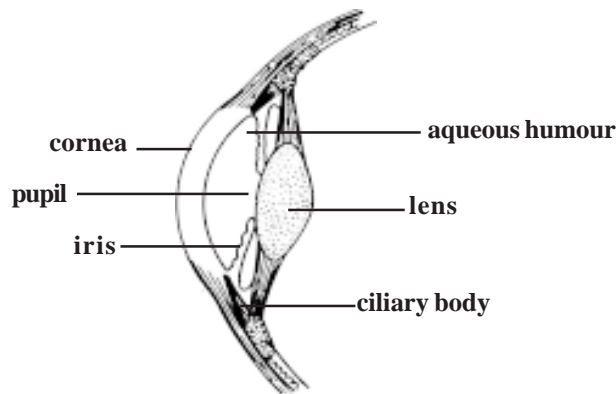

Fig.3.9.2. Front of the Eye

The **iris** is the coloured part of the eye. It may be black, brown or blue. It is a contractile structure surrounding an opening called the **pupil**. Light enters the eye through the pupil. The iris regulates such entry by controlling the size of the pupil.

The inner most tunic of the eye is the **retina**. It consists of an outer **pigmented retina** and an inner **sensory retina**. The sensory retina is light sensitive. It contains nearly 120 million photoreceptor cells called **rods** and another 7 million **cones**.

Compartments of the eye : The eye has 2 major compartments. There is a smaller compartment anterior to the lens. Behind the lens there is a larger compartment.

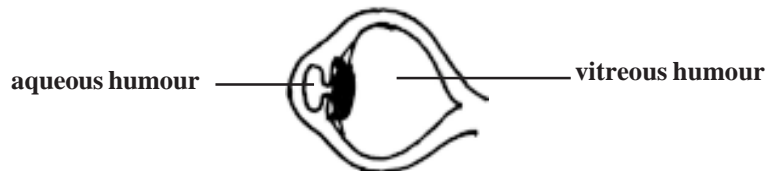

Fig.3.9.3. Compartments of the eye

The **anterior compartment** is divided into two chambers. There is an **anterior chamber** found between the cornea and iris. A smaller **posterior chamber** lies between the iris and lens. These two chambers are filled with a substance called the **aqueous humor**. It helps to maintain **intraocular pressure**.

The **posterior compartment** of the eye is much larger and it contains a transparent jellylike substance called **vitreous humor**.

The **eye lens** is a unique biological structure. It is transparent and biconvex. It is made up of long columnar epithelial cells called **lens fibres**. These fibres have an accumulation of proteins called **crystallines**. The lens is placed between the two eye compartments by suspensory ligaments.

The functioning of the eye is aided by accessory structures. They include the eyebrows, eyelids, conjunctiva and lacrimal apparatus.

The **eyebrows** prevent the sweat during perspiration from running down into the eye. They help to shade the eyes from direct sunlight.

The eyelids and associated lashes protect the eyes from foreign objects. The medial region where the eyelids join has a small reddish-pink mound called the caruncle. It contains modified sebaceous and sweat glands. There are two or three rows of hairs attached to the free edges of eyelids. Modified sweat glands called the **ciliary glands** open into the follicles of the eyelashes. It keeps them lubricated. The inner margin of the eyelids contain **Melbomian** glands. These glands produce **sebum** for lubricating the eyelids.

The inner surface of the eyelids and the anterior surface of the eye are covered by a thin, transparent mucous membrane called the **conjunctiva**.

The **lacrimal glands** or **tear glands** are situated in the superolateral corner of the eye orbit. They produce tear at the rate of about 1 ml / day. It

helps to moisten the eye surface and wash away foreign substances. At the corners of the eye there are small openings called the puncta. Each **punctum** inturn opens into a **lacrymal canaliculus**. The lacrimal canaliculi open into a lacrimal sac. This sac enters into a **nasolacrimal duct** which opens into the inferior nasal concha. These ducts help to drain the excess tear. The entire organization related to 'tear' is called the **lacrymal apparatus**.

Ears (The organs of hearing)

The ears are the organs of hearing and balance. They have three parts, namely external, middle and inner ears.

External ear - The fleshy part outside the head is called the **pinna**. It is made up of elastic cartilage and skin. It is followed by the **external auditory meatus**. This passage is lined with **hairs** and **ceruminous glands**. These glands produce **cerumen** or earwax. The hair and wax prevent foreign objects from reaching the **ear drum**. The ear drum or **tympanic membrane** is a oval, three layered structure. It separates outer and middle ears.

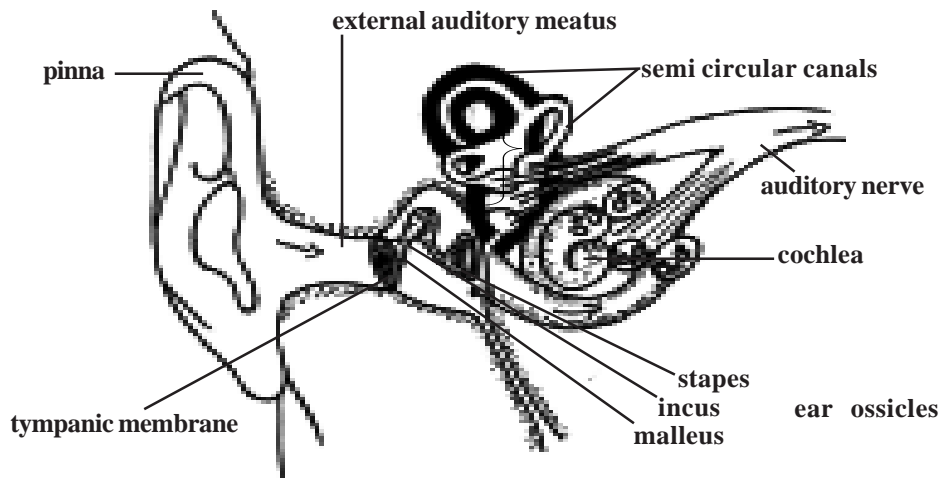

Fig.3.9.4. Ear - Inner structure

Middle ear - It is an air filled cavity. It contains three auditory ossicles called the **malleus**, **incus** and **stapes**. The handle of malleus is in contact with the inner surface of the ear drum. The head of the malleus is attached to the incus. While the stapes on one side is attached to the incus, its other side fits into the **oval window**. The oval window leads to the inner ear.

Inner ear - This region has tunnels and chambers inside the temporal bone

called the **bony labyrinth**. The bony labyrinth contains three regions called the **cochlea**, **vestibule** and **semicircular canals**. The oval window found in between the middle and inner ears communicates with the vestibule of the inner ear. The organs of the inner ear perceive the sound.

3.10 Endocrine system

Our body has two major regulatory systems. They are the **nervous** and **endocrine systems**. Together they regulate and co-ordinate the activities of all other body structures. The endocrine system sends information to the tissues it controls in the form of chemical signals. These signals, in the form of hormones are released into the circulatory system. They are carried to all parts of the body . Body cells are able to recognise the chemical signals and respond to them. The hormones of the endocrine glands regulate and control the functioning of several organs in the body. Thus, this system in general helps to maintain homeostasis. There are several endocrine glands in our body. The major glands are the **pituitary**, **thyroid**, **parathyroids**, **pancreas**, **adrenals**, **testes** and **ovaries**.

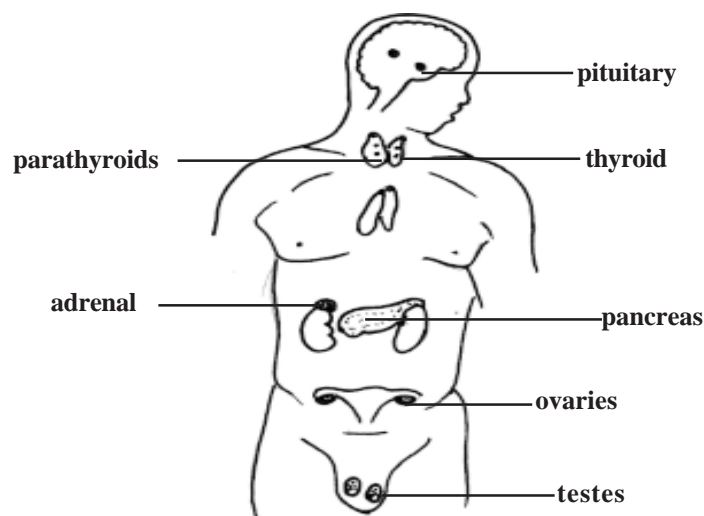

Fig.3.10.1. The Major Endocrine glands

An understanding of the structure and form of each endocrine gland, its secretory products and the means by which its activity is regulated is absolutely essential. This knowledge will help us to treat several diseases related to these glands.

Pituitary gland (or) Hypophysis

It is an organ, that secretes eight major hormones. These hormones regulate numerous body functions and controls the secretory activities of several other endocrine glands. The **hypothalamus** of the brain is connected to the pituitary. The posterior pituitary is an extension of the hypothalamus.

Structure of the pituitary gland.

This gland is approximately 1 cm in diameter. It weighs 0.5-1g. It is placed in a region called the **sella turcica** of the sphenoid bone in the floor of the skull. It is placed inferior to the hypothalamus. It is connected to it by a stalk of tissue called the **infundibulum**.

Based on origin and function the pituitary is divided into two parts. They are the **posterior pituitary** or **neurohypophysis** and **anterior pituitary** or **adenohypophysis**.

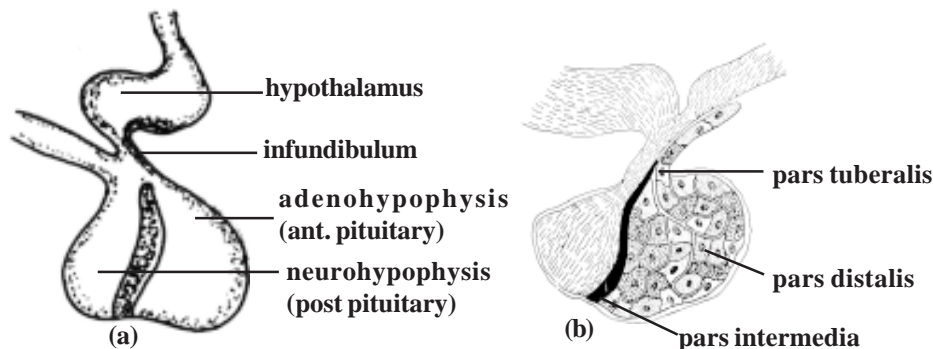

Fig.3.10.2. (a) Entire (b) L.S. of the pituitary gland

Posterior pituitary or Neurohypophysis.

The posterior pituitary is continuous with the brain. Hence it is called the **neurohypophysis**. During embryonic development, it is formed as an outgrowth of the inferior part of the brain in the area of the hypothalamus. The outgrowth of the brain, forms the **infundibulum**. The distal end of the infundibulum enlarges to form the **posterior pituitary**. Since this part of the pituitary is an extension of the nervous system, its secretions are known as **neurohormones**.

Anterior Pituitary or Adenohypophysis

During embryonic development an outpocketing of the roof of the oral cavity arises. It is called as the **Rathke's pouch**. This pouch grows

towards the posterior pituitary. Later, the pouch loses its connection with the oral cavity and becomes the anterior pituitary. The anterior pituitary is subdivided into three areas. They are, the **pars tuberalis**, **pars distalis** and **pars intermedia**.

Relationship of the pituitary to the brain.

There is a network of blood vessels on the hypothalamus. It is called the **primary capillary network**. A portal system called the **hypothalamohypophyseal portal system** extends from a part of the hypothalamus to the anterior pituitary (a portal blood vessel begins and ends as capillaries). The portal system in turn opens into the secondary capillary network of the anterior pituitary. The neurohormones produced by the hypothalamus are collected by the primary capillary network. Through the portal system they enter into the secondary network of the anterior pituitary.

Thyroid gland

The thyroid gland is composed of two lobes. They are placed on the lateral sides of the upper portion of the trachea. These lobes are connected by a narrow band of thyroid tissue called the **isthmus**. The isthmus extends across the anterior aspect of the trachea.

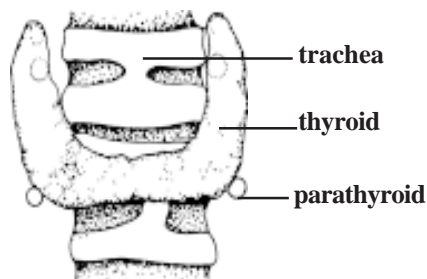

Fig.3.10.3. Thyroid and Parathyroid glands

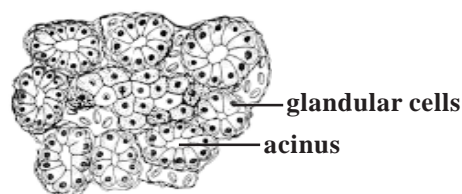

Fig.3.10.4. Thyroid C.S

The thyroid is one of the largest endocrine glands. It weighs approximately 20g. It is richly supplied with blood capillaries. It is more red than its neighbouring tissues.

The gland is composed of numerous follicles. They are small spheres. Their walls are made up of cuboidal epithelial cells. The central cavity or lumen of each follicle is filled with a protein called the **thyroglobulin**. It stores large amount of thyroid hormone. The thyroid secretes **thyroxine** and **calcitonin**.

Parathyroid glands.

The parathyroid glands are found in association with the thyroid glands. They are found embedded in the posterior part of each lobe of the thyroid gland. There are four parathyroid glands. Inside the glands the cells are organised in densely packed masses. The cells of the glands secrete **parathyroid hormone**.

Adrenal glands or Suprarenal glands.

These glands are found near the superior pole of each kidney. They are surrounded by adipose tissue. The glands are enclosed by a connective tissue capsule.

The adrenal glands are composed of an inner **medulla** and outer **cortex**. These regions are formed from two separate embryonic tissues. The medulla consists of closely packed polyhedral cells. They are centrally located in the gland. The cortex is composed of smaller cells. These cells form three distinct layers, namely the **zona glomerulosa**, the **zona fasciculata** and the **zona reticularis**. These layers are structurally and functionally specialized.

The adrenal medulla secretes two major hormones. They are epinephrine (or adrenaline) and norepinephrine (or noradrenaline). The hormones of the adrenal cortex are the **cortisol** and **aldosterone**.

Pancreas.

The pancreas lies between the greater curvature of the stomach and the duodenum. It is an enlarged structure. It is approximately 15 cm long. It weighs 85 -100g.

The pancreas is both an exocrine and an endocrine gland. The endocrine part consists of **pancreatic islets (islets of Langerhans)**. They are approximately 500,000 to 1,000,000 in number. The islets are distributed in the pancreas. The islets are composed of alpha (α) cells (20%) and beta (β) cells (75%). While the α cells secrete **glucagon** the β cells secrete **insulin**. A third type of cells called the delta (δ) cells (5%) have been identified. These cells secrete **somatostatin**.

3.11 Urinary system

It is customary to link the organs of urinary excretion and reproduction as urino-genital system. The suitability of this concept is questionable.

The urinary and reproductive organs differ in their embryological origin and development. In postnatal human beings, the association between the components of the urinary and the reproductive systems is very much limited. Hence the urinary and reproductive systems are considered separately.

The urinary organs comprise, two **kidneys (renes)**, **ureters**, the **urinary bladder (vesica urinaria)** and the **urethra**.

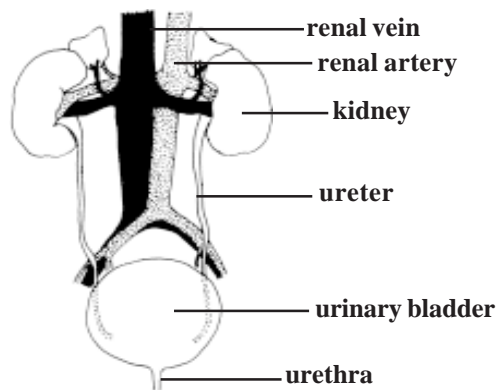

Fig.3.11.1. Human Urinary system

The kidneys.

The kidneys are bean shaped organs. In fresh state the kidneys are reddish brown in colour. They lie on the posterior abdominal wall. In the abdomen, the right kidney is slightly lower than the left. It is because of the presence of liver superior to it. The kidneys are surrounded by adipose tissue. Each kidney is about 11 cm in length, 6cm in breadth and 3cm in antero-posterior dimensions. In adult males the average weight of kidney is about 150g (in adult female 135g).

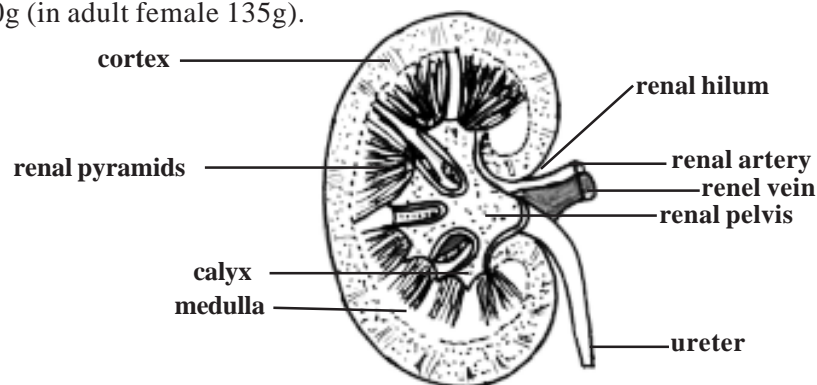

Fig.3.11.2. L.S. of Kidney

The inner margin of each kidney has a small depression called the **hilum**. The renal artery and nerves enter and the renal vein and the ureter exit at this region. The hilum opens into a cavity called the **renal sinus**.

Each kidney is enclosed by a fibrous connective tissue layer, called the **renal capsule**. Internally the kidney is divided into an outer **cortex** and an inner **medulla**. The medulla consists of several cone-shaped renal pyramids. Extensions of the pyramids called the **medullary rays**, project from the pyramids into the cortex. Extension of the cortex called **renal columns**, project between the pyramids. The tips of the pyramids are called the **renal papillae**. They are pointed toward the renal sinus. The renal papillae are surrounded by funnel shaped structures called the **minor calyces**. The minor calyces of several pyramids join together to form larger funnels called **major calyces**. There are 8-20 minor calyces and 2 or 3 major calyces per kidney. The major calyces converge to form an enlarged channel called the **renal pelvis**. The renal pelvis then narrows to form the **ureter**. The ureter leaves the kidney and gets connected to the urinary bladder.

Nephron.

The basic functional unit of each kidney is the **nephron**. There are approximately 1.3 million nephrons in each kidney. At least 450,000 of them must remain functional to ensure survival. Each nephron consists of an enlarged terminal end called the **renal corpuscle**, a **proximal tubule**, a **loop of Henle** and a **distal tubule**. The distal tubule opens into a collecting duct. The renal corpuscle, proximal tubule and distal tubules are in the renal cortex. The collecting tubules and parts of the loops of Henle enter the renal medulla.

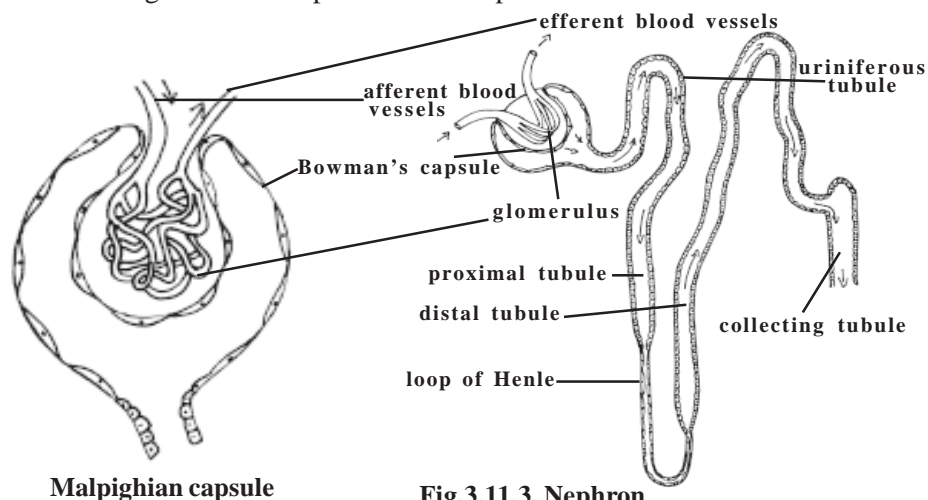

Fig.3.11.3. Nephron

Most nephrons measure 50-55 mm in length. 15% of the nephrons are larger and they remain near the medulla. These are called the **juxtamedullary nephrons**. They have larger loops of Henle.

The renal corpuscle of the nephron consists of a **Bowman's capsule** and a bunch of capillaries called the **glomerulus**.

In the Bowman's capsule the outer and inner layers are called **parietal** and **visceral layers** respectively. The outer parietal layer is composed of simple squamous epithelium. The inner visceral layer surrounds the glomerulus. It consists of specialized cells called **podocytes**. The walls of the glomerular capillaries are lined with endothelial cells. There is a basement membrane between the endothelial cells of the glomerular capillaries and the podocytes of Bowman's capsule. The capillary endothelium, the basement membrane and the podocytes of Bowman's capsule make up the **filtration membrane**.

The glomerulus is supplied with blood by an afferent arteriole. It is drained by an efferent arteriole.

The cavity of Bowman's capsule opens into the proximal tubule. The proximal tubule is also called the **proximal convoluted tubule**. It is approximately 14mm long and 60 µm in diameter.

Posteriorly the proximal tubule continues as the **loop of Henle**. Each loop has a descending limb and an ascending limb. The first part of the descending limb is similar in structure to the proximal tubule. The loops of Henle that extend into the medulla become very thin near the end of the loop. The first part of the ascending limb is also very thin and it consists of simple squamous epithelium, but it soon becomes thick. The distal tubules, also called the distal convoluted tubules are not as long as the proximal tubules.

Ureters and Urinary bladder

The ureters extend inferiorly from the renal pelvis. They arise medially at the renal hilum to reach the urinary bladder. The bladder is meant for temporarily storing the urine. The urinary bladder is a hollow muscular bag. It lies in the pelvic cavity. The size of the bladder depends on the presence or absence of urine. The bladder capacity varies from 120-320ml. Filling upto 500 ml is tolerated. Micturition will occur at 280ml. The ureters enter the bladder inferiorly on its posterolateral surface. The urethra exits the bladder inferiorly and anteriorly. At the junction of the urethra with the urinary bladder

smooth muscles of the bladder form the **internal urinary sphincter**. Around the urethra there is another external urinary sphincter. The sphincters control the flow of urine through the urethra.

In the male the urethra extends to the end of the penis where it opens to the outside. In male the urethra is 18-20cm long. In the female the urethra is shorter. It is about 4 cm long and 6 mm in diameter.

3.12. Reproductive system

The process of sexual reproduction is a wonderful act in nature. This process, apart from ensuring a healthy progeny provides an opportunity to produce enormous range of genetically varied offsprings. Organisms have adopted several strategies for sexual reproductive processes. Such adaptations have resulted in suitable morphological, anatomical and behavioral modifications. Human reproductive organs as internal and external genitalia are highly sophisticated yet simple in their functioning. The functioning is in accordance with psychological and endocrinological thresholds. **An academic approach towards an understanding of the human male and female reproductive organs and their functions will go a long way in avoidance of unethical, unhealthy and unhygienic practices encountered at specific periods in life.**

Male reproductive organs

The male reproductive system consists of the **testes** (singular : testis), **epididymides** (sing: epididymis), **ductus deferentia** or **vasa deferentia** (sing : ductus deferens, vas deferens), **urethra**, **seminal vesicles**, **prostate gland**, **bulbourethral glands**, **scrotum** and **penis**.

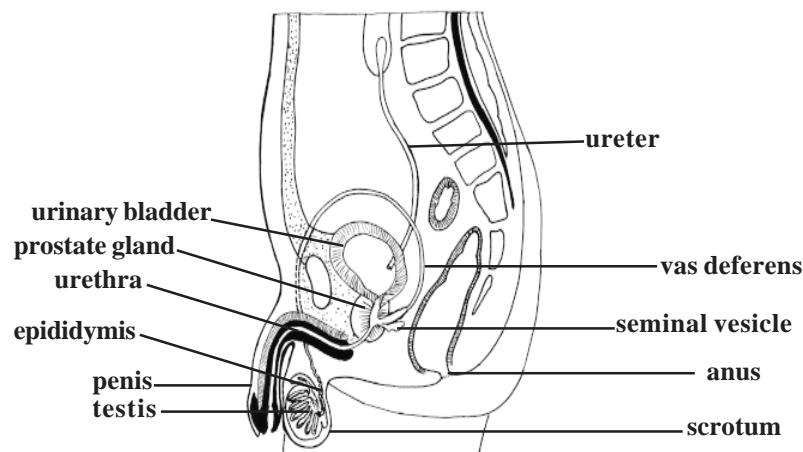

Fig. 3.12.1. Human male reproductive organs

Testes : The testes are the primary reproductive organs or gonads in the male. These are suspended in the **scrotum** by scrotal tissues.

The sperm cells are temperature sensitive. They do not develop normally at usual body temperatures. Hence the testes and epididymides in which the sperm cells develop, are located outside body cavity in the scrotum, where the temperature is low.

The left testis usually is 1 cm lower than the right. An average testis is 4-5 cm in length, 2-5cm in breadth. Its weight varies from 10.5-14g.

The outer part of each testis is a thick, white capsule called **tunica albuginea**. Internally the testis contains several incomplete septa. The septa divide each testis into about 300-400 cone shaped lobules. The lobules contain **seminiferous tubules** and interstitial cells or **Leydig cells**. Sperm cells develop within the seminiferous tubules.

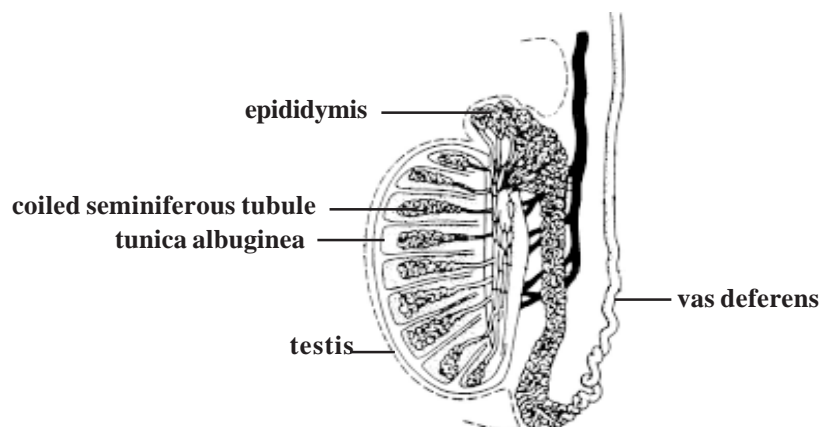

Fig. 3.12.2. L. S. of the Testis

The seminiferous tubules are extensive. The combined length of the tubules in both testes is nearly 800 metres. These tubules through a set of short, straight tubules open into tubular network called the **rete testis**. The rete testis in turn open into efferent ductules. Internally the tubules and ductules are lined by ciliated columnar epithelium. These cells help to move the sperm cells out of the testis.

Epididymis : It is formed of extremely convoluted ductules coming out of the testis. It occurs on the posterior side of the testis. The maturation of sperm cells occurs within the ductules of the epididymis.

Vas deferens or ductus deferens : It emerges from the tail end of the epididymis and ascends along the posterior side of the testis. It becomes associated with the blood vessels and nerves that supply the testis. Collectively these structures constitute the **spermatic cord**. Thus the spermatic cord consists of (1) Vas deferens (2) testicular artery and vein plexus (3) lymph vessels (4) nerves (5) fibrous processes and muscles. This cord enters into the pelvic region. The end of the vas deferens enlarges to form the **ampulla**. At this region the vas deferens is surrounded by smooth muscles capable of peristaltic contraction. They help to propel the sperm cells through the ductus deferens.

Ejaculatory duct : Nearer to the ampulla of each vas deferens there is a sac like **seminal vesicle**. It joins the ductus deferens to form the ejaculatory duct. These ducts are about 2.5 cm long. They project into the prostate gland and end by opening into the urethra.

Urethra : The male urethra extends from the urinary bladder to the distal end of the penis. It is about 20 cm long. It is a passageway for both urine and reproductive fluids. The urethra is divided into three parts. They are

1. The prostatic Urethra - It is closest to the bladder and passes through the prostate gland.

2. The membranous urethra - It is the shortest part of the urethra and it extends from the prostatic urethra.

3. The spongy urethra or penile urethra - It is the longest part of the urethra. It extends from the membranous urethra, through the length of the penis. There are several minute mucus secreting urethral glands opening into the urethral passage.

Penis - It is the male copulatory organ. It consists of two parts namely **the radix** or **root** and **the corpus** or **body**. The radix attaches the penis to the lower abdomen. The corpus is normally pendulous. It is covered by a loose skin.

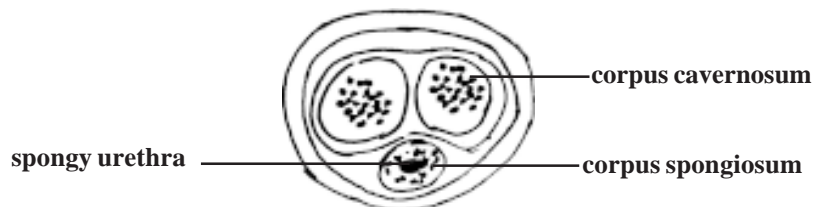

Fig. 3.12.3. C. S of Penis

The corpus of the penis consists of three masses of erectile tissue. Flooding these tissues with blood causes the penis to enlarge and become firm. These tissues are the right and left **corpora cavernosa** and the median **corpus spongiosum penis**. Most of the corpus is formed of the corpora cavernosa. The corpus spongiosum penis surrounds the urethra and near the end of the penis it expands into a conical, **glans penis**. Its swollen base is the **corona glandis**.

The skin over the penis is thin. It is loosely connected to the **tunica albuginea**. At the tip of the penis it is folded to form the **prepuce** or the **foreskin**. It overlaps the glans penis. The corona glandis and penile neck have numerous **preputial glands**.

Seminal vesicles - These are two sac-like structures located between the bladder and rectum. Each vesicle is about 5 cm long. Their secretions contribute about 70% of the seminal fluid.

Prostate - It is a firm structure. It is partly glandular and partly fibromuscular. It is found around the beginning of the male urethra. It is about 3 cm in diameter. It weighs about 8g.

The muscular part of the prostate may help in dilating the urethra to hold the seminal fluid (3-5ml) during the period of sexual excitement prior to ejaculation.

After the middle age the prostate often enlarges. It may project into the bladder and interrupt urination.

Bulbo-urethral gland - These are two glands. They are small round masses about 1 cm in diameter. They lie lateral to the membranous urethra. Its secretion may control genito-urinary diseases.

Scrotum - It is a fibromuscular sac. It contains the testes and their associated ducts. It is divided into right and left by cutaneous raphe. Its left side is usually lower. The external appearance varies according to age and body temperature. The scrotal skin is thin and pigmented. It has numerous sweat glands and nerve endings.

Female reproductive organs

In human female the internal reproductive organs are the **ovaries**, **uterus**, **uterine tubes** and **vagina**. Externally the organs are the **mons pubis**, **labia majora** and **labia minora**, **clitoris** and **vestibular glands**.

Ovaries - These are paired structures. The two ovaries are placed on each side of the uterus in the pelvic region. They are greyish pink in colour. Each ovary is almond shaped. They are about 3cm long, 1.5cm wide and 1cm thick.

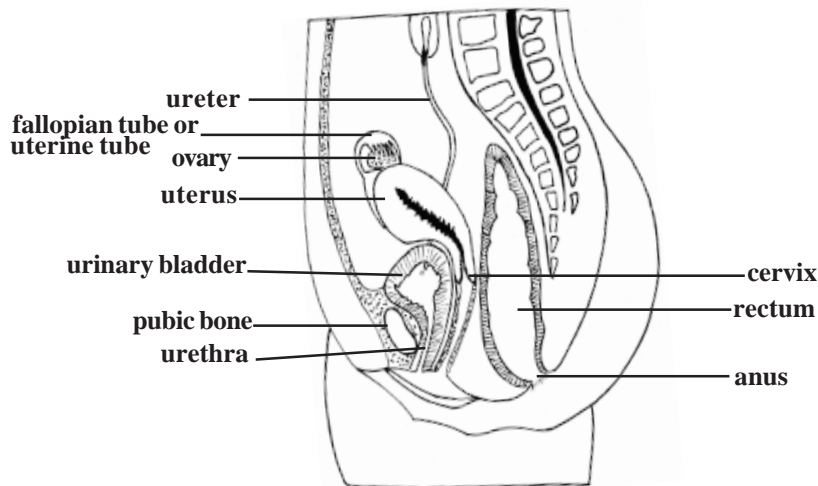

Fig. 3.12.4. Human female reproductive organs

The ovary is attached to the posterior surface of the inner body wall by a membranous fold called the mesovarium. The ovary is further supported by suspensory and ovarian ligaments.

Ovarian structure - In young female the surface of the ovary is covered by a layer of **ovarian surface epithelium**. It consists of a single layer of cuboidal cells. Beneath the epithelium the ovary is surrounded by a tough coat named **tunica albuginea**. It is made of collagenous tissue.

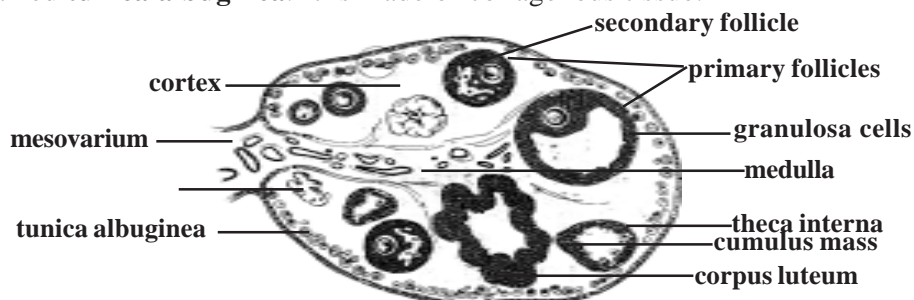

Fig. 3.12.5. Histology of the Ovary

The ovary proper is divisible into two regions, namely the **cortex** and the **medulla**. The cortex region contains the ovarian follicles. The medulla is interior. It receives blood vessels and nerves at the hilum.

After puberty **the cortex** forms the major part of the ovary. It contains **ovarian follicles** and **corpora lutea** of various sizes. Their size depends on the stage of menstrual cycle or age. The cortex is filled with stroma composed of collagen. The follicles are embedded in the stroma.

Ovarian follicles

The formation of the female gamete has many different phases and it is complex. At birth, the primordial follicles are found in the superficial zone of the cortex. They contain primary oocytes (about 25mm in diameter). Each one of them is surrounded by a single layer of flat follicular cells. The follicles undergo changes as the female attains puberty. The various follicular stages are :

1. **Primary follicle** - The follicle cells are converted from squamous to cuboidal cells. The follicular membrane or **membrana granulosa** becomes multilayered. The oocyte increases in size. It has an outer thick layer called the **zona pellucida**. The follicular cells divide and form **granulosa cells**.

2. **Secondary follicle** - It is about 20µm thick. The granulosa cells surround the oocyte and form a mound of cells called the **cumulus ovaricus**. The inner and outer theca become prominent. The **theca interna** is well established.

3. **Tertiary follicle** - Only one follicle reaches the tertiary stage. It increases in size (2mm diameter). Now it is called the **graafian follicle**. The oocyte and ring of cells surrounding the oocyte (corona radiata) break away and float freely in the follicular fluid. Finally the wall of the follicle ruptures and the contents are released into the peritoneum.

The ovary of the foetus at 5 months gestation has 7 million oocytes. At birth the ovary of the child contains about 1 million oocytes. Due to further degeneration at the time of puberty only about 40,000 oocytes remain. Of the 40,000 oocytes only about 400 undergo ovulation during the reproductive years.

Corpus luteum - It is formed after ovulation. The walls of the empty follicle collapse and fold extensively. The granulosa cells of the theca externa get enlarged.

They are now termed as **luteal cells**. They secrete hormones. In pregnancy the corpus luteum persists. Otherwise, it degenerates after 10-12 days. The connective tissue cells get enlarged. It becomes white in colour and is now called as the **corpus albicans**. In course of time it shrinks and disappears.

Uterine tubes (Fallopian tubes) - There are two uterine tubes or **oviducts**, one on each side of the uterus. Each one is associated with an ovary. Each tube is about 10 cm long. The terminal part of the tube is enlarged to form the infundibulum. It opens into the peritoneal cavity. The opening is called the **ostium**. The uterine tube consists of three parts. The part nearer to the infundibulum is called the **ampulla**. It is the longest part. That part of the tube nearer to the uterus is called the **isthmus**. It is narrow. The tubular part entering into the uterus is called the **uterine** or intramural part.

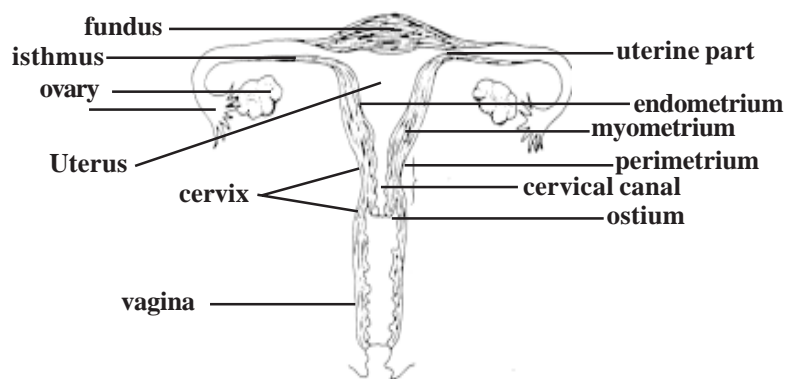

Fig. 3.12.6. Human female reproductive system

Uterus

It is a hollow thick walled muscular organ. It is pear shaped. It is about 7.5cm long and 5 cm wide. It weighs about 50g.

During pregnancy its weight may go upto 1kg. Its larger rounded part is called as the **fundus**. The narrower part is called as the **cervix**. The cervix is directed inferiorly. The middle part is the **body**. The uterus continues as the **cervical canal** and opens into the vagina through an opening called the **ostium**.

The wall of the uterus is three layered. The outermost layer is the **perimetrium** or **serous layer**. The major part of the wall is made up of the next layer called the **myometrium** or **muscular coat**. The innermost layer is the **endometrium** or **mucous membrane**. The endometrium is a functional layer. It undergoes menstrual changes and sloughing during female sex cycle.

Vagina - It is the female copulatory organ. It is a fibromuscular tube. It is about 10 cm long. It extends from the uterus to the outside. The vaginal passage is used during intercourse and it allows menstrual flow and child birth.

External Genitalia

Vestibule - The external female genitalia is known as the **vulva** or **pudendum**. It consists of the vestibule and its surrounding structures. The vestibular region remains in between the two **labia majora**. It contains the vaginal opening and the **urethral opening**. The vestibular region is surrounded by the **mons pubis** anteriorly and **labia majora** and **labia minora** on the lateral sides.

Mons pubis - It is a rounded eminence situated anteriorly. It is made up of subcutaneous adipose connective tissue. It is covered by coarse hair at the time of puberty. It corresponds to similar structure in the male.

Labia majora - These are two longitudinal folds of skin. They form the outer boundary for the vestibule.

Labia minora - These two small skinfolds lie between the labia majora. They remain nearer to the vaginal opening.

Clitoris - It is homologous with male penis. It is an erectile structure. It is found in the anterior margin of the vestibule. It is a sensitive region having sensory receptors.

Hymen vaginae - It is a thin mucous membrane. It is found within the vaginal orifice or opening. If the membrane completely closes the vaginal opening, it should be removed to allow menstrual flow. In young women the hymen may normally get torn during physical exercise. In some women it may be absent. It has no established function.

External urethral opening - This opening is about 2.5 cm below the clitoris. It is anterior to the vaginal opening. It remains as a small cleft.

Self evaluation

Choose the correct answer

1. The cornified region of the skin is formed of
 - a) stratum lucidum
 - b) stratum basale
 - c) stratum spinosum
 - d) stratum corneum
2. The goose flesh is formed due to the contraction of
 - a) diaphragm
 - b) erector pili
 - c) trapezius muscle
 - d) gluteus maximus
3. The number of facial bones are
 - a) 26
 - b) 25
 - c) 14
 - d) 22
4. The cervical vertebra supporting the head is
 - a) axis
 - b) atlas
 - c) sacral
 - d) lumbar
5. The broadest muscles are named as
 - a) deltoid
 - b) gracilis
 - c) longus
 - d) latissimus
6. The major breathing movement is due to
 - a) scalene
 - b) thoracic
 - c) diaphragm
 - d) intercostals
7. The largest salivary glands are
 - a) parotid
 - b) submandibular glands
 - c) sublingual glands
 - d) labial glands
8. The length of the duodenum in human alimentary canal is
 - a) 8 cm
 - b) 1.8 m
 - c) 9 cm
 - d) 25 cm

9. Breathing process can be interfered with due to
- a) closure of the ileo-colic valve
 - b) enlargement of the tonsil
 - c) closure of pyloric sphinctes
 - d) vibration of the vocal cord
10. The reduction in blood pressure may be caused due to
- a) distributing vessels
 - b) resistance vessel
 - c) exchange vessels
 - d) reservoir vessels
11. Vaso-dilation and vaso-constriction are caused by
- a) tunica intima
 - b) exchange vessels
 - c) tunica media
 - d) tunica adventitia
12. The wall of the blood vessels are supplied with blood by
- a) vasa nervosum
 - b) exchange vessels
 - c) vasa vasorum
 - d) capacitance vessels
13. Spleen is located on the left side of
- a) the abdominal cavity
 - b) the thoracic cavity
 - c) the lung
 - d) the kidney
14. The synapses are formed between
- a) nerves and muscles
 - b) nerve tissues
 - c) capillaries
 - d) organs
15. The cerebral hemispheres are connected by a sheet of nerve fibres called
- a) corpora quadrigemina
 - b) choroid plexus
 - c) corpus callosum
 - d) cauda equina
16. The interocular pressure is maintained by
- a) aqueous humor
 - b) vitreous humor
 - c) cerebro spinal fluid
 - d) lymph fluid
17. The hypophysis is connected with the brain through
- a) pars tuberalis
 - b) adeno hypophysis
 - c) hypothalamus
 - d) pars distalis

18. The average weight of human thyroid gland is

- a) 10 gms
- b) 20 gms
- c) 500 gms
- d) 20 kg

19. The inner layer of membrane lining the uterus is

- a) perimetrium
- b) myometrium
- c) endometrium
- d) serous layer

Part - II

1. What is keratinization ?
2. What are floating ribs ?
3. What is a synovial joint ?
4. Differentiate skeletal and visceral muscles.
5. Name the kissing muscles
6. Provide the human dental formula
7. What is carina ?
8. Provide the root of systemic circulation
9. What is the role of B-lymphocytes ?
10. What is a neuromuscular junction ?
11. What is choroid plexuses ?
12. What is meibomian gland ?
13. What is Rathke's pouch ?
14. What are podocytes ?
15. What is the role of prostate glands ?

Part - III

1. Give an account of the nail and its structure
2. Describe the structure of typical human vertebra
3. Give an account of the muscles of the lower limb
4. Give description of the human liver
5. Describe the paired and unpaired cartilages of larynx

6. Write notes on portal circulation
7. Give on account of the thymus
8. What is the structure of a peripheral nerve ?
9. Explain the organization of the lacrimal apparatus in human eye
10. Describe the endocrine nature of the pancreas
11. Provide the structure of human kidney
12. Give an account of corpus luteum

Part - IV

1. Write an essay on the structure and organization of the axial skeleton in human beings.
2. Give an account of the organs of digestion in the buccal cavity
3. Write an essay on structure and types of blood vessels
4. Provide a detailed description of the anatomy of human brain
5. Give an account of the structural organization of the hypophysis
6. Write an essay on the human male primary sex organs and associated structures.

Label the diagrams

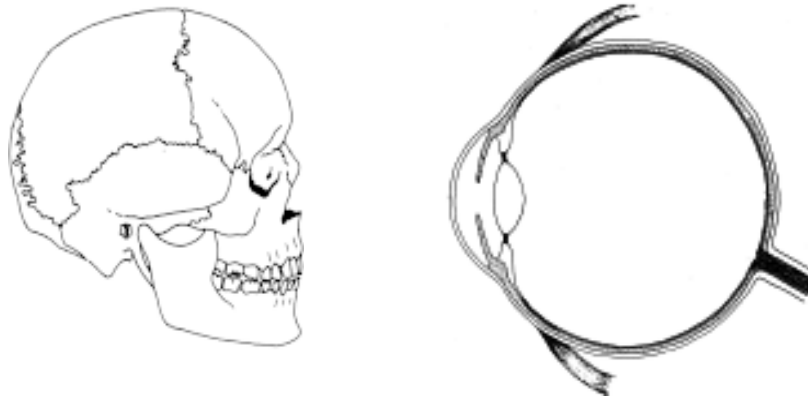

4. GENETICS

4.0. Introduction

Genetics is the study of inheritance or heredity. It deals with the transmission of characters, specific for that particular type of plant or animal, from the parent to the offspring of the next generation.

The history of Genetics is closely linked with the ancient cultural history of man. It began ten thousand years ago, when human beings changed from a nomadic life to the life of settlers. As settlers in early civilization they started living as groups. A need for food forced them to explore nature and adopt agriculture. The agricultural revolution in early human civilization opened the doors for very rapid improvements in human culture. They learnt to identify plants that could be grown and cultivated. Several cultivation processes evolved. They started selecting suitable varieties for agriculture.

Simultaneously they started domestication of animals. Many animals were brought under human control. Gradually they understood their reproductive methods. Hybridisation and generation of new varieties of animals like horses, dogs, cats and cattle happened. The idea of Genetics was adopted in everyday practice.

A scientific approach to understand inheritance was initially made by **Gregor Mendel**. He did hybridization experiments in *Pisum sativum* more out of curiosity and his devotion to science. He applied statistical methods to biological research.

Since the 'rediscovery' of Mendelism in 1900, Genetics has made rapid developments. The advancement in cell biology, microscopy, biochemistry and other disciplines provided the necessary infrastructure for this science to reach its climax. As of to-day all processes and causes for inheritance are well understood. Through the developments in Genetic Engineering, Biotechnology, Tissue culture and other methods we are trying to exploit nature. However, the steady processes of dominance of human beings on earth through their knowledge of science and skill in technology will also ensure the safety of earth in the times to come. In such a safeguarding the science of Genetics with all its related fields will play a key role.

4.1 Multiple Alleles

According to Mendelism, a genetical character is controlled by the

combined action of two genes or factors in the same loci of two homologous chromosomes. It means that each gene has two alternative forms or **alleles** and their expression are known as allelomorphs. Of these two, one is dominant and the other recessive. However, some genetical characters are determined by several forms of an allele known as **multiple alleles**. There are many examples for multiple allelism.

1. Skin colour in rabbits

Rabbits have five kinds of skin colour, **coloured** (agouti), **chinchilla**, **himalayan albino** and **albino, light grey**. Of these, the chinchilla variety is lighter in colour. Himalayan albino will have pink eyes, white coat colour and black colour in tips like nose, tail and feet.

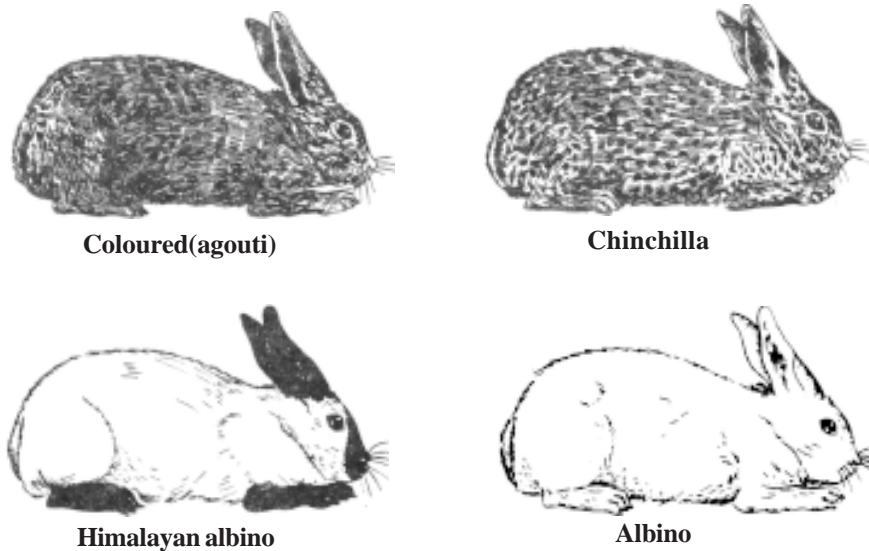

Fig. 4.1.1. Different colours in Rabbit

A crossing of a homozygous coloured rabbit with an albino resulted in following F_1 and F_2 generation.

Parents	CC (coloured)	x	c^a c^a (albino)
F_1	Cc^a (coloured)	x	Cc^a
F_2	CC 25% (coloured)	Cc^a 50% (coloured)	c^ac^a 25% (albino).

This result shows that coloured condition is dominant over albino.

Other possible crossings are

Parents	CC (coloured)	x	$c^h c^h$ (Himalayan albino)
F ₁	Cc^h (coloured)	x	Cc^h
F ₂	CC 25% (coloured)	Cc^h 50% (coloured)	$c^h c^h$ 25% (Himalayan albino)

Parents	$c^h c^h$ (Himalayan albino)	x	$c^a c^a$ (albino)
F ₁	$c^h c^a$ (Himalayan albino)	x	$c^h c^a$
F ₂	$c^h c^h$ 25% Himalayan albinos	$c^h c^a$ 50% Himalayan albinos	$c^a c^a$ 25% albino

The above crossings show that the genes **C**, **c^h** and **c^a** representing coloured, himalayan albino and albino are alleles of each other.

Parents	$c^{ch} c^{ch}$ (chinchilla)	x	$c^a c^a$ (albino)
F ₁	$c^{ch} c^a$ (light grey)	x	$c^{ch} c^a$
F ₂	$c^{ch} c^{ch}$ 25% (chinchilla)	$c^{ch} c^a$ 50% (light grey)	$c^a c^a$ 25% (albino)

In chinchilla, coat colour is lighter than the coloured (agouti). The coloured character is dominant over chinchilla. However F₁ hybrids between chinchilla and himalayan albino (**C^{ch}c^h**) or between chinchilla and albino (**c^{ch}c^a**) show **light grey** skin colour. The occurrence of light grey colour is due to partial expression of the gene for chinchilla in a heterozygous state.

Genotype

CC, Cc^h, Cc^a, Cc^h

Phenotype

coloured (wild)

$c^{ch}c^{ch}$	chinchilla
$c^{ch}c^h, c^{ch}c^a$	light grey
c^hc^h, c^hc^a	himalayan albino
c^ac^a	albino

2. ABO blood groups in human beings

The ABO blood group system in human beings was established by K. Landsteiner. It is based on the presence or absence of certain antigens. There can be two antigens A or B in the blood, resulting in four blood groups, namely A, B, AB and O. These are called **ABO blood groups** or **Landsteiner blood groups**.

The inheritance of ABO system illustrates a new principle in genetic control of phenotypes.

The blood of a person having A group will have the antigen A and a person having B group will have the antigen B. With these antigens A and B there are certain naturally occurring antibodies in the serum of the blood. The antibodies in a particular individual will be found only for those antigens which are absent in blood of this individual. The presence of antigens and antibodies occur as follows

Blood groups	Antigen	Antibody in the serum
A	A	anti B
B	B	anti A
AB	A and B	None
O	None	anti A and B

Antibodies in the blood of 'group A' will agglutinate red blood corpuscles of the blood group B. Similarly the antibody in blood 'group B' will agglutinate red blood corpuscles of the blood group A. Since no antibody is found in 'group AB' blood, it will not agglutinate any other group. 'Group O' will have antibodies for 'group A' and B. Hence 'group O' will agglutinate group A and B.

Compatibility of donor blood to that of the recipient will occur as follows.

Blood group of the donor	Blood group of the recipient
A	A and AB
B	B and AB

AB

AB

O

O, A, B, AB

From the table provided it is obvious that ‘group **AB**’ is **universal recipient**. ‘Group **O**’ is **universal donor**.

The gene for **ABO** system is conventionally represented by the symbol ‘**I**’. Alleles I^A and I^B code for the enzymes involved in the formation of the antigens A and B respectively and the allele ‘ I^O ’ for no known protein. Thus the genes can result in 6 possible genotypes but four possible phenotypes as found in the table

Blood group	Possible genotype
O	$I^O I^O$
A	$I^A I^A$ or $I^A I^O$
B	$I^B I^B$ or $I^B I^O$
AB	$I^A I^B$

The alleles I^A and I^B jointly express themselves in the individual, they are codominant. Both I^A and I^B are dominant to the recessive allele I^O .

Disputed parentage and blood groups

The identification of blood group may help to decide in cases concerned with parentage issues. By knowing the blood groups of parents, it is possible to determine the possible blood groups in the children. The impossibility of a particular blood group in the progeny can also be pointed out.

Parents	Blood group in progeny	Impossible blood groups
O x O	O	A, B, AB
O x A	O, A	B, AB
O x B	O, B	A, AB
O x AB	A, B	O, AB
A x A	A, O	B, AB
A x B	A, B, AB, O	None
B x B	B, O	A, AB
A x AB	A, B, AB	O
B x AB	A, B, AB	O
AB x AB	A, B, AB	O

Rh blood group

Rh factor in blood was discovered by **Landsteiner** and **Wiener** in 1940. It was initially discovered in rabbits, immunized with the blood of Rhesus monkey. The human beings whose blood will get agglutinated with rabbit serum were designated as Rh⁺, and whose blood if not agglutinated were designated as Rh⁻. Wrong transfusion can cause agglutination of blood in the recipient Hence before transfusion of blood, along with identification of ABO blood group, it is necessary to test compatibility of Rh factor.

The presence of Rh⁺ child in the uterus of the Rh⁻ mother can cause agglutination in the blood of the fetus. Even though such an unfortunate incident may not happen in the first pregnancy, it could occur in successive pregnancies. The death of the foetus in such cases is due to haemolytic anemia. This disease is called **erythroblastosis fetalis**.

4.2. Quantitive inheritance :-

Charles Darwin while working on his theory of Natural selection, recognised two principal types of variations, namely **continuous** and **discontinuous**. The continuous variations show the whole range of variations in a particular character. The discontinuous variations would appear all of a sudden and show no gradation.

Mendel in his work depended on sharp or alternate characters comprising discontinuous variations. For example, when tall and dwarf plants were crossed, in F₁ only tall plants appeared. Crossing F₁ plants, produced only tall and dwarf plants in the F₂ generation. Mendel discarded intermediate characters if any, seen.

However, by the end of the 19th century **Galton**, a British geneticist and statistician was interested in the study of continuous variations. He tried to find an answer for its origin. He called these characters as **metrical characters** and found them inherited.

Thus in the beginning of the 20th century two groups of geneticists emerged. They were the **mendelians** and the **biometricians**. While the mendelians considered that all hereditary differences are discontinuous and qualitative, the biometricians believed that hereditary variations are basically continuous and quantitative. These two views remained contradictory. Later, **Johansen** (1903), through his work on bean seeds proved that both the views of mendelians and biometricians were only partly correct.

Yule (1906) suggested that quantitative variations may be controlled

by large number of individual genes, with each gene having a small effect. Later on, such genes were called as polygenic systems. The hereditary processes operating through such system was explained through **multiple factor hypothesis**.

Multiple factors

Skin colour in human beings

The inheritance of skin colour in black and white populations in United States of America was worked out and reported by **C. B. Davenport in 1913**. In USA, marriages between black and white individuals has resulted in a population known as **mulattoes**. They have intermediate skin colour in the first generation. When the mulattoes marry among themselves, all shades of skin colours are obtained.

If the skin colour is due to genes in two loci **A** and **B**, the genotype of black and white persons will be **AABB** and **aabb** respectively. The genotypes of mulattoes will be **AaBb**. However the F_2 generation has yielded five or more shades of skin colour. The observed results on number of individuals with differing shades indicate the involvement of four or five gene pairs in the control of skin colour. The effect of these genes may be further modified due to **modifying genes**.

Studies have also shown that, the control of most characteristics are multifactorial. For example, in human beings several different gene loci are involved in determining characteristics such as body height and body mass.

An understanding of the polygenic influence on a specific genetic trait requires enormous data. The data are to be analysed employing several biostatistical and biomathematical tools.

From such studies it becomes clear that while at individual level the basic inheritance remains mendelian, at the population level it appears much more complicated.

4.3 Sex Determination

Differentiation as male and female sex and reproduction through sexual processes are basic phenomena in the living world. Sexual reproduction is a strategy for the production of diversity in nature. It is achieved through efficient functional anatomy of male and female individuals. In this natural system, the sex cells and the basic reproductive organs are the **primary sexual characters**. Morphological, Physiological and behavioural characters exhibited by

male and female of a species are called the **secondary sexual characters**. Thus the characteristic differences between male and female animals constitutes **sexual dimorphism**.

The fundamental mechanism concerned with sex determination are genetical in nature. These genetical methods vary in different animals.

A. Sex Chromosome mechanism

The chromosomal basis for the determination of sex was first proposed by **Clarence McClung** in 1902. He observed gametogenesis in grasshopper (**Xiphidium fasciatum**). He reported that while the somatic cells of the females had 24 chromosomes the males had 23 chromosomes. Similar observations were made in bugs and beetles by several other workers.

By further studies it was concluded that in dioecious organisms there are two types of chromosomes. Among them the chromosomes concerned with body or **somatic characters** were named as autosomes (A). The other type of chromosomes concerned with sex determination were called **sex chromosomes (X and Y)**.

Later it was found that sex chromosomes (X and Y) had structural differences. The cytological studies have shown that X-chromosomes in most cases are straight, rod-like and slightly longer. The Y-chromosome was found to be smaller with one end curved or bent to one side (as in *Drosophila*).

Types	Sub types	Sex chromosomes	Organisms
Heterogametic males	XX - XO	Females-2X Males - 1X	Plants like <i>Vallisneria spiralis</i> Bugs and grasshoppers
	XX - XY	Females-2X Males - XY	Man, other mammals <i>Drosophila</i> certain angiosperms
Heterogametic females	ZO -ZZ	Females-1Z Males - 2Z	Moths and butterflies
	ZW - ZZ	Females-ZW Males - 2Z	Gypsy moth fishes, reptiles, birds, mammals

Based on sex chromosomal determination of sex, there may be two types of organisms, namely 1. Heterogametic males 2. Heterogametic females.

Heterogametic males :- In this type of sex determination the female has two x-chromosomes. The males have only one x-chromosome. During gametogenesis the males could produce two types of gametes i.e., one type having 'X-chromosomes' and the other without 'X-chromosome'. Hence the males could be called the **heterogametic sex**. The females can produce only one type of gametes i.e., all eggs having one 'X'-chromosome each. Hence the female could be called the **homogametic sex**. Each type of sex determination has subtypes as shown in the table.

B. Genic balance mechanism

Further studies on sex determination showed that sex determination was not the inheritance of genes by the sex chromosomes alone. Studies on **intersex** and **supersex** indicated the operation of still more a complex mechanism for the determination of sex. Thus the **genic balance mechanism of sex** was discovered. It was first described by C.B Bridges in 1921.

In *Drosophila* it was discovered that the sex of an individual depends upon the ratio of x chromosomes to the autosomes. For sex determination, each haploid set of autosomes carry factors with a male determining value equal to one (1). Each x chromosome carries factors with a female determining value of one and a half (1.5). Hence in a normal male (AAXY), the male female determinants are in the ratio of 2 : 1.5 ('A' represents a haploid set of autosomes). Thus the genic balance is in favour of maleness. A normal female (AAXX) has the male female determination ratio of 2:3. Therefore the balance is in favour of femaleness.

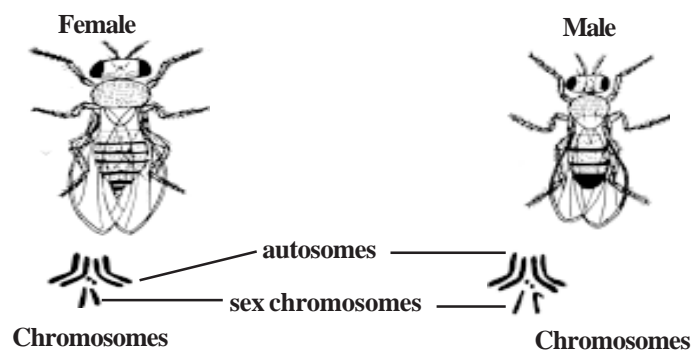

Fig.4.3.1. *Drosophila* flies

Phenotype	Number of X chromosomes	Sets Autosomes	X/A ratio
Super female	3	2	1.5
Normal female	Triploid	3	1.0
	Tetraploid	4	1.0
	Diploid	2	1.0
	Haploid	1	1.0
Intersex	2	3	0.67
Normal male	1	2	0.5
Super male	1	3	0.33

Sex determination in Human beings

The human sex determination mechanism to a larger extent resembles XX - XY type of *Drosophila*. However, the Y chromosome contains male determining genes and it is the determiner of fertility and sex of male individual.

Thus in human beings, the presence of Y chromosome determines maleness and its absence determines femaleness. Evidences to establish this viewpoint had been provided by certain abnormal conditions called syndromes.

Sex anomalies in Human beings

1. **Turner's syndrome** (XO Females) : In this abnormality the females are sterile and have short stature. They have webbed neck, broad shield-shaped chest, low intelligence, under developed breasts and poorly developed ovaries. These conditions result due to the presence of 44 autosomes and only one X chromosome in her body cells. This abnormality is known as Turner's syndrome.

2. **Klinefelter's syndrome** :- This syndrome is caused due to the presence of an extra X chromosome in males. This happens when an abnormal egg with XX chromosome is fertilized by a sperm carrying Y chromosome. The zygote will have three sex chromosomes (XXY). The resulting young one is an abnormal sterile male. The symptoms of this syndrome are the presence of small testicles, mental retardation, longer arms and high pitched voice.

3. **Super females** :- These females are also known as **Poly X females**. They possess an extra X-chromosome (44 autosomes +3 x chromosomes). The poly X females are mentally retarded and sterile.

4. **XYY males** :- Such males will have an extra Y chromosome (XYY). This condition results in mental retardation and criminal attitudes.

5. **Hermaphroditism** :- A hermaphroditic person will have one extra X and Y chromosome. The person will have both ovarian and testicular tissues. The external genitalia will not be well defined.

C. Male haploidy or Haplo-diploidy mechanism.

This mechanism is also known as arrhenotokous parthenogenesis. It is a common mechanism in several insects such as ants, bees and wasps. In these insects, fertilized eggs develop into diploid females and unfertilized egg into haploid males.

In a honey bee colony a queen bee can lay two types of eggs. They are the fertilized and unfertilized eggs. It happens by controlling the sphincter in the sperm receptacle of the female. The diploid female zygote can develop either into a queen or a sterile female worker bee. The sterile nature of the worker bee is due to poor nourishment. The haploid zygote develops into a male. This mechanism of sex determination helps to maintain the polymorphic nature in a honey bee colony.

Apart from genetical systems, the sexuality can also be controlled by various factors such as metabolism, environment and hormones.

Sex in *Bonellia*

Bonellia viridis is a marine worm. Its sex determination was studied by **F. Baltzer**(1935). The adult female worm is about 2.5 cm long. It has a well defined anatomical organization.

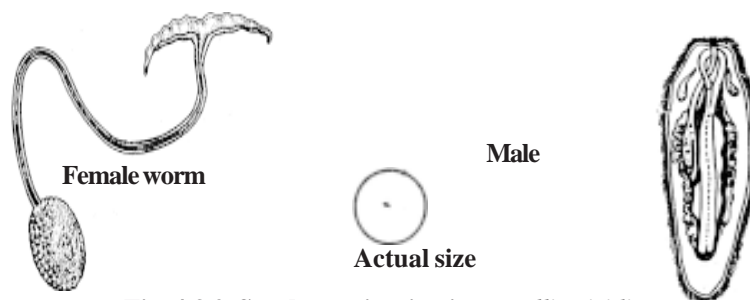

Fig. 4.3.2. Sex determination in *Bonellia viridis*

The male is very small and microscopic. Its body organs are rudimentary. The males normally live as parasites attached to females. All larvae of *Bonellia* are genetically similar. However a larva settling on the proboscis of an adult female becomes a male individual. If a larva develops in isolation (ie., in the absence of a female) it develops into female. If a developing male is detached from the proboscis of female, it becomes an intersex. From these observations it could be inferred that the proboscis of adult female secretes some hormone like substance and that substance suppresses femaleness and induces maleness in the larvae which remains attached.

4.4 Sex - linked Inheritance

Most of the inheritable characters are controlled by genes located in autosomes. The inheritance of traits related to autosomes normally follows Mendel's laws. Mendelian ratios are not obtained for those characters for which genes are exclusively located either in X or Y chromosome. The genes that occur only on X chromosomes are called as **X - linked genes**. Similarly, that the genes occur exclusively on Y chromosomes are called the **holandric genes**. The inheritance of X or Y linked genes is called as **sex linked inheritance**. Thus the sex linked inheritance may be X- linked, Y- linked or XY linked.

X - Linked inheritance

T. H. Morgan (1910) in his studies on inheritance of genes in *Drosophila* discovered that the pattern of inheritance of certain traits were found to vary with the sex of the parent and offspring. He found that the gene for white eye colour is X - linked. Further it was found to be recessive to another X - linked, dominant gene for red eye colour.

Red eyed female x white eyed male

When a wild red eyed female *Drosophila* is crossed with a mutant white eyed male, all the F_1 individuals (males and females) have red eyes. When the red eyed male and red eyed female of the F_1 were intercrossed, in the F_2 generation all the female flies were found to be red eyed. Among the males 50 % had red eyes and another 50 % had white eyes.

White eyed female x Red eyed male

When a white eyed female *Drosophila* is crossed with a red eyed male, all the female individuals in the F_1 generation are red eyed and all the males are white eyed. When these red eyed female individuals and white

eyed male individuals of F_1 are intercrossed the F_2 generation possessed 50 % red eyed and 50 % white eyed females. Similarly the male population of F_2 included 50 % red eyed and 50 % white eyed flies.

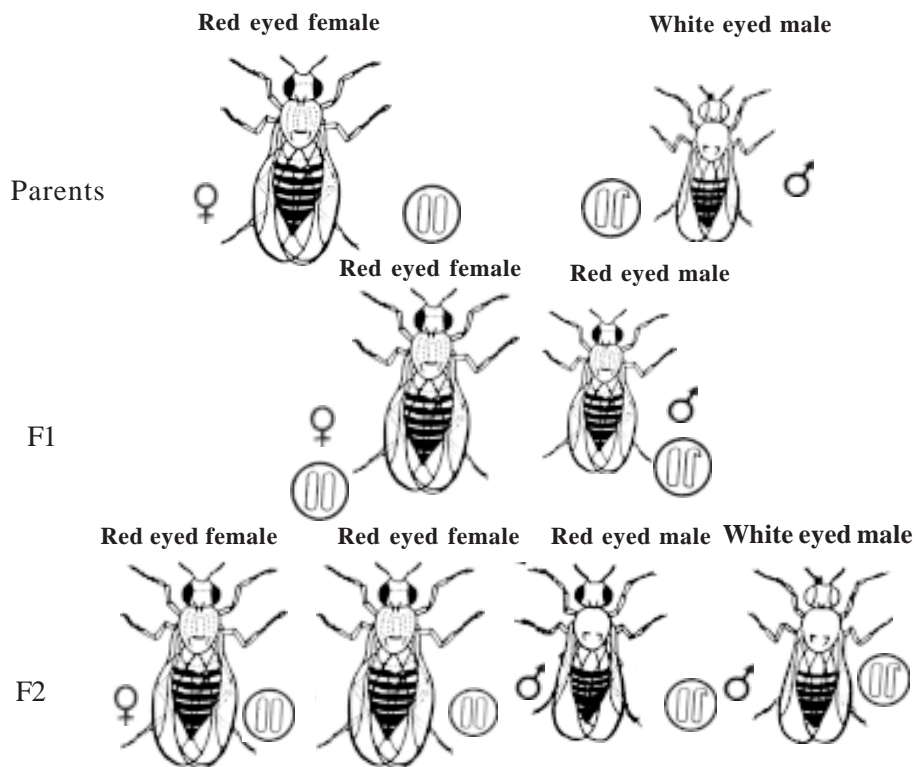

Fig.4.4.1. *Drosophila* - Red eyed female x White eyed male

Sex linked inheritance in Humans

Most of the sex linked characters in humans are **X - linked**. There are 150 confirmed X- linked traits known. Most of them are recessives.

Colour blindness :

The human vision is basically due to cells called rods and cones found on the retina of the eye. The cone cells are sensitive to red, green and violet light. The formation of colour sensitive cones is controlled by a dominant X-linked gene.

The recessive form of this gene is incapable of producing colour sensitive cones. Hence homozygous recessive females (X^cX^c) and Hemizygous recessive males (X^cY) are unable to differentiate between red and green colour. The frequency of colour blind women is less than colour blind men.

Colour - blind man x normal visioned woman

When a colour-blind man marries a normal woman in their F_1 progeny all children would be normal. However the female will be a carrier for the recessive gene. If that female gets married to a normal male in the F_2 generation normal and colour-blind nature will occur in 3 : 1 ratio.

4.5 Pleiotropy

It is an established fact that a specific gene controls a specific phenotypic trait. This finding is not always true. Studies on 'gene expression' have revealed that a gene often influences more than one phenotypic trait. This phenomenon of multiple effects of a single gene is called **pleiotropism**. In such a genic influence more conspicuous expression of a phenotypic trait by a gene is called its **major effect**. If the gene causes other less conspicuous phenotypic changes, it is known as **secondary effect**. Such genes responsible for multiple effects are called **pleiotropic genes**.

Vestigial wings in *Drosophila* are caused by a recessive gene in homozygous condition. A keen observation has shown that this gene affects other traits as well. They are

- (i) the small halteres or balancers behind the wing
- (ii) structure of reproductive organs
- (iii) egg production
- (iv) life duration and
- (v) bristles on the body.

Self Evaluation

Part-A

1. ABO blood group in man is an example for
 - a) Pleiotropism
 - b) multiple allelism
 - c) x - linked inheritance
 - d) y - linked inheritance
2. Rh. factor in blood was discovered by
 - a) Galton
 - b) Davenport
 - c) Landsteiner and Wiener
 - d) Clarence Mc clung
3. The type of sex determination in moths and butterflies is
 - a) xx - xo type
 - b) xx - xy type
 - c) zo - zz type
 - d) zw - zz type
4. X/A ratio in super females is
 - a) 1.5
 - b) 1.0
 - c) 0.6
 - d) 0.5
5. Holandric genes occur exclusively on
 - a) x - chromosomes
 - b) y - chromosomes
 - c) autosomes
 - d) both x and y chromosomes

Part - B

Give very short answer.

6. What are multiply alleles ?
7. Provide the genotypes for himalayan albino rabbits
8. Mention the possible genotypes of the offsprings if the parental blood groups are B and B.
9. What is the cause for the death of a child in erythroblastosis fetalis?
10. What was the opinion of biometricians in genetics
11. Who are mulattoes?
12. What is Hermaphroditism?
13. What is arrhenotokus parthenogenesis?
14. What are holandric genes.

Part - C

Answer briefly

15. What will be the nature of the F_2 progeny, if a coloured rabbit is crossed with an albino?

16. Discuss how 'O' blood group is considered as an universal donor.
17. What is erythroblastosis fetalis?
18. Write notes on quantitative inheritance.
19. Provide an account on turner's syndrome and klinefelter's syndrome.
20. Describe the process of sex determination in Bonellia

Part - D

Answer in detail

21. Give an account of ABO blood groups in human beings.
22. Explain genic balance mechanism of sex determination.
23. What is sex - linked inheritance ? Give an account of x - linked inheritance in Drosophila.

5. Developmental Biology

The process of sexual reproduction ensures the formation of a diploid zygote which could constitute the next generation. A zygote is a single celled structure. By an ontogenetic process the zygote undergoes various developmental phases resulting in multicellular embryonic organisation. These phases include **cleavage, gastrulation, neurulation, organogenesis** and the period of **growth and histological differentiation**. In spite of the fact that organisms vary in their structure, form and mode of life, the processes of embryogenesis, development and differentiation are remarkably similar in all metazoans. Till later stages of development a fundamental uniform pattern in development can be observed. The ontogenetic stages also reflect the historical development of species or **phylogenetic development**.

Realising the mode of formation of a young individual of the next generation has always interested human mind. There is a recorded history of human natural curiosity in sexual reproduction from very early period. The '**Susruta samhita**', a monumental Indian medical book, written during second or third century A.D., describes the development of a human child in the mother's womb.

The earliest recorded work had been done by Aristotle (384-322 BC). His classical work *De Generatione Animalium* is concerned with the generation of animals. It describes the reproduction and development of many kinds of animals. In his another work "*De Historia Animalium*", Aristotle provides an account of the development of the hen's egg. He compared reproductive methods of different animals and provided a classification based on that. By observing the development of hen's egg he concluded that the development always proceeds from simple formless beginning to the complex organization of the adult. For this speculative idea he provided the name **epigenesis**. Through his remarkable observation and speculations Aristotle established '**embryology**' as an independent field in science. Thus to-day he is regarded as the **founder of the science of embryology**.

After the period of early Greek thinkers this discipline once again got the attention of the scientists from the beginning of the 17th century. Through the contributions made by various workers like **Von Baer, E. Haeckel, O. Hertwig, E.B Wilson, Spemann, C.M Child, Maclean** and others rapid advancements were being made in the understanding of de-

velopmental processes in animals. Modern embryology has utilised all tools made available from other branches of science and diversified into branches such as ‘**Experimental embryology**’, ‘**Chemical embryology**’, ‘**Comparative embryology**’ and **Descriptive embryology**. Such studies have paved the way for meeting the challenges of to-day’s world through works on cloning techniques, tissue culture, stem cell researches, ‘**in vitro**’ fertilisation, organ transplantations, regeneration, tissue grafting and other medical and non-medical fields.

Gametogenesis :

The process of embryonic development in sexually reproducing multicellular organisms is made possible through processes of **gametogenesis** and **fertilization**. Gametogenesis is the formation of **sex cells** or **reproductive cells** or **gametes**. It happens in primary sex organs called **gonads**. The male and female gonads, namely the testis and ovary contain **primordial germ cells**. These cells are responsible for the production of gametes.

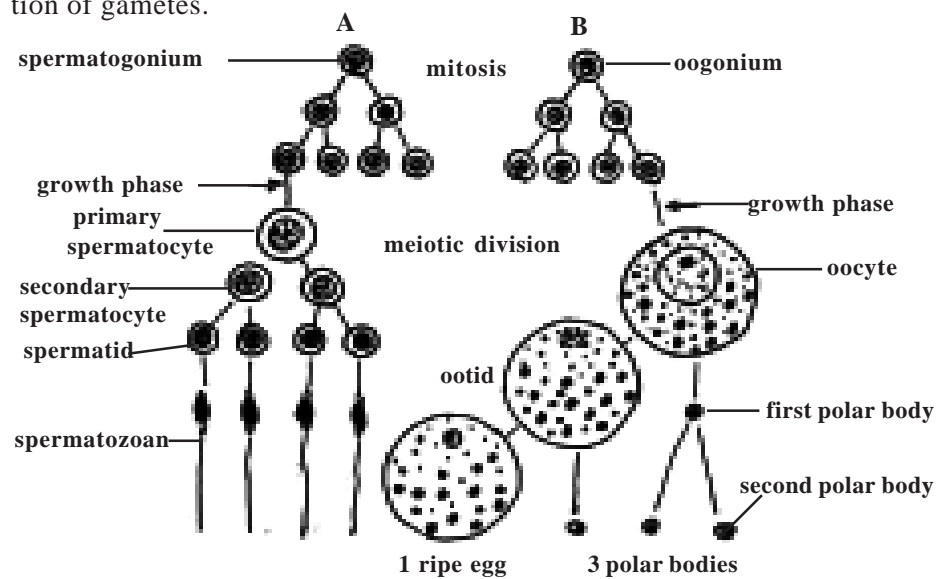

Fig.5.1.1. A-Spermatogenesis - B-Oogenesis

Spermatogenesis :

In the testis of vertebrates the specialised tissue for the process of spermatogenesis are located in the **seminiferous tubules**. The primordial germ cells of these tubules produce cells which ultimately become **sperm**

mother cells or spermatogonia. Through a growth phase the spermatogonia get converted into **primary spermatocytes**. These are diploid cells. They undergo meiotic cell division. Initially the I Meiosis results in the formation of **secondary spermatocytes**. Through II Meiosis they form **spermatids**. The spermatids are haploid in nature. By a process of **spermiogenesis** or **spermioteliiosis** they get differentiated into specialized cells called **spermatozoa**.

Oogenesis :

A similar process happens inside the female gonad, namely the **ovary** for the production of **Ova**. This process that happens in the primordial germ cell of the ovary passes through stages of primary **oogonia**, **primary oocyte** and **secondary oocyte**. These stages are conducted by meiotic cell divisions. Thus the final product, namely the **ovum** is a haploid female reproductive cell.

Fertilization :

Embryogenesis could occur only after the **fertilization** of the ovum or egg. Fertilization provides the diploid nature to the cell. Thus all the somatic cells of the embryo will remain diploid. Further, the process of fertilization triggers or initiates the initial stages of embryogenesis. During the process of fertilization the sperm and ovum of the same species approach and come in contact with each other. The entry of sperm initiates further changes in the egg. The haploid nuclei of the sperm and ovum fuse, resulting in the formation of a diploid zygote nucleus. This process of nuclear fusion is known as **syngamy** or **amphimixis**.

5.1. Types of eggs

For the embryo to develop inside a fertilised egg nutrition is needed. The amount of food needed varies for different organisms. It normally depends on the duration of development. Food is provided in the form of **yolk**. It may be '**fatty yolk**' or **protein yolk**'. It is provided by the ovary during differentiation of the egg. Due to accumulation of yolk a maturing egg rapidly increases in size. In amphibian eggs yolk occurs in the form of large granules, called **yolk platelets**. Chemically, the yolk platelets contain two main proteinaceous substances namely **phosvitin** and **lipovitellin**.

The amount of yolk is an important determining factor for further patterns in embryological stages. The amount of yolk influences cleavage and gastrulation methods.

The eggs can be classified based on amount and distribution of yolk.

Amount of yolk and egg types :

In certain animals the developmental stages are not very elaborate. The final 'young one' born may be very simple in structure and organization. Such conditions remain in animals like *Hydra*, *Sea urchin*, *Amphioxus* and **Placental mammals**. In the eggs of such organisms due to brevity of the growth period the amount of yolk is much reduced. Such eggs are said to be **Microlecithal** or **oligolecithal**.

In certain other animals the eggs need to release young ones in a more self supportive condition. Hence for such eggs the amount of yolk is considerable in quantity. Such eggs with moderate amount of yolk are called **mesolecithal eggs**. Such eggs are produced by annelid worms, molluscs and amphibians.

In some animals the growth and differentiation of the embryo is much more elaborate. The growth period is sufficiently long. Hence for supporting the embryo in development the eggs contain large quantity of yolk. Such eggs are termed as **Megalecithal** or **Macrolecithal eggs**. The eggs of reptiles and birds are considered as macrolecithal. Further these eggs are covered by a calcareous shell. It is a protective structure for laying the eggs on lands. Such eggs are called **cleidoic eggs** or land eggs.

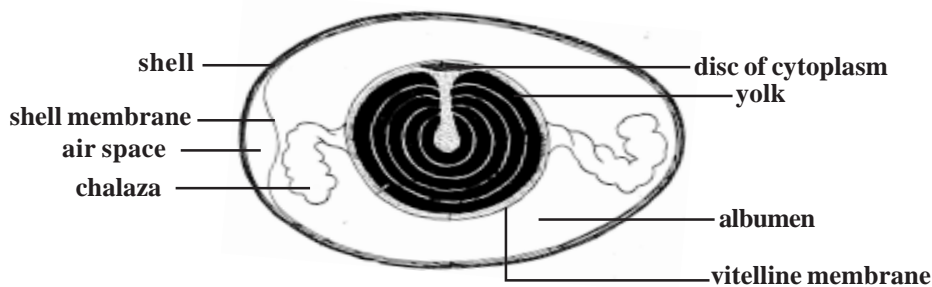

Fig.5.1.2. Hen's egg

Distribution of yolk.

The pattern of cleavage and the consequent gastrulation processes are affected by the distribution of yolk within the egg. According to the pattern of dispersal of yolk the following egg types had been identified.

1. Homolecithal or isolecithal eggs.

Eggs of this type have the yolk disbursed in the entire cytoplasm. The distribution is somewhat uniform in animal, vegetal poles and the equatorial

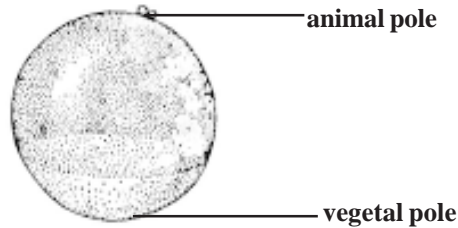

Fig.5.1.3. Isolecithal egg

region. In such eggs the cleavage will be deeper and may bisect the eggs connecting the two poles. All microlecithal eggs have this nature.

2. Telolecithal eggs.

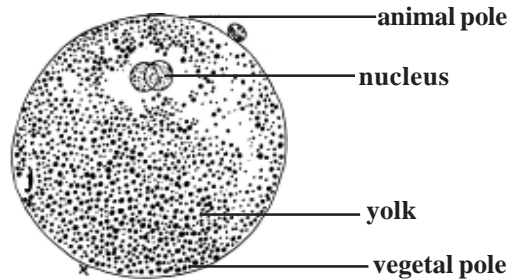

Fig.5.1.4. Telolecithal egg

All eggs have polarity. In polarity, the eggs have an innate nature for to be differentiated into upper animal pole and lower vegetal pole. The polar nature is mainly due to the denser material in the cytoplasm, namely yolk. The yolk in the egg will normally get concentrated in the vegetal pole. The cytoplasm with the nucleus will occupy the upper animal pole. The extent of vegetal pole is determined by the amount of yolk. Thus the eggs having a polarised distribution of yolk in the cytoplasm are referred to as Telolecithal eggs. Mesolecithal and macrolecithal eggs remain as telolecithal eggs.

3. Centrolecithal eggs.

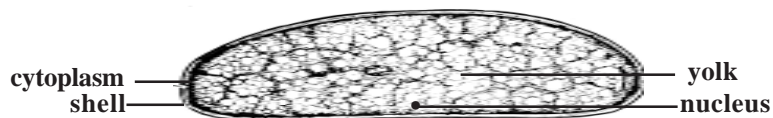

Fig.5.1.5. Centrolecithal egg

An egg need not be spherical always. In invertebrate animals oval shaped eggs are seen. The pattern of cleavage and further gastrulation also deviate from that of the vertebrates. In **insects** the eggs are oval in shape and the yolk remains in the centre of the egg. However, the eggs of echinoderms are similar to that of the vertebrates.

5.2 Cleavage and types - Frog's egg.

The process of cleavage reamains one of the earliest mechanical activity in the conversion of a single celled egg into a multicellular embryo. It is initiated by the sperm during fertilization. However in parthenogenetic eggs cleavage can commence without the influence of fertilization.

The process of cleavage or **cellulation** happens through repeated mitotic divisions. These divisions result in cells called **blastomeres**. In later stages of development the blastomeres occupy different regions and differentiate into several types of body cells.

The first cleavage of frog's egg was observed by **Swammerdam** in 1738. The entire process of cleavage in frog's egg was studied by **Prevost** and **Dumas** in 1824. With the development of microscopes cleavages and further stages were observed in the eggs of sea urchin, star fishes, amphioxus and hen's eggs.

From all these studies it has become clear that all divisions in cleavage are **mitotic**. The mitotic process is very rapid. In the eggs of sea urchin division of the blastomeres can be observed every 30 minutes. As the cleavage progresses the resultant daughter cells, namely the blastomeres get reduced in size. During cleavage there is no growth in the blastomeres. The total size and volume of the embryo remains the same. The cleavages result in a compact mass of blastomeres called **morula**. It gets transformed into **blastula**. While the wall of the blastula is called the **blastoderm**, the central cavity is called the **blastocoel**.

The planes of cleavage

An egg can be divided from different planes during cleavage. Depending on the position of the cleavage furrow the planes of cleavage are named.

1. **Meridional cleavage**: The plane of cleavage lies on the animal vegetal axis. It bisects both the poles of the egg. Thus the egg is divided into two equal halves.

2. **Vertical cleavage:** The cleavage furrows may lie on either side of the meridional plane. The furrows pass from animal to vegetal pole. The cleaved cells may be unequal in size.

3. **Equatorial cleavage:** This cleavage plane bisects the egg at right angles to the main axis. It lies on the equatorial plane. It divides the egg into two halves.

4. **Latitudinal cleavage:** It is similar to the equatorial plane, but it lies on either side of the equator. It is also called as **transverse** or **horizontal cleavage**.

Influence of yolk on cleavage

Yolk is needed for embryonic development. However the fertilized egg has to undergo all stages of development and result in a suitable 'young form' initiating next generation. Somehow with all the influences of yolk the developmental procedures are so adapted and modified that a well formed embryo will result. The initial influence of yolk is felt during the process of cleavage.

The amount of the yolk and its distribution affect the process of cleavage. Accordingly several cleavage patterns have been recognised.

1. **Total or holoblastic cleavage** - In this type the cleavage furrow bisects the entire egg. Such a cleavage may be either equal or unequal.

(a) **Equal holoblastic cleavage** - In microlecithal and isolecithal eggs, cleavage leads to the formation of blastomeres of equal size. Eg: Amphioxus and placental mammals.

(b) **Unequal holoblastic cleavage** - In mesolecithal and telolecithal eggs, cleavage leads to the formation of blastomeres of unequal size. Among the blastomeres there are many small sized micromeres and a few large sized macromeres.

2. **Meroblastic cleavage** - In this type the cleavage furrows are restricted to the active cytoplasm found either in the animal pole (macrolecithal egg) or superficially surrounding the egg (centrolecithal egg). Meroblastic cleavage may be of two types.

(a) **Discoidal cleavage** - Since the macrolecithal eggs contain plenty of yolk, the cytoplasm is restricted to the narrow region in the animal pole. Hence cleavage furrows can be formed only in the disc-like animal pole region. Such a cleavage is called **discoidal meroblastic cleavage**. Eg: birds and reptiles.

(b) **Superficial cleavage** - In centrolecithal eggs, the cleavage is restricted to the peripheral cytoplasm of the egg. Eg: insects.

Laws of cleavage

Apparently there are several cleavage patterns. However, all cleavages follow a common procedure. The cleavages are governed by certain basic principles or laws.

1. **Sach's laws** - These laws were proposed by Sach in 1877.

i) Cells tend to divide into equal daughter cells

ii) Each new division plane tends to intersect the preceding plane at right angles.

2. **Balfour's law** (Balfour 1885) - "The speed or rate of cleavage in any region of egg is inversely proportional to the amount of yolk it contains".

Cleavage of fertilized egg in Frog.

In frog's egg the cleavage is holoblastic and unequal. The cleavage occurs as follows.

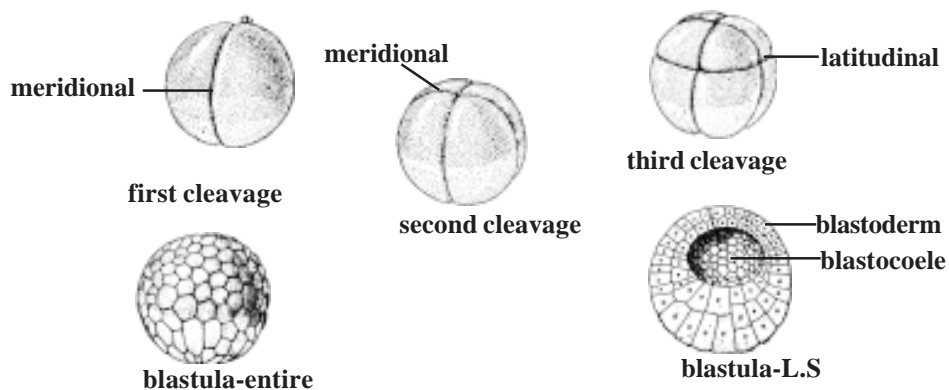

Fig.5.2.1. Cleavage in frog's egg

1. The first cleavage plane is **meridional**. Initially, a furrow appears at the animal pole. It gradually extends towards the vegetal pole of the egg. It cuts the egg through its median animal-vegetal polar axis and results in two equal-sized blastomeres.

2. The second cleavage furrow is again **meridional**. It bisects the first cleavage furrow at right angles. It is a holoblastic cleavage affecting both the blastomeres of the first cleavage. It results in the formation of four blastomeres.

3. In the next stage a **latitudinal** furrow is formed above the horizontal furrow nearer to the animal pole. Such a furrow is due to the influence of yolk concentration in the vegetal pole. The latitudinal furrow uniformly affects all the blastomeres. It results in the formation of eight blastomeres. Four of them remaining in the vegetal pole are large. They are named as **macromeres**. Another four blastomeres remain in the vegetal pole. They are named as **micromeres**. The micromeres are smaller in size than the macromeres.

4. The fourth set of cleavage planes are **meridional** and holoblastic. They are unequal. They divide yolkless micromeres more rapidly than yolk-rich macromeres. These cleavages result in the production of 16 blastomeres.

5. As a result of further cleavages, a ball of several small blastomeres result. A closer observation reveals that, while the blastomeres above the equator are small and remain as micromeres, the blastomeres of the vegetal pole remain progressively larger. The larger blastomeres are called the macromeres.

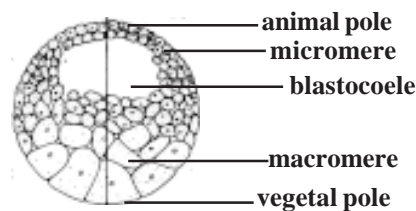

Fig.5.2.2. L.S of Frog blastula

At the final stages of cleavage the embryo acquires a characteristic, mild, oblong shape. In this stage it is called the **morula**. The morula initially contains a shallow cavity called the **blastocoele**. Gradually the blastocoealic space increases into a large cavity occupying the middle of the blastula. However the blastocoele mostly remains in the animal pole region in the middle of the micromeres.

The blastomeres gradually adhere to each other, and arrange themselves into a true epithelium called the **blastoderm**. The blastoderm remains two cell thick in the animal pole. The embryo having a fluid-filled blastocoele and blastoderm is called the **blastula**.

It has been reported that around 12th cleavage the blastula possesses about 4096 cells. The blastula moves to the next stage, namely gastrulation at a stage in which it has about 20,000 cells.

The ultimate blastula is a ball of blastomeres which have to form different embryonic body layers and organs of the body. The fate of each and every blastomere has been observed and marked. A map showing various

organ forming, areas on the blastula is called the '**fate map**'. This map shows prospective ectoderm, mesoderm and endodermal areas. It also shows the '**zone of involution**' and '**zone of invagination**' for the next stage of gastrulation.

5.3. Gastrulation in frog embryo

The process of gastrulation is a continuous activity succeeding, cleavage. During this process the blastodermal cells begin to move. They wander and occupy their prospective organ forming zones. During this movement at one region on the blastula, the cells wander inside and occupy the blastocoelic cavity.

At a specific region below the equator the blastoderm cells assume an elongated bottle like shape. They move toward the interior of the blastula. As the cells move further inside, an invagination happens. A deepening of the invagination results in a cavity called the **archenteron** or **gastrocoel**. The opening of the archenteron on the surface of the blastula is called the **blastopore**.

The blastopore gradually assumes a crescentic shape. Finally it becomes circular. The region dorsal to the blastoporal opening is called the '**dorsal lip**'. The lower edge may be called the '**ventral lip**'.

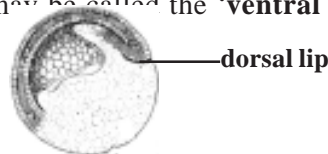

Fig.5.3.1. Formation of dorsal lip

The surface cells representing several prospective zones of the embryo begin to wander inside through the **blastopore**. This inward movement of cells is termed as **involution**.

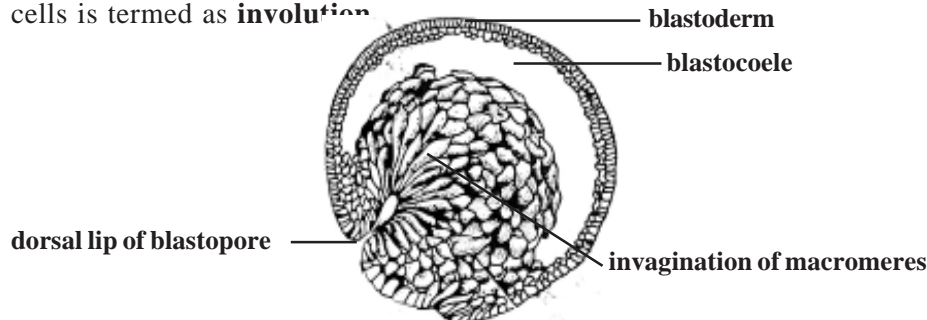

Fig.5.3.2. Invagination of Endodermal cells

Initially, the first pharyngeal endodermal cells undergo invagination over the dorsal blastoporal lip. These cells move to the interior. They are followed by other cells. The inwandering cells gradually occupy the region of the blastocoel. Thus the blastocoelic cavity gets reduced. A new cavity among the involuted cells results. It is called the **gastrocoel**. The gastrocoel later becomes the **archenteron**. The interior region of the archenteron gradually transforms into the pharyngeal region. This region remains as the foregut. The mesodermal and endodermal cells gradually occupy their positions.

The inward movement of the exterior cells through the blastoporal region is called **involution**. The involution results in the positioning of chordamesodermal cells and pharyngeal endodermal cells.

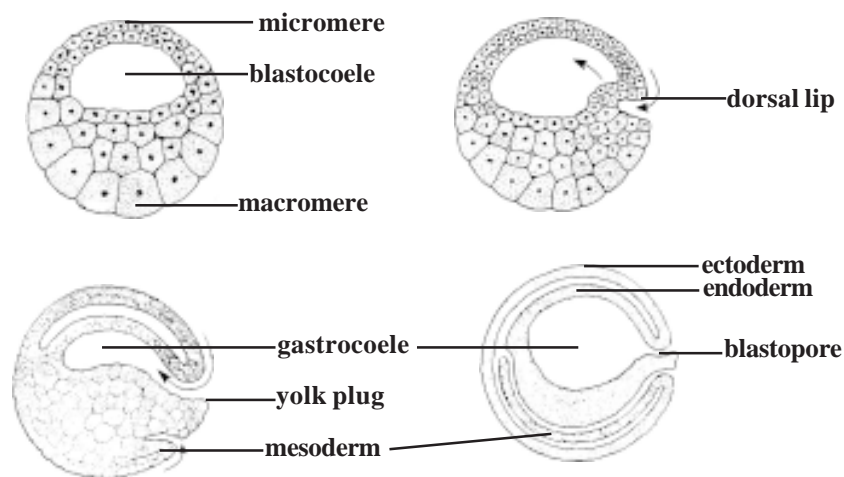

Fig.5.3.3. Gastrulation of Frog

The mesodermal cells occupy the region between inner endodermal and outer ectodermal cells. While the exterior chorda-mesodermal cell involute inside, their place is taken up by the ectoderm. The expansion of the ectoderm is due to **epiboly**. Epiboly causes overlapping or '*the roofing over*' of the gastrula by the ectoderm.

The blastopore is gradually covered by certain endoderm cells. The closing cells of the blastopore constitute the **yolk-plug**. Gradually the yolk-plug withdraws to the interior and the blastopore gets reduced into a narrow slit.

The process of gastrulation converts the blastula into a spherical, bilaterally symmetrical, triploblastic gastrula. Gradually the gastrula undergoes the process of **tubulation** or **neurulation** to become a **neurula**.

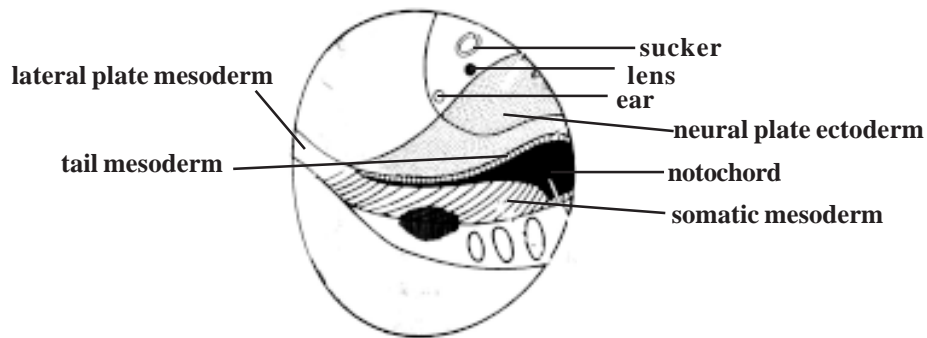

Fig.5.3.4. Fate map of frog blastula

Neurulation

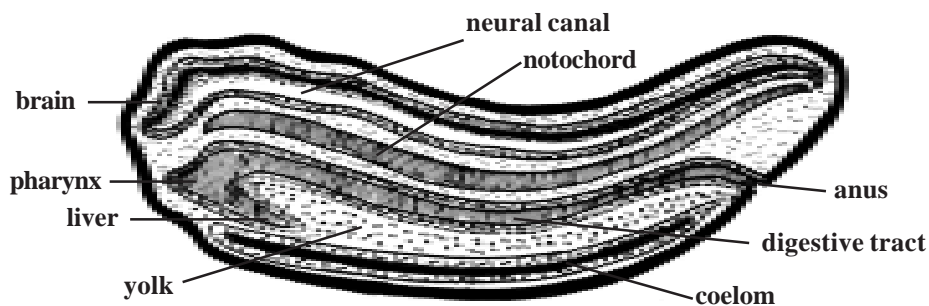

Fig.5.3.5. Neurula of frog

The process of neurulation is the formation of a neural tube. However during this process mesoderm and endoderm also undergo differentiation.

During neurulation the embryo lengthens along the anteroposterior axis. The dorsal side of the gastrula is lined by ectodermal cells. The presumptive area of the nervous system gets differentiated from the rest of ectoderm. It remains as **medullary plate** or **neural plate**. The neural plate later thickens and it gets raised above the general level as ridges called **neural folds**. In the middle of the neural fold a neural groove appears. The **neural groove** deepens inside. The neural folds above the groove. The neural groove gets converted into a **neural tube**. This tube gets detached from the surface. The neural tube remains as the prospective nervous system. The embryo at this stage is called the **neurula**.

During neurulation, the tubulation of chorda-mesoderm and tubulation of endoderm also happen.

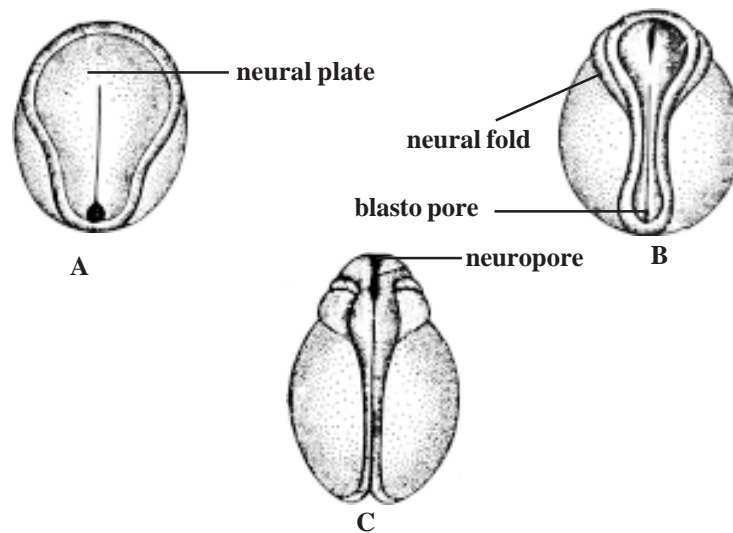

Fig.5.3.6. Neurulation of frog embryo

The post-neurular development of frog involves the formation of all body organs.

5.4. Organogenesis of Frog

The primary organ rudiments from ectoderm, mesoderm and endoderm get well established during the processes of gastrulation and neurulation. In the next stage the primary organ rudiments subdivide into **secondary organ rudiments**. These rudiments get differentiated into various organs and organ systems.

The development of ectodermal organs

The neurula of frog has three kinds of ectodermal tissues namely, epidermal ectoderm, neural ectoderm and neural crest cells.

Epidermal ectoderm

The epidermal derivatives are the skin, olfactory sense organs, ear, lateral line sense organs, median fins, external gills and lining of mouth and anus.

Neural ectoderm

This layer of cells form the central nervous system and peripheral nervous systems.

The development of mesodermal organs

The mesodermal derivatives are the limbs, endoskeleton, heart, blood vessels, kidney, coelom and reproductive organs.

The development of endodermal organs

The predominant endodermal organs are the organs of the alimentary canal, lungs, pancreas and urinary bladder.

Development of heart in Frog

The heart is a mesodermal derivative. It develops on the ventral side of pharynx. It is formed from the lateral plate mesoderm. Initially the heart is formed as a straight tube. Later it gets folded to form the chambered heart.

Self Evaluation

Part - A

Choose the right answer

1. The process of spermiogenesis involves
 - a) production of sperms
 - b) differentiation of spermatids into spermatozoa
 - c) formation of testis
 - d) differentiation of nucleus
2. Centrolecithal eggs are produced by
 - a) frog
 - b) human beings
 - c) reptiles
 - d) insects
3. Discoidal cleavage is seen in the eggs of
 - a) birds
 - b) amphibians
 - c) insects
 - d) amphioxus
4. Sach's law is related to
 - a) gametogenesis
 - b) cleavage
 - c) gastrulation
 - d) organogenesis

5. The cavity formed in a gastrula is called as
- a) gastrocoel
 - b) blastocoel
 - c) blastopore
 - d) cavity

Part - B

Give very short answer

1. Provide a list of various stages in the embryology of animals
2. Why do we consider aristotle as the founder of the science of embryology.
3. What are the several diversified fields formed from modern embryology.
4. What are microlecithal eggs?
5. What is a morula?
6. Define meridional cleavage.
7. Mention Balfour's law regarding cleavage
8. What is a 'fate map' ?
9. What is involution ?

Part - C

Answer briefly

1. Give an account of the megalecithal egg.
2. What is a centrolecithal egg.
3. Provide a general account on cleavage.
4. What is sach's law?
5. What are the ectodermal and endodermal derivatives in the organogenesis of frog embryo

Part -D

Answer in detail

1. Provide a detailed account on the types of eggs.
2. Give an account on the cleavage of fertilized egg.
3. Describe how the process of gastrulation occurs in the egg of an amphibian
4. Describe the structural organisation in the neurula of frog.

6. ECONOMIC ZOOLOGY

Since time immemorial, human beings have used animals for food and other purposes. While some animals are very useful to mankind certain others cause loss to the economy of man. Though every organisms has its own importance in nature, some of them such as a few mammals, birds, fishes, prawns and insects have become valuable. Some pests are competitors of human beings for natural resources and food. Thus a study of economically important animals will always be useful.

6. 1. Beneficial animals

The animals contributing to our economy and welfare are known as **beneficial animals**. Many animals provide us with nutritious food like **meat** and **milk**, clothing materials like **silk** and **wool** and the luxurious items like **pearls** and **corals**. The silk worms, the honey bees, the lac insects, fowls, fishes, prawns and crabs belong to this category.

6. 1. 1 Corals - reef builders

Most of us know about corals and are not familiar with their biology. **Coral rocks** are actually the skeletal remains, primarily of calcium carbonate secreted by living coral polyps. The coral organisms belong to the phylum : **Coelenterata**.

All reef building corals live as large colonies. Reef corals are typically shy, nocturnal feeders. During the day, polyps are withdrawn into skeletal cups and the corals appear more or less lifeless. But at night time the whole reef magically comes to life and coral polyps stretch out their tentacles, probing the waters for food. The reef looks like a field of flowers.

Reef forming corals grow only in shallow, tropical seas where the temperature of the water never falls below 20° c. Only in warmer waters, the coral polyps can extract calcium from the sea water and deposit it as calcium carbonate in their skeletons. Corals thrive only in crystal clear water.

Small plants like **Zooxanthella** living in the coral tissue contribute to the yellow, brown and green colours of some reef forming corals. The brighter red and orange colours are created by pigment cells in the body wall.

Formation of coral reefs

Corals are best known for the massive rocky reefs they build in tropics. The corals spread by producing vast number of minute ciliated larvae called **Planulae**, through sexual reproduction. These larvae initially lead a free swimming life. Later they settle on rocks and start new colonies of polyps by repeated fission or budding. A coral reef is thus a result of the activity of millions of coral polyps over several thousand years.

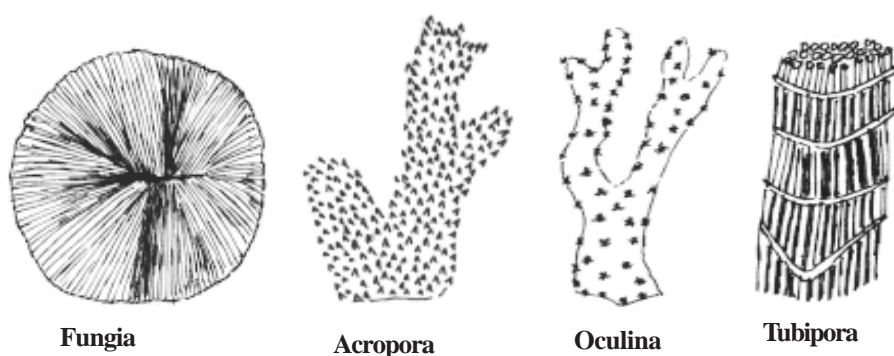

Fig.6.1.1. Corals

Coral reefs are of three types namely, **Fringing reefs**, **Barrier reefs** and **Atolls**. In India coral reefs occur in the Lakshadweep, Andaman and Nicobar Islands and in the south east-coast.

Fringing reefs form shallow shelves in shallow waters at or near the shore of the mainland or around offshore Islands. At the southern end of Indian peninsula, this type is seen as a chain of well developed reefs starting from Rameshwaram Island and extending beyond Tuticorin. They are also present in the Gulf of Kutch on the west coast of India.

Barrier Reefs are situated away from the coast and form off-shore break waters parallel to the coasts or isolated islands. The famous **Great Barrier reef** of North Eastern Australia which is 2012 kilometres long, is the largest of its kind.

Atolls consist of a ring shaped reef, encircling a shallow lagoon which is connected to the outside by an opening. Hawaii and Carribbean Islands are famous for Atolls.

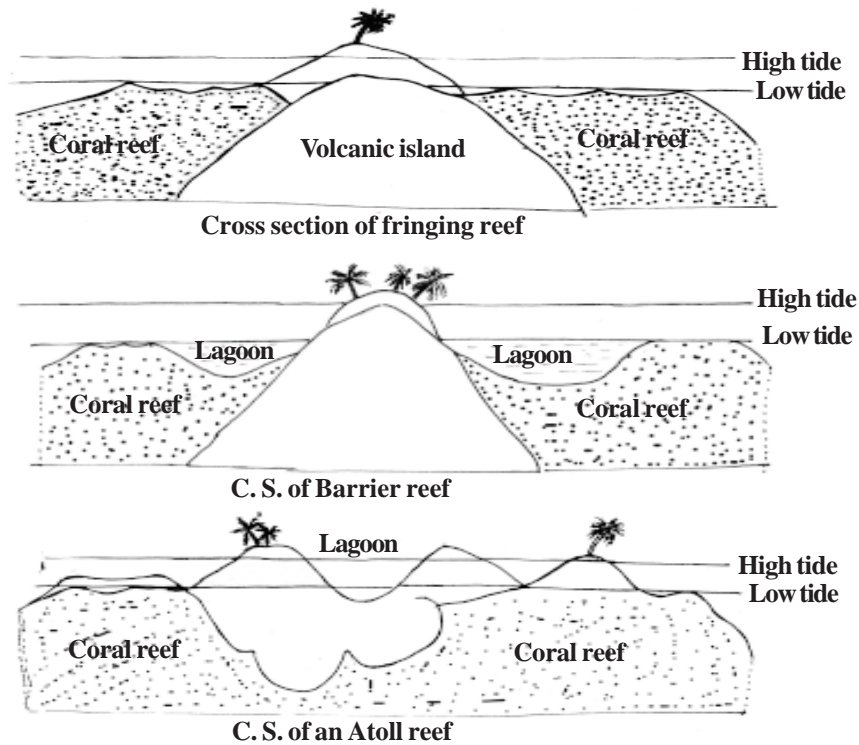

Fig.6.1.2. Coral reef - Types

Economic importance

Some corals are highly priced for their decorative value. Precious corals like *Corallium nobile* (= *C. rubrum*) are used in jewellery and ornaments. Corals are also important in building the coral reefs and islands, some of which are used as habitation by human and other animals. The **organ pipe coral** (*Tubipora*) is used in indigenous system of medicine in South India.

Coral skeletons especially of species like porites are used in as building construction and for metalling their roads. Corals serve as raw materials for the preparation of lime mortar and cement because of their calcium carbonate content. Some older coral lime stones are rich in magnesium, hence they are of great value in making cement. Coral skeletons act as natural barriers against sea erosion and cyclonic storms. Old reefs have long served as sea bird sanctuaries and have collected huge deposits of bird droppings (guano).

Coral reefs provide a unique habitat for large and diverse variety of organisms. The richness of the invertebrate fauna and the complex structure of the coral reefs have provided opportunities for the evolution of a number of fishes associated with coral reefs.

In several countries Fringing reef, Barrier reef and Atolls are helping in the tourism industry.

6. 1. 2 Earthworm - Vermiculture

The growth of industries, urban cities and the ever increasing human population have led to an increased accumulation of waste materials. Waste materials introduced into the environment are of two types namely non-degradable and degradable wastes. The disposal of these solid wastes remains serious challenge in most of the countries.

Waste biomass from agriculture, domestic, urban and industrial sources remains the main cause of organic pollution in many countries, including India. Degradable or decomposable materials constitute a major percentage of the refuse (more than 60%).

New technologies are now available for recycling some of these solid wastes. These wastes can be utilized in vermiculture for the production of earthworm casts and earthworm tissue protein.

India produces about 2500 million tonnes of organic wastes annually. If properly managed about 400 million tonnes of plant nutrients can be produced from this huge organic wastes.

Vermiculture :-

In recent years vermiculture has received much attention in many countries. The spiralling cost of fish meal and the low supply of soyabean meal are responsible for the utilization of earthworms as an alternative low cost protein meal in aquaculture and poultry industry. Further the worms also play an important role in waste disposal. They decompose natural organic wastes into rich compost fertilizer. A single earthworm can produce 1000 to 1500 offsprings in a year. 2000 mature breeders can produce more than 1 million worms in a year.

Selection of earthworm species and their culture

Lampito mauritii and *Perionyx excavator* are cultured in India and Thailand. *Helodrilus foetidus* and *Lumbricus rubellus* are distributed world

wide. *Amyntas hawayana*, *Eisenia foetida* and *Eudrilus engeniae* are also commonly used for waste management.

The methods of culturing earthworms can vary from place to place. A cultured worm must be able to adapt to substrates, grow fast and breed or multiply readily under controlled conditions.

A compost pile bed of 2.4m long, 1.2m wide and 0.6m deep appears to be very satisfactory for a population of more than 50,000 earthworms. The boxes can be made from wood (51cm long, 36cm wide and 15 cm deep) to accommodate 5000 to 6000 worms. Soil, organic matter, manure, leaves, rice straw, dried water hyacinth, saw dust and any fermented substrate can be used as a culture medium to raise worms in boxes or containers.

The worms in the worm beds can grow and reproduce faster if they are given sufficient food. Any decayed organic matter appears to be good food for worms but the feed should not be contaminated by detergents or insecticides.

Since the earthworms are rich in protein (65%), fat(14 %), carbohydrate (14 %) and ash (3%) they are used as a feed component for fish, prawn and shrimp. They are also used as livestock feed in poultry industry.

Vermicompost

Many species of earthworms are easily adaptable to agricultural wastes like after harvest strubble, sugarcane thrash, coirwaste, dung of cow, horse, sheep and poultry droppings. The breakdown of these materials or the degrades of organic matter by worm activity is called '**Vermicompost**' It is a better source of organic manure.

6. 1. 3 Beneficial Insects

Insects affect man's welfare in many ways. Many insects are beneficial to man. **Beneficial insects** are divided into two main groups according to the nature of benefit derived from them. They are **Productive** and **Helpful insects**.

I. Productive Insects

These insects produce certain substances which are useful to humans. The important useful insect products are **Honey**, **Silk** and **Lac**.

A. Honey bee

Honey bees are social insects. They live as colonies. They are active throughout the year. They feed on the pollen and nectar of flowers. In India there are four different varieties of honey bees. Of these, only three species are useful in collecting honey.

1. *Apis dorsata* (Rock bee). This is the largest of the Indian honey bees. It produces plenty of honey. It builds large open single combs which may often be four feet long on tall forest trees. It is not possible to domesticate them for the bee keeping industry.

2. *Apis florea* : This is the smallest of the three species and is known as the little bee. It builds single combs, which are very small. They are found hanging from bushes and corners of roof.

3. *Apis indica* : This is the common Indian honey bee. Its size is intermediate between *A. dorsata* and *A. florea*. This bee builds several parallel combs, generally in hollows of trees, on the walls, inside wells, caves and similar protected spots. This is the only Indian honey bee capable of domestication.

The honeybees collect **nectar** from various flowers. The nectar is swallowed by the bees. In its stomach due to the action of enzymes certain changes happen to the nectar. Later in the bee hive it is regurgitated and stored in chambers as **honey**.

Apiculture or Bee keeping is the technique of rearing honey bees for honey and wax from their comb or beehives.

Uses of Honey and Bees wax

Honey has a high nutritive value. Its colour and smell varies in accordance with the nectar collected from different flowers.

It is estimated that 200g of honey provides as much nourishment as 11.5 litres of milk or 1.6kg cream or 330g meat. One gram of honey provides approximately 33k.cal of energy. Honey has laxative, antiseptic and sedative characteristics. It is used in Ayurvedic and Unani systems of medicines. It is helpful in building up the haemoglobin of the blood. It prevents cough, cold, and fever. It cures ulcers on tongue and alimentary canal. It is also used in the preparation of bread, cakes and biscuits.

Beeswax is also a natural secretion of the worker bee from the glands located in the abdomen. It is used in the manufacture of cosmetics, face creams,

paints, ointments, insulators, plastic works, polishes, carbon paper and many other lubricants. It is also used in microtomy for block preparation of tissues.

B. Silk worms



Adult male



Adult female

Fig. 6.1.3. Silkworm

Silk is another valuable product from the insect world. The silk is obtained as fine threads from the cocoons of various species of silkworms. **Sericulture** is the scientific management of production and marketing of natural silk from silkworms.

Types of Silk worms

1. **Mulberry silkworm - *Bombyx mori*** : This is a completely domesticated insect. Since the natural food of this worm is mulberry leaves, it is called mulberry silk worm. The silk produced by this moth is white in colour. It is called the mulberry silk.

2. **Tasar Silk worm : *Antheraea paphia***

This caterpillar feeds on ber, oak, sal and fig plants. The cocoon produced by this worm is smooth and hard. It is of hen's egg size. The cocoon yields reelable, brown coloured Tasar silk.

3. **Muga Silk worm: *Antheraea assamensis***: The native place of this species is Assam where it has now become a good source of cottage industry. The silk produced by this moth is known as **Muga silk**.

4. **Eri Silk worm : *Attacus ricinii***

The caterpillar of this worm feeds on castor leaves. The cocoons of this worm have very loose texture and the silk produced is called as **Arandi silk** locally. The threads are not glossy but much durable.

The sericulture plays a significant role in the rural economy of our country. The Chinese have the credit of discovering silk. It was kept as a

secret for several centuries. India now occupies a unique position in the world for its rich sericigenous fauna to produce pure mulberry silk as well as the three other varieties of non-mulberry silks.

Uses of silk

The raw silk is used in the manufacture of woven materials, knitted fabrics and garments. It is also used in parachutes, parachute cords, fishing lines, as sieves in flour mills, insulation coil for telephones and wireless receivers, and tyres of racing cars.

C. Lac insects

Another useful product we get from insects is **lac**. Lac is the resinous protective secretion produced by a kind of scale insect called *Laccifer lacca*. They secrete a brown resinous substance called the **lac**. The minute red coloured larva of this insect, settles on succulent shoots of the host plants. While growing they secrete a resinous material which covers them. The twigs are harvested and the encrustations scraped, dried and processed to yield the lac of commerce.

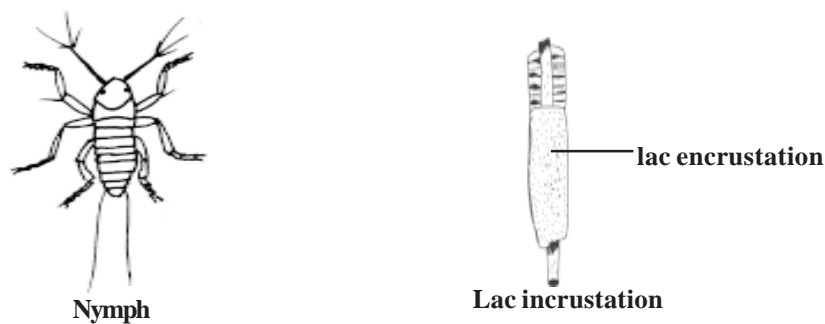

Fig. 6.1.4. Lac insect

The important trees needed for lac encrustation are the kusum, the Ber, Palas, Babul and sal. These trees are common in the western ghats.

Uses of lac

Lac is one of the most versatile natural resinous material. It has a unique combination of properties which render it useful in the plastics, electrical, adhesive, leather, wood finishing and other industries. In the electrical industry it used in the form of insulating varnishes and moulded insulators. It possesses very good adhesion to mica. It is an ingredient of varnishes, polishes, finishes wood used for protective and decorative purposes. It

is a principal ingredient of sealing wax. It is also used in the manufacture of glazed paper, printing and water proof inks, nail polishes, dental plates, ammunition, bangles, wax crayons and optical frames.

II. Helpful Insects

This category of insects includes all forms which by their life activities help man in controlling the plant and animal pests. The most important of these helpful insects are the **insect feeding or entomophagous** forms including predators and parasites. These are important in maintaining a balance in insect populations.

Insect - Predators

These are generally larger than their prey. They can pounce upon and devour the prey easily. Among the insect predators, **lady bird beetles** are more useful to the farmers and gardeners. These small beetles are voracious and are highly prolific and long-lived. Both larvae and adults feed on a wide range of insects. Other common and well known predators are **Aphis lions** and **ground beetles**.

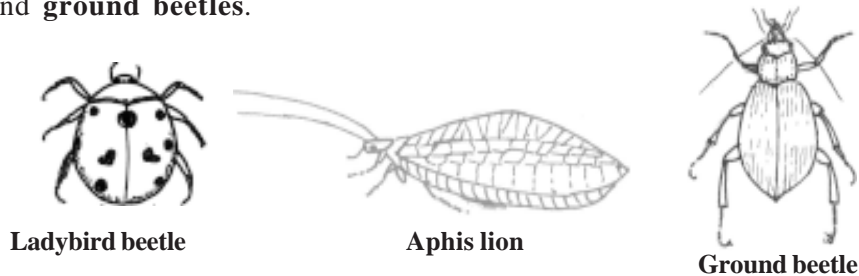

Fig. 6.1.5. Insect - predators

Insect parasites

Insect parasites are smaller than their hosts. They live continuously for atleast a part of their lifecycle on or within the body of the host. The **tachinid flies** parasitize caterpillars, beetles and other groups of insects. The **braconids** are a large group of small wasp-like insects that parasitize a wide range of insects including plant lice and caterpillars. Most group of insects are plagued by **ichneumon** parasites.

Employing insect **predators** and **parasites** for controlling the population of insect pests is known as **biological control**.

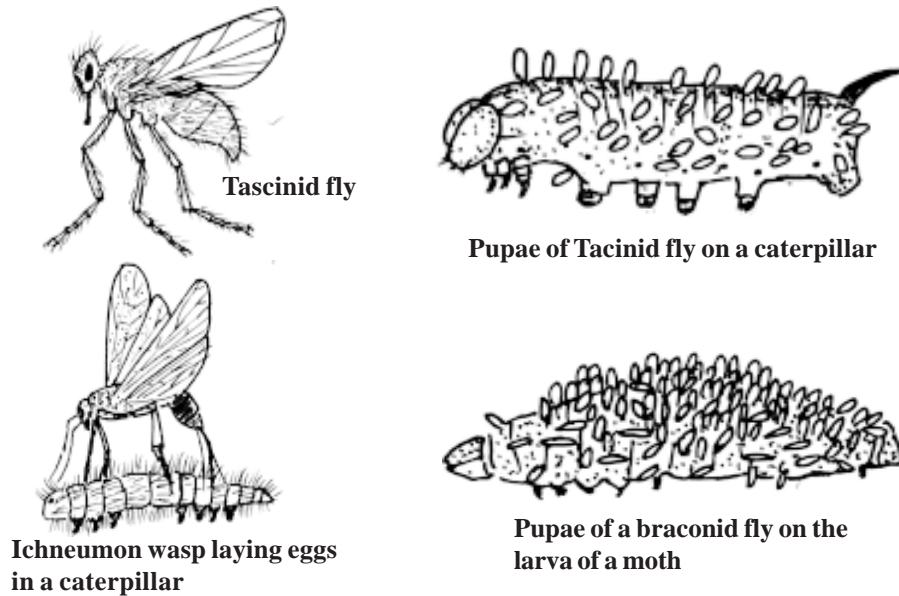

Fig. 6.1.6. Insect parasites

Insects as pollinators

Insects play an important role in the pollination of plants. Bees, wasps, ants, butterflies, beetles and thrips render valuable service in pollination. The services of honey bees are needed in the production of cultivated crops, such as apples, pears, plums and vegetables. Some plants like the yucca and smyrna fig are completely dependent upon insects for pollination.

Other useful insects

A number of insects feed on plants and they may aid in keeping plant weeds under control. The most successful use of an insect in the control of a plant was the introduction of the caterpillar of a moth (*cactoblastis cactorum*) to control the prickly pear (*Opuntia* spp) in Australia.

6. 1. 4 Prawns, Lobsters and Crabs

A. Prawns

The prawns are one of the most economically important fishery organism of India. It helps to earn a sizeable amount of foreign exchange. The prawns are the most esteemed food among the marine food organisms. Therefore, they are in great demand both in the local and international markets.

Export of 'prawn pulp' to Burma and Malaya from earlier times and 'frozen and canned' prawns to USA and Japan in recent years has made Indian prawns a major foreign-exchange earner. Apart from being a delicacy, prawns are a rich source of protein and vitamins (A and D). They contain considerable quantities of glycogen and free aminoacids in their muscles imparting their flesh a sweet taste. As they contain very little fat, they have become a favourite protein food for the weight conscious persons.

Indian prawns of commercial importance

Penaeus indicus, *P. monodon*, *P. japonicus*, *Metapenaeus dobsoni*, *M. monoceros*, *M. affinis*, *M. brevicornis*, *Parapenaeopsis stylifera*, *P. sculptilis*, *Macrobrachium rosenbergii*, *M. malcomsonii*, *Palaeomon tenuipes* and *P. styliferus*



Fig. 6.1.7. Prawns

Freshwater prawns inhabit rivers and lakes across the entire country. They migrate to brackish water for breeding. Eg. *Macrobrachium*, *Palaeomon*. Marine prawns occur in shallow coastal waters. They form large shoals close to malabar coast during the monsoon season. *Penaeus*, *Parapenaeopsis* and *Meta penaeus* are the important genera of the Indian coast. The practice of rearing prawns as a 'secondary crop' between November and April in the paddy fields along the coastal areas in India should be a step towards increased production of fresh water prawns.

Fresh prawns are packed in ice and sent to inland markets for consumption. Large specimens are frozen directly between layers of ice. Smaller varieties are boiled, shelled and then packed between ice. Prawns are also cured. This includes sundrying, salting and pickling.

B. Lobsters

Lobsters belong to four main groups. They are clawed or **true lobsters**, spiny or **rock lobsters**, sand or **slipper lobsters** and **coral lobsters**. The lobsters of our country are called spiny lobsters. The economically important species of spiny lobsters are *Palinurus polyphagus*, *P. homarus*, *P. ornatus* and *P. versicolors*. The lobsters are called 'கல் இரால்' (Kal Eral) in Tamil.

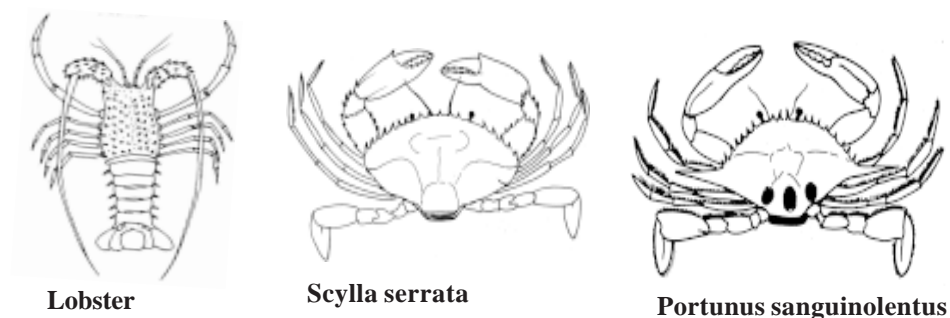

Fig. 6.1.8. Lobsters and crabs

The lobster fishery of India gained importance only recently. Its food value (proteins 15-24 %) was realised following the demand for lobsters in western countries. India is one of the prominent countries in spiny lobster marketing. The main lobster landing centres in India are Mumbai, Veraval, Kolachal, Tuticorin, Chennai, Mandapam and Kozhikode. North west coast contributes 80-90 percent of the landings with *P. polyphagus* being the dominant species. On the west coast *P. polyphagus* and *P. homarus* are very common and on the east coast *P. polyphagus* and *P. ornatus* are common. In the Gulf of Mannar the lobster fishery is confined to the areas where coral reefs are present. The lobsters are caught throughout the year but the peak fishing season is December to January.

The lobsters are esteemed as good food particularly in foreign countries. Therefore most of the lobster catches are exported to USA, Canada, UK, France, Spain, Belgium, Gulf countries, Nepal and Singapore.

The central Marine fisheries Research Institute (CMFRI) has carried out studies on fishery, recruitment, biology, physiology, breeding, larval rearing and culture of economically important spiny lobsters in India.

C. The Crabs

The crabs are decapod crustaceans. They are characterised by the greatly enlarged cephalothorax. The abdomen in crabs shows sexual dimorphism. In males the abdomen is narrow. In female crab the abdomen is broad, and it carries eggs during breeding season.

There are nearly six hundred crab species occurring in the Indian waters but only very few of them are being used for food purposes. The important species of crabs supporting the fishery are *Matuta lunaris*, *Scylla serrata*, *Portunus sanguinolentus*, and *Charybdis cruciata*.

6. 1. 5 Pearl Oyster

Pearls are one of the rarest and highly esteemed gems. Pearls are produced by the pearl **oysters** of the genus *Pinctada* under class Bivalvia. From the point of view of pearl production in Indian waters, the most important species is *P.fucata*. It has a wide distribution in the Persian Gulf, Red sea, Gulf of Kutch, Gulf of Mannar and the Palk Bay. The oysters occur on ridges of rock or dead coral in the Gulf of Mannar along both coasts of India and Sri Lanka. These formations are known as 'pearl banks' or 'paars'. They extend from Cape comorin to Rameshwaram Island. Heavy production had been recorded in Tuticorin.



Fig. 6.1.9. Pearl Oyster

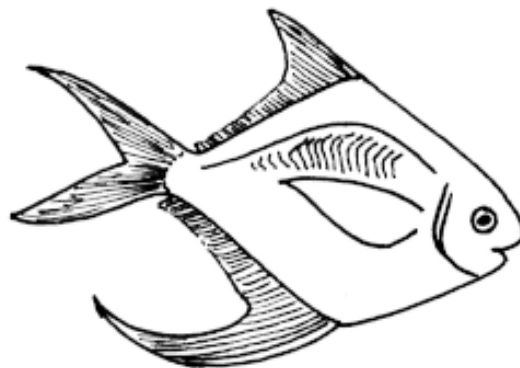

Fig. 6.1.10. Pomfret

From each pearl oyster bed thousands of oysters are taken out. Every oyster contains a pearl. Most of the pearls obtained are too small. Some of them are large, perfectly round with fine lustre fetching high prices. Hence it is worthwhile farming oysters and induce pearl formation. In recent years India has succeeded in developing farming techniques for the production of cultured pearls of good shape and lustre.

The CMFRI in India gives necessary training in pearl culture techniques. In this process shell beads are introduced into the soft tissues of the oyster along with a strip of the mantle so that the latter may secrete the pearly substance around the bead. The treated oysters are well taken care of in cages suspended from floating rafts in shallow waters of the sea. Thus, cultured pearls are produced in the same way as the natural pearls. The pearl is a concretion of calcium carbonate in an organic matrix. It is like the nacreous layer secreted by the mantle on the inner surface of the shell valve.

Shells having a brilliant silvery sheen are known in commerce as the “mother of pearl”. They are collected for the manufacture of buttons and other fancy articles.

6. 1. 6 Fishes - Nutritive value

The marine fisheries of India are of importance in increasing the country's food resources and fetching a considerable amount of foreign exchange through the export of frozen and processed marine products. Besides, the major capture fisheries, a breakthrough has been effected in recent years to initiate the culture of selected species of finfishes and crustaceans. The establishment of Central Marine Fisheries Research Institute (CMFRI), Central Institute of Inland and Brackish water Aquaculture (CIBA), National Institute of Oceanography (NIO), Central Institute of Fresh water Aquaculture (CIFA), National Institute of Ocean Technology (NIOT) and Marine Products Export Development Authority (MPEDA) has led to the generation of considerable information on various aspects of Marine biology, Marine, Fresh water and Brackish water Fisheries and Oceanography. Consumption of fish for food has appreciably increased in recent years in all countries. The declaration of Exclusive Economic Zone (EEZ) has provided a great opportunity and challenge to coastal nations. In India there is good scope for development of marine resources to derive economic, social and nutritional benefits.

The nutritive and medicinal value of fish have been recognized from time immemorial. Fish flesh is an excellent source of protein in human diet. The principal biochemical contents of fish flesh are protein, fat and water. Protein constitutes about 20 percent.

The nutritional value of fish flesh is comparable and even higher than that of the flesh of birds and mammals. Fish flesh remains a good source for all essential aminoacids in needed concentrations.

The **Indian pomfret** (*Stromateus argentius*) is ranked high on the basis of its amino acid content. As a child food, fish is easily tolerated by infants. Lean fish is recommended to convalescing patients.

The nutritive value of preserved and processed fish and fishery product is generally lower than that of raw fish.

Medical and Economic importance of fish

Apart from direct consumption, contents in the body of fish are processed into a number of valuable products. Chief among these are :

Fish liver oil

Fish liver contains vitamin A and D in considerable quantities. Eg. shark liver oil and cod liver oil.

Fish liver oil can cure or prevent occurrence of deficiency diseases such as rickets, xerophthalmia, impaired vision and eye defects, abnormalities in skin, mucous membrane and vertebrae. Fish liver oil will ensure healthy growth of bones and teeth.

Fish body oil

Fish body oil is obtained from the entire body of fish. Fish body oil is generally extracted from oil sardines or from less edible varieties of fishes. It is also extracted from wastes discarded from fishery industries. Some of the important uses of oil are : 1) manufacture of cheap soaps, paints and varnishes 2) tanning of leather 3) steel and chemical industries 4) manufacture of lubricants and candles.

Fish Meal :

Fish meal is the cooked, ground and dried preparation of the fish body. It makes an excellent poultry and animal feed. It enhances egg and milk production.

Fish flour :

Fish flour is considered an ideal protein source to supplement diet of both adults and infants. It may also be mixed with wheat and maize flour. It is also used to enrich bakery products such as cakes, breads, biscuits, soup and sweets.

Fish manure and guano :

All rejected and thrown out products from fishery industry are made use of as fish manure. Fish guano is obtained as waste from fish oil industries. It is a good manure.

Fish Glue :

It is a kind of good glue obtained from fin trimmings, bones and skins of fishes. Fish glue is considered as a good adhesive.

Isinglass :

Isinglass is a high grade collagen produced from the air bladders of certain groups of fishes. It is used in the clarification of wines, beer and vinegar. It is also used in the preparation of plasters and special cements.

Fish skin :

Tanned skin of sharks and rays are used in the manufacture of shoes, handbags and wallets.

Omega Fatty acid

The unique feature which differentiates fish food from other animal protein sources is the presence of omega-3 fatty acids such as **linolenic acid**, **docosahexaenoic acid** (DHA) and **eicosapentaenoic acid** (EPA). DHA promotes learning ability in children and improved memory in elders. DHA is essential for the foetal growth and development.

Omega fatty acid is also good for heart. It helps to control diabetes by improving insulin action. It is also reported to be good for arthritis.

6. 1. 7 Guano (Bird excreta)

Guano is the accumulated excrement or droppings of fish eating sea birds such as gannets, cormorants and pelicans. It has been used as a fertilizer. These sea birds populate some islands off the west coast of Peru, lower California and Africa. Their population strength may go upto 5, 600, 000 per square mile. They may consume 1000 tonnes of fish daily. Exports of guano from the Peruvian deposits began in 1810 and reached 50, 000 tons in 1856. The Government protects the seafowls and processes the guano which contains about 11 to 16% nitrogen, 8 to 12 % phosphoric acid and 2 to 3% potash. The fertilizing properties of the phosphoric acid and nitrogen contained in fish were not recognised until the guano became a stimulus to

intensive agriculture. The real guano is found in vast stratified accretions on rainless islands off the coasts of Peru.

6. 1. 8 Aquarium

Next to birds fishes are perhaps the most colourful of animals. They are graceful in their shape, bodyform and movement. The Chinese first conceived the idea of growing fishes in and around their homes. Thus, varieties of gold fishes which are popular with aquarium lovers were bred by them from ordinary carplike fishes. **Gold fishes** are varieties of the genus *Carassius*, a fresh water group of fishes related to the carps.

An Aquarium is a container made of glass, or with glass walls. It permits watching the fishes swimming easily and for prolonged periods of time. It is a hobby which appeals to young and old and has opened up a flourishing business in all big cities.

Setting up an aquarium tank

Tank selection : The choice of an aquarium tank, depends largely on where it is to be housed, the extent of one's enthusiasm and the money one wants to spend. While selecting a tank it is very important to note that it is of good construction. Shallow and wide tanks are preferable as they have more surface area to facilitate oxygenation through atmospheric contact. Further such tanks can accommodate more number of fishes.

Before setting up the tank, a suitable place has to be selected. In order to get a good view of both fishes and plants in an aquarium tank, the light should come obliquely. Hence, instead of the window sill, a place nearer to its side may be selected. To avail maximum sunlight an eastern exposure is preferable. The support or table for positioning the tank must be strong and in level. It is also essential to have a cover with a provision for installing lights and feeding.

If the tanks are purchased they should be checked for leakage. Their sides should be cleaned with 1 % potassium permanganate solution, besides repeated washing with tap water. The next step in the setting up of an aquarium is the collection of sand that is necessary to make the bed at the bottom of the tank. The sand for the tank bottom can be collected from the sea shore or a river. This sand has to be washed to remove the dirt. It is advisable to put the sand in a shallow pan or aluminium vessel and heating it. The cleaned sand may be exposed in the bright sun. These processes ensure the killing of all

bacteria or germs. The cleaned sand should be spread evenly in the tank bottom. Over the top layer of sand a thin layer of stone chips or very small pebbles may be placed.

Quality of water for Aquarium tank

Rain water free from contaminants or tap water is ideal for aquarium tanks. A tap water of domestic supply is likely to have chlorine which is harmful to fish. This water may be stagnated for about one or two days before use. If the water is hard it must be properly treated. The tank should be filled with the desired water without disturbing the bottom sand.

Planting : The aquarium tank after being filled with water can be planted with selected varieties of aquatic plants. The plants provide shade, shelter and sanctuary for fish. Besides decorating the aquarium tank, they also help in spawning and as food for certain fishes. The plants provide oxygen through photosynthesis. Over crowding of plants has to be avoided to ensure an adequate supply of oxygen to fishes.

Several types of plants are available. Among them the important ones are the tall rooted plants such as **Vallisneria** and **Myriophyllum**. Before planting, the plants must be washed well otherwise disease causing parasites may attack the fish at a later stage. Plants may be disinfected by rinsing in 0.1 percent solution of alum (Potassium aluminium sulphate) followed by a good washing in water. The roots are trimmed and are kept between wet newspaper sheets to prevent them from drying before they are set. The plants are carefully installed using a forked wooden piece. Large plants like vallisneria may be planted at the back while the bushy plants can be placed in the corners or at sides. The floating plants may be necessary in tanks where gouramies are bred. The fragments of these plants are used by these fishes in the construction of bubble nests for breeding.

Lighting : Light besides beautifying the aquarium helps in the photosynthesis of aquarium plants. Fishes also require light to trace their food. Further the light is known to influence the growth of fish. Strong sunlight destroys bacteria and keeps the tank healthy. For a moderate tank two bulbs of 60 watts each may be lit for eight hours a day. It is better to use fluorescent lighting for promotion of plant growth and for even distribution of light.

Common ornamental fishes

Live bearers

- Guppy - *Lebistes reticulatus*
- Platy - *Xiphophorus maculatus*
- Sword tail - *Xiphophorus helleri*
- Black molly - *Mollienesia sphenops*

Egg Layers

- Siamese fighter - *Betta splendens*
- Giant gourami - *Colisa fasciata*
- Kissing gourami - *Helostoma temmincki*
- Angel fish - *Pterophyllum scalare*
- Gold fish - *Carassius carassius*

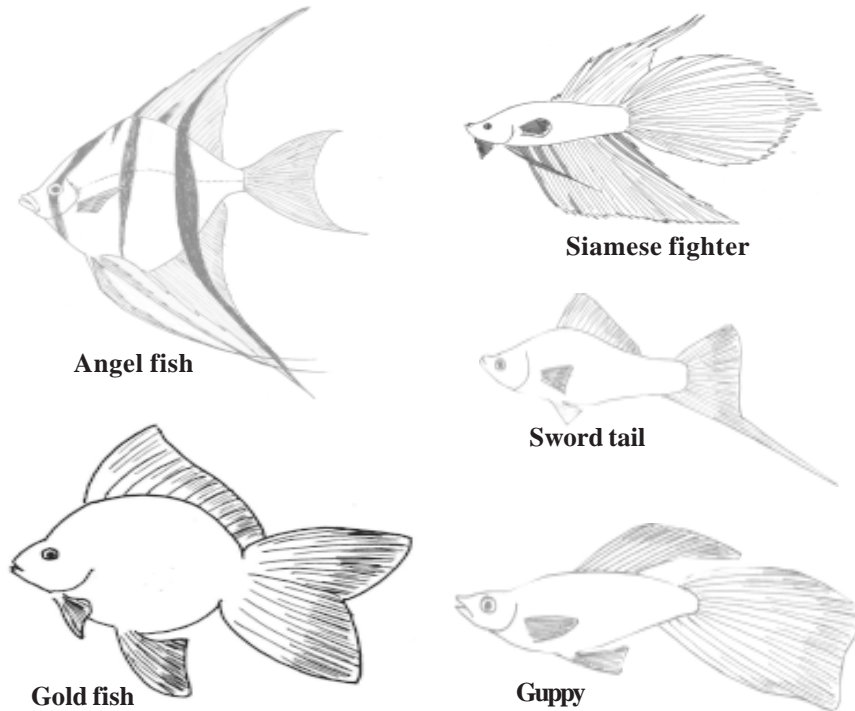

Fig. 6.1.11. Ornamental fishes

Introduction of fish in an aquarium tank.

The number of fishes suitable for stocking in an aquarium tank depends mainly on the surface area of the tank, its dissolved oxygen content and size of the fish. It is reported that 1 cm long fish may need about 75 cm² of the surface area. Based on the above, a tank of 75 X 30 cm size for example may hold three fishes each of 10 cm length.

The fishes are generally introduced two to three days after planting when the water would be clear and well oxygenated by plants. Before introduction into the aquarium tank, the fish may be treated with 2 percent potassium permanganate solution to avoid parasitic attack.

Feeding

Algae which often grow around stones and in water serve as a good food source to swordtails, kissing gourami and mollies. Live protein rich foods such as tubifex worms, Chironomid larvae and mosquito larvae are considered excellent. Artificial fish feed meant only for aquarium fishes can also be used.

Fishes may be fed once or twice a day according to their preference and satiation. Excess food and detritus may be removed 30 minutes after feeding, by siphoning out using a rubber tubing. If the level of the water gets reduced in course of time it should be restored by the addition of some rain water or chlorine free tap water.

Aesthetic value :

A large number of fishes are cultured in aquaria for their beauty and graceful movements. The movements of colour fishes in an aquarium would certainly please the ailing and convalescing people. The aquarium may gladden one's heart.

Vivarium (Zoo)

The growing awareness for nature and wild life conservation has made zoos a popular institution. Estimates indicate that 10% of the world's human population visit zoos every year. There are about 350 animal collections in India, which are visited by more than 50 million people annually. Most zoos until the last two decades were set up mainly for entertainment and recreation, with the result the scientific management of wild animals in captivity has evolved slowly.

The need for making conservation as one of the main objectives of management of zoos was realised by Government of India soon after independence. Indian Board of wild life made important recommendation in this regard. Today wildlife habitats are under severe pressure and a large number of species of wild fauna have become endangered. The zoos apart from sustaining their own populations have to augment the depleting populations of endangered species in the wild. As zoos are visited by a large number of visitors, they are potent tools for educating people about the important of wild life management as it remain a life supporting processe of nature.

Objectives

The main objective of the zoos shall be the conservation of the rich biodiversity of the country, particularly the wild fauna. This objective can be achieved through the following methods.

1. Supporting the conservation of endangered species, which have no chance of survival in wild.
2. To inspire amongst zoo visitors empathy for wild animals, an understanding and awareness about the need for conservation of natural resources and for maintaining the ecological balance.
3. Providing opportunities for scientific studies useful for conservation.

Safari :- Safaris are specialized zoos where the captive animals are housed in very large naturalistic enclosures and the visitors are allowed to enter the enclosure to view the animals in a mechanised vehicle or a predetermined route and watch the animals from close quarters.

List of important Zoos

1. Indira Gandhi Zoological park, Visakha patnam, A. P.
2. Nehru Zoological park, Hydrabad, A. P.
3. Assam state Zoo-Botanical Garden, Guwahati, Assam.
4. Sanjay Gandhi Biological park, Patna, Bihar.
5. National Zoological park, Delhi.
6. Kamla Nehru Zoological Garden, Ahmedabad, Gujarat.
7. Sri Chamarajendra Zoological Garden, Mysore.
8. Nandankanan Biological park, Orissa

9. Mahendra Chaudhury Zoological park, Punjab.
10. Arignar Anna Zoological park, Vandalur, Tamil Nadu.
11. Kanpur Zoological park, Kanour, U. P.
12. Zoological Garden, Calcutta.

6. 2 Harmful Animals

The harmful animals are those that cause injury to plants and domestic animals. Human beings are affected directly or through bites or stings or by transmission of various kinds of pathogens. The nature of harmful insects ranges from simple nuisance value of cockroaches to spreading of epidemic diseases, such as malaria, filariasis by mosquitos. For the convenience of our study the harmful animals are grouped under the following categories namely disease causing organisms, poisonous animals, fouling organisms and pests.

6. 2. 1 Disease causing organisms - Vectors

Some insects are injurious to man as vectors of human diseases. Through the ages millions of people have died of dieases transmitted by insects. There are a number of insect-borne diseases, and they may be transmitted in different ways.

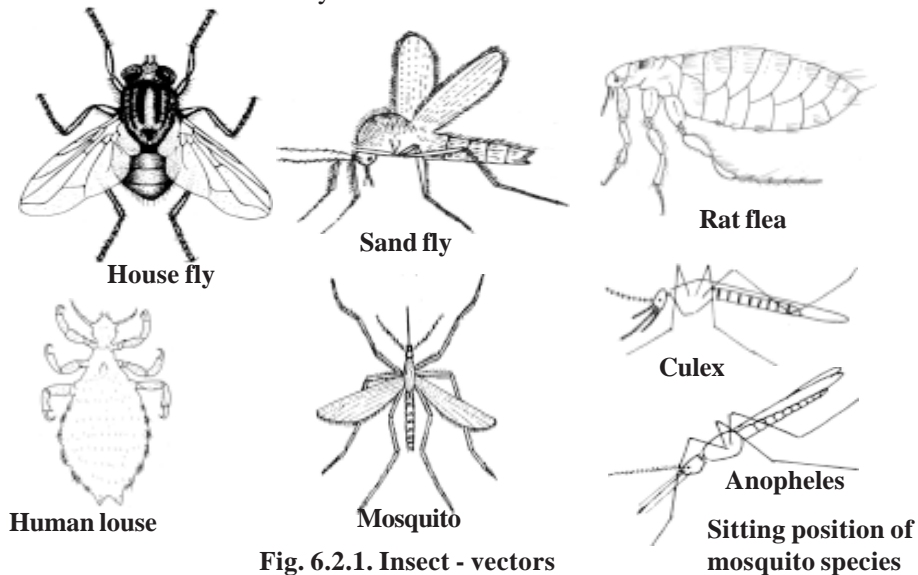

Fig. 6.2.1. Insect - vectors

1. Housefly - *Musca domestica*

House flies are cosmopolitan in distribution. They are closely associated with humans and thrive best where people are careless in the disposal of wastes. Adult flies are non-parasitic.

They feed on all kinds of decaying and decomposing matter. It is an important mechanical vector in the transmission of diseases like **typhoid** (*Salmonella typhosa* - a bacterium), **dysentery** (*Entamoeba histolytica*) and **cholera** (*Vibrio* spp.) The housefly cause diseases through food **contaminations**.

Control : Housefly control is normally done in 3 different ways, namely sanitary, mechanical and chemical methods. Populations of houseflies can be controlled by proper disposal of manure, garbage, sewage, food waste, human excreta and other organic materials. Mechanical practices such as screening, using of traps or sticky paper or baits can be valuable in excluding houseflies. Insecticides may be used against larvae. Spraying with 2% malathion 1% chlordane or lindane, 0.5% tremphos are effective.

2. Sand flies - *Phlebotomus papatasi*

These flies are 4 mm long. Only the female possess piercing-sucking mouth parts and are haematophagous. The males are non parasitic, feeding on moisture. They are small slender insects with hairy bodies. Through biting this fly transmits the disease called **kala-azar**. The causative organism is **Leishmania**, a parasitic protozoan. During the day time the flies remain hiding. At night they come out to feed. The sand fly attacks during night times. The insect sucks the parasite from an infected person, along with blood. In side the body of the fly, the parasite undergoes changes. When an infected fly bites man, the parasites pass into the blood and fresh infection is effected. The parasites mostly concentrate in the capillaries of spleen, liver and bone marrow. The disease is characterized by the symptoms like anaemia and emaciation.

Control :

Spraying of 5 % DDT / BHC easily kills the flies. The pyrethrum ointment used on exposed part of the body works as a repellent.

3. Rat fleas - *Xenopsylla cheopis*

The insect parasite, *Xenopsylla cheopis* is commonly known as the Asiatic **rat flea**. Both male and female fleas take in the bacillus pasteurella

pestis from infected rats during feeding. This rat - flea is responsible for the transmission of plague from man to man, or from rat to man. When this bacterium is introduced into the skin, the lymph glands become inflamed. This is known as **bubonic plague**. Frequently, the bacilli become established in the victims blood. The condition is then referred to as **septicemic plague**. If the victim's lungs become involved, it is referred to as **pneumonic Plague**

When the rat flea sucks the blood of man or a rat infected with plague, the bacilli enter into its stomach and grow there into large numbers. The flea thus heavily laden with the bacilli, may bite a healthy man and introduce the bacilli into the wound and cause infection. The bacilli are deposited by the flea on the skin along with the faeces. The bite of the flea causes scratchings and the bacilli are introduced into the blood when the skin is scratched.

Control :

Destruction of rats and other rodents is an effective method. Dusting of 1 to 2 % chloradane, or 2 % Y - BHC is very much effective in the elimination of fleas on the body of pet animals. Application of 5% DDT is recommended for spraying at the time of the spread of plague in all the areas.

4. The human louse - *Pediculus humanus*:

Louse is a blood sucking ectoparasite of man. It is cosmopolitan in distribution .

The human louse is a major vector for three important human diseases, relapsing fever, typhus and trench fever.

Disease	-	Parasite
Relapsing fever	-	<i>Borrelia</i> sp
Typhus	-	<i>Rickettsia</i> sp
Trench fever	-	<i>Rickettsia</i> sp

Control : Wearing clean clothes, and having regular bath avoids infestation.

5. Mosquitoes : Anopheles, Culex, Aedes sp.

Mosquitoes are cosmopolitan in distribution. They are nocturnal in habit and are found in abundance in damp, marshy lands near stagnant water. Only female mosquitoes are adapted to suck the blood of human beings and function as carrier of viral, protozoan and nematode diseases.

Culex mosquitoes serve as the vectors for **filariasis** or **elephantiasis**. This disease is caused by the nematode parasite, *Wuchereria bancrofti*. It is commonly known as filarial worm. It is found in the lymphatic vessels and lymph glands of man. The female worms give birth to living embryos known as *microfilariae*. The microfilariae normally circulate at night (10 to 2 am) in the peripheral blood. At that time they are ingested by the mosquito along with blood, the mosquito is not just a mechanical carrier of the parasite. Developmental changes take place in the body of the parasite. When the infected mosquito next bites another person, the larvae penetrate the superficial skin to find their way into the lymphatic vessels, and attain sexual maturity. In severe infection the adults cause blocking of lymphatic system which results in the enlargement of legs, arms, scrotum, and mammary glands. It is known as **elephantiasis**.

The Anopheles mosquito transmits plasmodium, a causative protozoan for malaria (Refer : Plasmodium)

Another type of mosquito, Aedes transmits yellow fever through a virus.

6.2.2 Poisonous Organisms

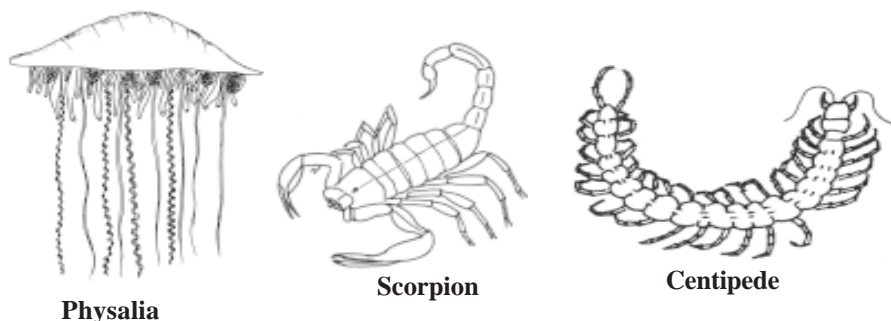

Fig. 6.2.2. Poisonous animals

Free living organisms have developed some device to protect themselves against predators. These protective devices ranges from the simple stinging cells of Physalia to the massive poison glands of the snakes. The list of poisonous organisms is exhaustive. A few of the important poisonous organisms are mentioned here.

Physalia

These are marine coelenterates. They are notorious for the painful sting they can inflict on unsuspecting swimmers who accidentally brush against them. They attack using stinging cells on their trailing tentacles. Their powerful stings cause painful local inflammation and can even be fatal.

Scorpion.

In scorpion the sting is attached to the posterior part of the last segment. It consists of bulbous base and a sharp curved barb that injects the venom. The venom is produced by a pair of oval glands. The scorpion raises the posterior abdomen over the body making it curved forward. A stabbing motion is used in stinging.

The venom of most scorpions is sufficiently toxic to kill a vertebrate. The venom of the scorpion *Androctonus* is equivalent in toxicity to cobra venom.

The neurotoxic venom of scorpions is very painful and may cause paralysis of the respiratory muscles or cardiac failure in fatal cases. Anti venoms are available for these species.

Centipede :

Centipedes are distributed throughout the world. They live in soil and humus and beneath stones. The largest centipede is the tropical American *Scolopendra gigantea* which may reach 26 cm in length. They have a large pair of poison claws sometimes called maxillipeds. Each claw bears a terminal pointed fang. The venom although painful is not sufficiently toxic to be lethal to man even to small children. However *S. gigantea* has been known to cause human death.

Honey bees and Wasps :

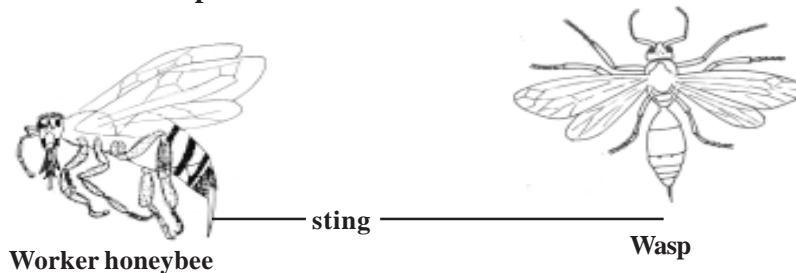

Fig. 6.2.3. Poisonous insects

In **worker honey bee** (undeveloped females) the poisonous sting is situated at the hind end of the body. It is a pointed structure provided with minute hooks or barbs at its free end. On stinging the tip of sting gets detached. Hence a bee can sting only once.

Unlike the bee the **wasp** is able to withdraw its sting from the wound. Hence it can sting again. In wasp the sting is a modified ovipositor and once it has penetrated the skin of the victim poison is injected as in a hypodermic syringe. The wasp's poison is a **histamine**.

The sting by honey bees and wasps lead to pain and inflammation.

Poisonous fishes

More than 700 species of fishes have poison glands. Venom in fishes is of two kinds. One kind of venom is produced by specialized glands which may occur in various parts of the body. In the second, the flesh itself may secrete some toxic substance and the fish becomes poisonous and inedible.

There are several poisonous **cartilaginous fishes**. The poison glands are usually associated with a spine or sting as in the case of **sting ray**. In the sting ray (**Trygon**), the poison glands lie along a lateral groove on each side of the spine on its tail. The spine causes pain and numbness in the flesh of victim.

The large **Barracuda** of Cuba and other tropical islands have poisonous flesh, which when eaten cause pain in joints and extremities, nausea, vomiting and general trembling.

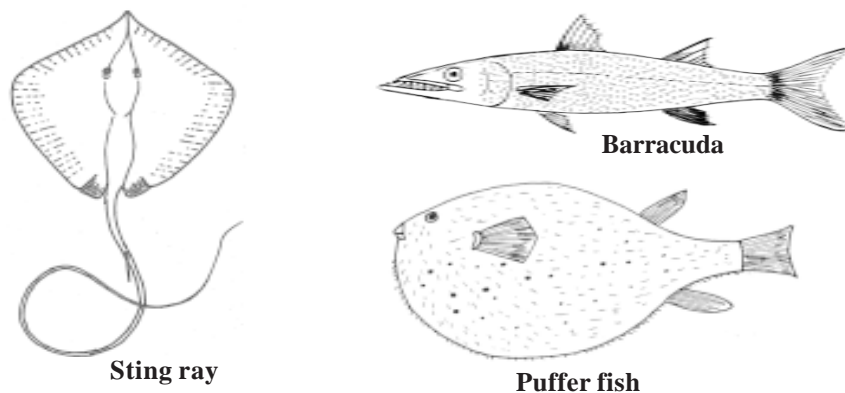

Fig. 6.2.4. Poisonous fishes

The **Puffer fish**, (*Tetrodon*) is considered to be world's most dangerous fish. Its ovaries, intestine, kidneys, skin and eyes contain a neurotoxin called **Tetrodotoxin**. This toxin has no antidote. It is several times deadlier than cyanide. In a dilute form, tetrodotoxin is used as a pain killer for victims of neuralgia, arthritis and rheumatism

Poisonous snakes

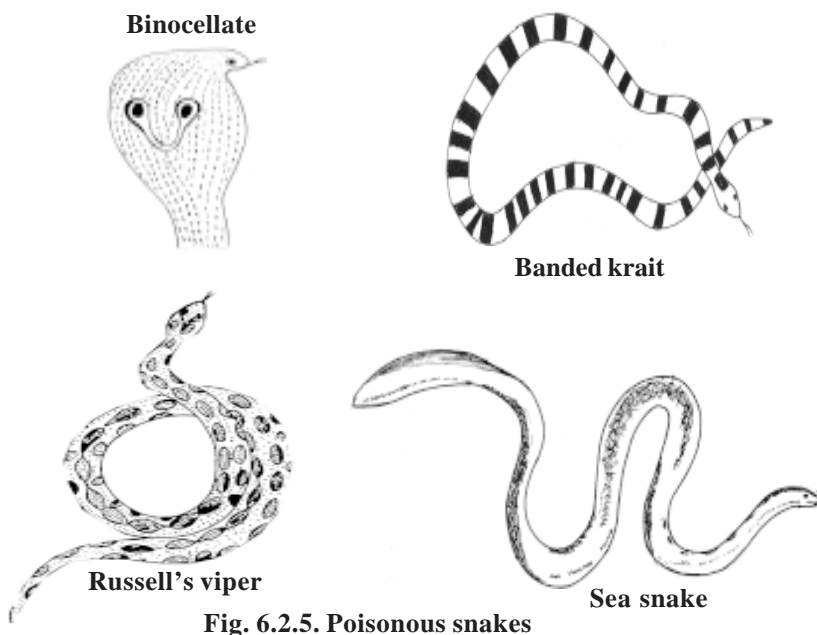

Fig. 6.2.5. Poisonous snakes

Indian poisonous snakes are the **cobras**, the **kraits**, the **vipers** and the **sea snakes**. These can be distinguished from the non poisonous by the tail, the arrangement and size of scales, plates and shields found over the body.

Cobra : It is well known all over India. When provoked it raises its head and expand the skin of the neck region in the form of a characteristic hood. The hood may bear a spectacle mark. Such cobras are called two ringed or spectacled forms. In others there is a oval spot surrounded by an ellipse. These are known as the one ringed or monocled variety. They are found in Bengal. In still others there is no mark on the hood. Only two species of cobra are found in India. They are *Naja naja* (Indian cobra) and *Ophiophagus hannah* (king cobra).

Krait : These are common poisonous snakes of India. There are two common Indian kraits. They are the common krait (*Bungarus coeruleus*) and the banded krait (*B. fasciatus*).

Vipers : There are two classes of vipers. Some have a distinct pit on the sides of the head between the nostril and the eye in the region called 'lore'. These are called **pit vipers**. The other one is the **pitless viper**. Vipers are viviparous in nature.

The vipers have movable upper jaw, so that the fangs when not in use can be folded backwards. It gets erected with the opening of the mouth while inflicting injury. It produces a loud hissing sound by expelling air through nostrils.

Pitless Viper - *Vipera russellii* (Russell's viper) *Echis carinata* (The little Indian viper).

Pit viper - *Trimeresurus* sp

Sea Snakes : Sea snakes can always be distinguished from other snakes by their laterally compressed tails. This is an adaptation to their life in the sea. All sea snakes are highly poisonous.

Eg. *Hydrophis* sp *Enhydrina* sp

Poison Apparatus of a Snake

The poisonous snake possesses a poison apparatus comprising of a pair of poison glands, a pair of poison ducts and a pair of fangs. The poison glands are situated on either side of the upper jaw below and behind eyes. They are specialized salivary glands. A duct carries the venom secreted from each gland to the fang. A fang is meant for injecting the venom into the body of the prey. Fangs are specialized teeth of the upper jaw which are tubular or grooved.

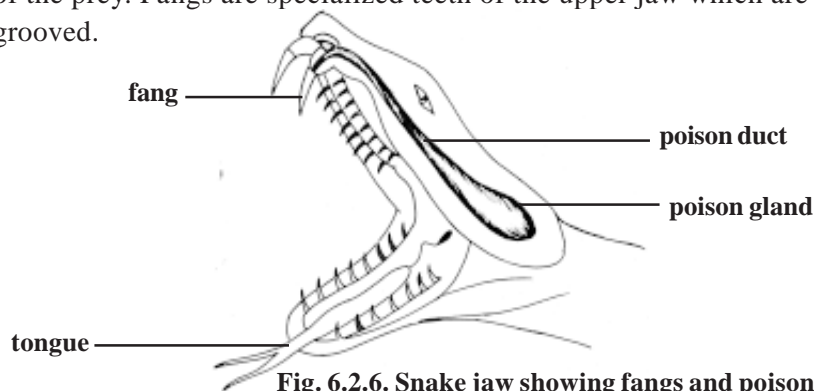

Fig. 6.2.6. Snake jaw showing fangs and poison glands

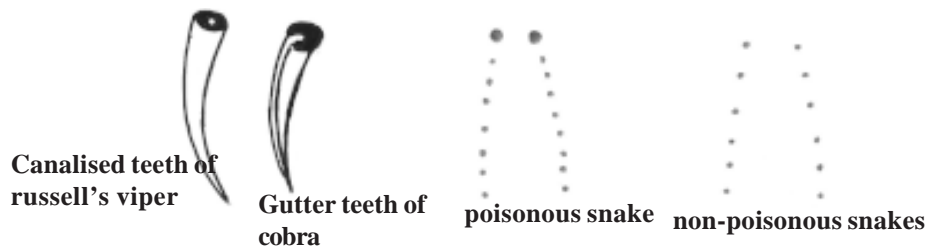

Fig. 6.2.7. Fangs of snakes and marks left by the bite of poisonous and non-poisonous snakes

Biting mechanism in Cobra

Cobra is not an aggressive snake. When disturbed, it attempts to escape. When the snake attacks, the mouth opens by lowering the lower jaw. This makes the fangs to be erect to penetrate the muscles of the victim. When the mouth is closed the poison glands are pressed. The venom thus reaches the fangs and is injected into the body of the victim. This whole process takes place in no time.

Snake Venom

There are two types of snake venoms. One type acts mainly on the nervous system (*neurotoxic*). It affects the optic nerves (*causing blindness*) or the phrenic nerve of the diaphragm (causing paralysis of respiration). The other type is *haemolytic*. It breaks down the red blood corpuscles and blood vessels and produces extensive extravasation of blood into the tissue spaces.

6. 2. 3 Fouling Organisms

Several aquatic organisms cause damages to submerged surfaces. Since this infestation has an economical importance, several studies are being made. Marine sedantary organisms may affect piles, floats, wooden dry docks and boats. These organisms are called **foulers**. Most of these organisms are distributed all over the world through the agency of ships.

They are of economic importance, since fouling of ships results in increased resistance to movement through water, reducing the efficiency, lowering of speed, increasing fuel consumption and leading to wear and tear of engine. The efficiency of underwater sound equipments fitted on to commercial and naval vessels is also seriously affected as result of the accumulation of fouling organisms.

Pipes and conduits used to convey salt water in ships, industrial plants, oil refineries, nuclear power plants and aquaria become clogged and the flow is interrupted by the growth of these organisms inside the pipe. Thus the problem of fouling organisms is serious.

Factors influencing the settlement of fouling organisms

Several factors are known to influence the settlement of larvae of fouling organisms. The most important of which is recognised to be the formation of the **primary film**. It is composed chiefly of diatoms and algal spores with a relatively small portion of bacteria. The thin filaments of algae may afford foothold on the substratum for the larvae to settle. The algae and diatoms serve as food for these larvae.

Members of the fouling community

The most important members of the fouling community include algae and representatives from almost all the invertebrate groups and the tunicata. Among the molluscs the mussels are the most important foulers. They settle heavily, especially in the pipe systems carrying seawater and obstruct the flow of water. Among Arthropoda, the barnacles are the dominant representatives of the fouling community. There are over 100 species of barnacles as foulers.

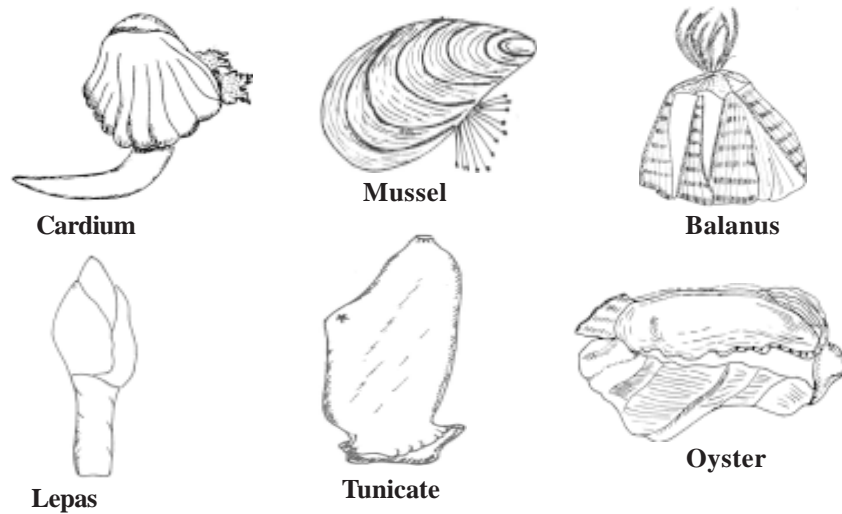

Prevention of fouling.

Fig. 6.2.8. Common foulers

1. Using copper sheathing on wooden hulls of boats.
2. Applying suitable antifouling paint.
3. Chlorination in condenser system.

6. 2. 4 Pests

Any animal which becomes a source of trouble or loss to human is called a pest. Among insects such pests are numerous and are of different kinds. An insect is usually called as a pest when it causes appreciable damage and loss to the crops or other belongings. The pests may be classified as major or occasional. The insects damaging standing crops cereals, fruits and other plant products of commercial importance are designated as **crop pests**. Those insects destroying stored grains are called the **store pest**. Insects causing damage to household articles are called the **household pests**.

Pests of Crops

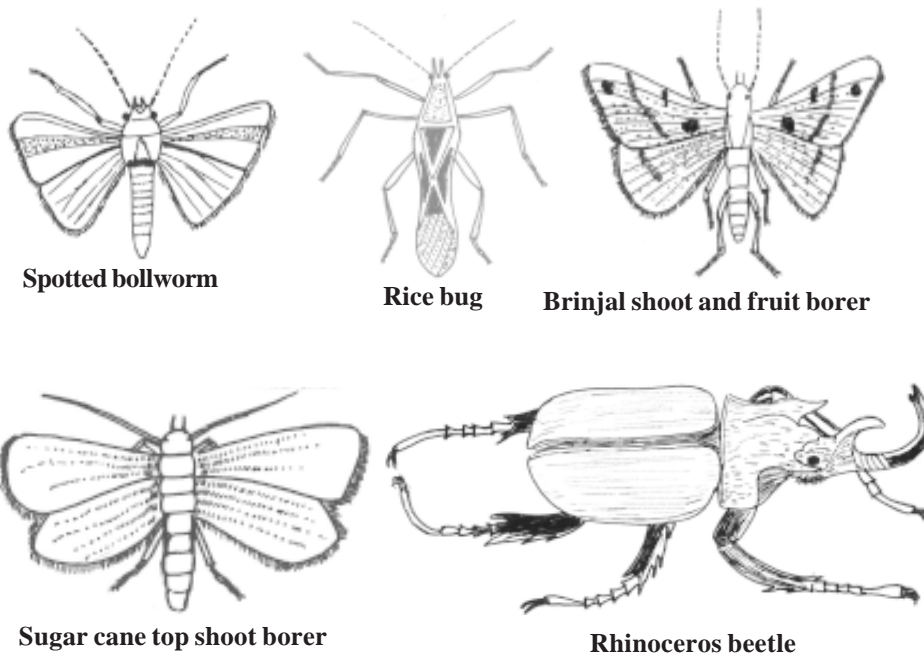

Fig. 6.2.9. Common pests of crops

I. Pest of Cotton

a. Pink boll worm - *Pectinophora gossypiella*

This pest causes damage to the buds, flowers and seeds.

b. Red cotton bug - *Dysdercus koenigii*

This bug sucks the cell sap of green bolls and leaves.

c. Spotted boll worm - *Earias vitella*, *E. insulana*

These two species are the most important pests of cotton in India causing heavy losses to the crop every year. *E- vitella* is abundant in high rainfall areas, where as *E- insulana* abounds in areas receiving scanty rains. The caterpillars of *Earias*. bore into the stem portion of young seedlings and apical shoots and later eat into buds, flowers and bolls. The attacked shoots wither, droop and ultimately die.

Control : The attacked shoots and bolls should be collected and destroyed. Avoid growing lady's finger during the offseason in the vicinity of the cotton fields. Insecticidal control of the pest consists of spraying is done every 15 - 20 days of monocrotophos, endosulfan or malathion.

II. Pests of Paddy

a. Rice stem borer - *Tryporyza incertulas*

This pest bores into the stems of the young mature stages of paddy.

b. Rice bug - *Leptocorisa acuta*

It is the most important pest of paddy in India. It mainly feeds on paddy but is also found feeding on millets, maize, sugar cane and some grasses. The adults and nymphs feed on the milky juice of the forming grains which as a consequence become chaff.

Control : In nurseries and fields , the leaves of paddy plants containing eggs should be clipped and burnt. As the bugs feed and breed on various types of grasses, removal of such grasses from the fields will help in reducing the population. Collection of bugs with a hand net and their destruction is a useful **mechanical method**. Among the insecticides BHC and malathion as **dusts** and carbaryl and methyl parathion as **sprays** just before flowering of the plants are effective.

III. Pest of Sugarcane

- a. Indian sugarcane leaf hopper - *Pyrilla perpusilla*.

This pest sucks the cell sap of leaves.

- b. Sugarcane root borer - *Emmalocera depressella*.

This pest causes damage to the stem below the soil surface.

- c. Sugarcane shoot borer - *Chilo infuscatellus*.

This pest causes damage to the shoot.

- d. Sugarcane top shoot borer - *Scirpophaga nivella*

It is one of the most destructive pests of sugarcane. It is found all over India. The damage by the borer actually starts from the mid-rib of the top leaves into which it bores and makes tiny holes. When the growing point is damaged, side shoots are formed in the young plants and bunchy tops in the older ones. The quality of the juice is also affected.

Control : Effective control of this pest is possible only by integrating mechanical and chemical control methods. Mechanical methods include the collection and destruction of egg masses and affected top shoots and sowing of resistant varieties. The chemical methods involve application of 4 % carbaryl or endo sulfan granules in the leaf whorls or spraying of 0.05 % monocrotophos or 0.1 % endrin.

IV. Pests of Vegetables.

- a. The red pumpkin beetle - *Raphidopalpa foveicollis*.

This pest causes damage to the leaves, flowers and buds of younger plants.

- b. Cabbage butterfly - *Pieris brassicae* .

This pest causes damage to the leaves.

- c. The Hadda beetle - *Epilachna dodecastigma*.

This pest causes damage to the leaves of the brinjal, potato and tomatoes.

- d. Brinjal shoot and fruit borer - *Leucinodes orbonalis*.

It is the most important and destructive pest of brinjal and has a country-wide distribution. The pest starts damaging the brinjal plant a few weeks after its transplantation. When the shoot is attacked by the caterpillar it droops and withers, finally drying up. When the petioles of the leaves are bored into by the larva the

leaves wither and drop. The attacked fruits show holes plugged with excreta on them. Upto 70 % loss of crop is caused by this pest.

Control : Prompt collection and destruction of the plant parts harbouring larvae help in reducing the infestation. Insecticides such as carbaryl, endosulfan, Lindane and diazinon, when applied at regular intervals give relief from heavy infestation.

V. Pest of Coconut palm

Rhinoceros beetle - *Oryctes rhinoceros*. It is distributed throughout South East Asia, Southern China, Philipines and south Pacific Islands. The adult causes infestation by feeding the young leaf fronds. They make burrows and throw out a fibrous mass. The infestation is marked by a number of holes on the fronds, when they open out . The attack results in the destruction of growing plant as a result of which the tree dies.

Control : The beetles should be destroyed by inserting specially designed hooked rod. In earlier developmental stages beetles should be destroyed by tackling the breeding places like manure pits near gardens by spraying 0.01% aldrin.

VI. Pests of Stored grains

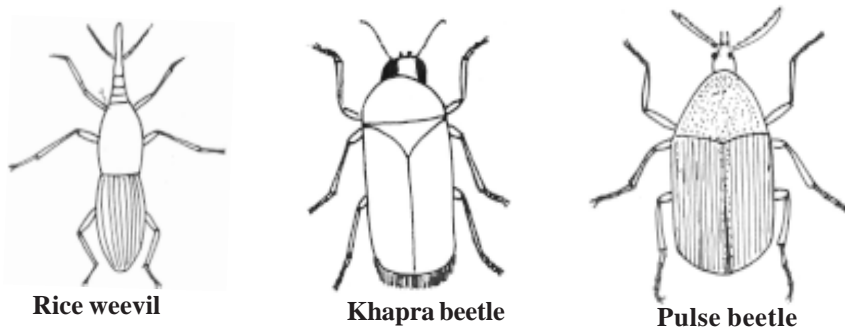

Fig. 6.2.10. Pests of stored grains

a. Rice weevil - *Sitophilus Oryzae*

This is a very serious major pest of stored grains in farm storage. It is worldwide in distribution. Generally, infestation starts in grains only during storage which may lead to heat spots in the grain. The grains are hollowed and the weight is reduced.

Control : The weevil is unable to breed at a grain moisture content of 9 % or less. Hence dry storage of grains can avoid infestation by the pest. The larvae and adults are killed by exposing them for 48 hrs to the vapours of ethylene dichloride

- carbon tetra chloride mixture under gas - proof covers. Fumigation of infested grains with methyl bromide is also effective and kills all stages of pest including eggs.

b. Khapra beetle - *Trogoderma granarium*

Khapra beetle is a very serious pest of wheat and other stored grains all over India. Only the larval stage is destructive, adult beetle being harmless. The grubs attack the germ portion of the grain. In severe infestation the cereals are reduced to mere frass.

Control : Stocks of grains should be stored in thoroughly clean and insect-free stores which are regularly aerated. Before storage of grains, the godown should be properly disinfected with benzene hexachloride smoke or fumigants.

c. Pulse beetle - *Callosobruchus Chinensis*

This is a very important pest of various pulse crops in India. It affects both in fields and in stores. The pest attacks leguminous pods in the field from where they are carried to godowns. The larvae bore into the pulses and grains. They feed and grow inside. The damaged grains are unfit for human consumption.

Control : Control can be achieved by growing susceptible crops atleast a kilometre away from storage godowns which are the main source of infestation. **Fumigation** with methyl bromide in the godown is very effective but proper care must be taken because of the high toxicity of this compound.

VII. Pests of household goods



Silver fish



Termite

Fig. 6.2.11. Pests of household goods

a. **Termites (white ants) - *Odontotermes obesus***

There are more than 2000 species of termites. The food of termites consists primarily of wood (cellulose). This habit of termites is the cause for very serious losses, particularly in tropical countries. They destroy wood work, furnitures, buildings, fences and other wooden structures that come into contact with the soil. The losses caused by termites to Indian agriculture and other commercial crops are extensive. About 40 species of termites are injurious to economic plants such as wheat, barley, maize, gram, sugarcane, groundnut, several vegetables, fruit trees and coconut in India.

Control : The seriousness of their attack demands immediate control. For termite control, insecticides should be applied to the soil. Emulsions of 1 % chlordane, 0.5 % aldrin and 0.5 % heptachlor are suitable for soil treatment. 5 % pentachlorophenol is good for wood preservation. The application of a mixture of BHC and aldrin to soil in the foundations of a building is effective.

b. **Silverfish - *Lepisma saccharina***

It is cosmopolitan in distribution. It is commonly found living in moist warm places and among old books. It is a whitish wingless insect of about 13 mm in length. It mostly attacks old books and magazines. It infests starched clothes, rayon fabrics, book labels or bindings where glue has been used.

Control : The books should not be kept in damp places. Books should be exposed to sunlight frequently. Dusting of 5% malathion has proved to be an effective control measure for heavily infested cases.

Self - Evaluation

Part I

Choose the correct answer.

1. Reef forming corals normally grow in
 - (a) cold waters
 - (b) deep seas
 - (c) shallow, tropical seas
 - (d) polluted and muddy waters
2. The Great Barrier reef occurs in
 - (a) Gulf of kutch
 - (b) Carribean islands
 - (c) Andaman islands
 - (d) the coast of Australia
3. Earthworm commonly employed in Indian vermiculture is
 - (a) *Lampito mauritii*
 - (b) *Apis indica*
 - (c) *Panaeus indicus*
 - (d) *Pinctada fucata*

4. The degrades of organic matter by worm activity is
(a) lac (b) isinglass
(c) vermicompost (d) guano
5. The honey bee used commonly in bee-keeping industry is
(a) *Apis dorsata* (b) *Apis florea*
(c) *Apis indica* (d) all the above
6. The silk produced by *Bombyx mori* is
(a) tasar silk (b) muga silk
(c) arandi silk (d) mulberry silk
7. The predatory insects are said to be
(a) entomophagous (b) larvivorous
(c) parasitic (d) pests
8. The organization involved in pearl oyster culture is
(a) CIBA (b) CMFRI
(c) NIO (d) MPEDA
9. The most common freshwater prawn used in aquaculture is
(a) *Macrobrachium* sp (b) *Metapenaeus* sp
(c) *Penaeus* sp (d) *Panulirus* sp
10. The name Kal Eral in Tamil refers to
(a) Prawns (b) crabs
(c) a fish (d) lobsters
11. The fish *Stromateus argenteus* is popularly called as
(a) guppy (b) pomfret
(c) gold fish (d) angel fish
12. Which part of the body in fish provides isinglass
(a) skin (b) liver
(c) air bladder (d) bone
13. Which country was economically benefitted by marketing bird excreta
(a) USA (b) Peru
(c) Australia (d) West Indies
14. The idea of aquarium maintenance was first conceived by
(a) Chinese (b) Japanese
(c) Red Indians (d) Africans

15. Nandankanan Biological park is situated in
 (a) Delhi (b) Orissa
 (c) Bihar (d) Assam
16. The pneumonic plague affects
 (a) liver (b) brain
 (c) lymph glands (d) lungs
17. Which is the best time to have blood test for filariasis
 (a) morning (b) evening
 (c) noon (d) mid-night
18. The characteristic feature of tail in sea snake is
 (a) round (b) pointed
 (c) compressed (d) cylindrical
19. *Ophiophagus hannah* refers to
 (a) Indian cobra (b) King cobra
 (c) Russell's viper (d) Sea snake
20. The silver fishes commonly live among
 (a) rocks (b) algae
 (c) other fishes (d) old books

Part II

Give very short answer

1. What is a fringing reef ?
2. Mention the use of vermicompost.
3. How are insects useful to flowering plants in reproduction ?
4. Name any two edible crabs.
5. Provide the names of one live bearer and one egg layer from among the ornamental fishes.
6. Provide the names of zoos in the states of Tamilnadu and Andhra Pradesh(one each).
7. Name the two types of venom released by poisonous snakes.
8. Provide atleast one major role of CMFRI.
9. Name any two cultivable animals.
10. What is *Corallum rubrum* ?

Part III

Answer briefly

1. What is Biological control ? Explain with an example.
2. Provide an account on Indian prawns of commercial importance.
3. Give an account of cultured pearls.
4. Write notes on omega fatty acids.
5. What is guano ? comment on its economic importance.
6. Write notes on *Xenopsylla cheopis*
7. Give an account on fouling organism.
8. Draw and label the poison apparatus in a snake.

Part IV

Answer in detail.

1. Give an account of insects and insect products of commercial importance.
2. What are the nutritive values of fishes.
3. Give a detailed account on setting up an aquarium and maintaining the same.
4. Write an essay on insect pests of stored products and household goods.

Identify and name

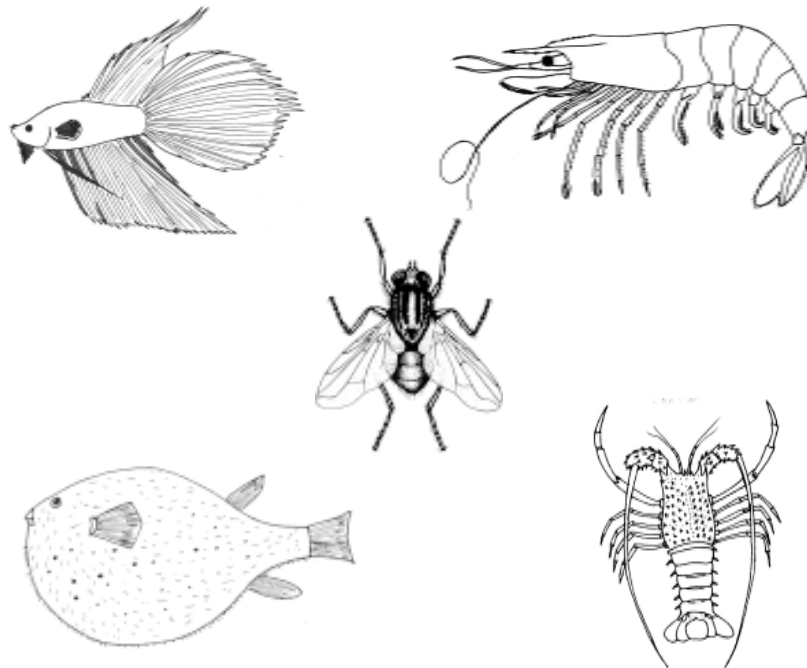

7. ORIGIN OF LIFE

7.1. Theories

Origin of life

Our planet earth is inhabited by an enormous variety of living organisms. The plants and animals show remarkable biodiversity. The diversities mostly appear as adaptations for diverse habitats and living methods adopted. This vastness has always made people wonder about the origin of life and diversity. To a certain extent Charles Darwin's natural selection concept provides an explanation towards an understanding of evolution of various kinds of life forms. However the theory of origin of life is still a matter of speculation. Several intelligent explanations had been provided to account for the origin of life on earth.

1. Theory of special creation

According to the proponents of this theory all living forms with their richness in diversity were created abruptly by a super natural power. The support or acceptance of this theory is mostly due to faith rather than experimental or scientific evidences. However, supporters of this theory have recently created a new discipline called "creation science".

2. Cosmozoic theory

This theory states that life came to earth from some other planet or star. The resistant spores that lead to life on earth are named as 'cosmozoa'. They reached earth accidentally. Under favourable conditions they evolved and produced all forms of life on earth. An acceptance of this theory needs evidence for the existence of extra-terrestrial life.

3. Theory of spontaneous generation or abiogenesis

The theory that life originated from non-living material is now called **abiogenesis**. An earlier version of this theory was **spontaneous generation** or the origin of life without apparent cause. The ancient Greek philosophers like Thales, Empedocles and Aristotle supported this concept.

Thales (624-548 BC) suggested that oceanic water was the mother from which all living forms originated. According to **Empedocles** (540-433 BC) life originated by itself from non living matter and imperfect forms were

replaced by perfect forms. **Aristotle** (384-322 BC) proposed that living forms are animated forms of non-living matter. The activation was due to vital forces or guiding intelligence. He further stated that the vital forces operate constantly and improve the living world.

In the 17th century the idea of abiogenesis was opposed by an Italian physician **Francisco Redi** (1621-1697). For the first time he proposed through experiments, that life could arise only from pre-existing living things. He tested his hypothesis by sealing meat inside four closed flask, while leaving another four meat filled flasks open. Soon the meat in the open flasks was full of maggots. Flies were entering and leaving the flask. Even after many days no worm appeared in the closed and sealed flask. This experiment confirmed his idea that new life can come only from early life.

4. **Big Bang theory**

This theory is concerned with the origin of earth and other planets. According to this theory the universe originated in a 'big bang'. All matter was created in this big bang including the matter of which stars and planets are composed of. According to this theory as a young star increases in density, it gets heated up due to increasing pressure. When a certain critical temperature is reached thermonuclear reactions will begin and cause a 'big bang'. It is believed that our sun was formed in this way.

5. **A. I. Oparin's theory**

Alexander I. Oparin, a Russian chemist published a paper in 1924. He advanced a new theory regarding origin of life. This theory is called the "theory of primary abiogenesis". According to Oparin conditions on Earth today are no longer suitable to the production of life from non living matter. The primordial earth, about 2600 million years ago provided suitable atmosphere for the origin of life. The earth during that period had many simple chemical compounds. More and more complex organic compounds were formed under the influence of **electric charges** and **Ultra violet rays**. The origin of complex organic molecules made the origin of life easier.

6. **J. B. S. Haldane's hypothesis**

Haldane was a British biochemist. He was the first to propose that life originated on earth, when the atmosphere was devoid of O₂ gas. Today's earth is surrounded by oxygen and its derivative ozone. The ozone layer protects earth by preventing the entry of harmful cosmic radiations. In 1929, he suggested that an atmosphere lacking O₂ would have no ozone layer. Hence ultra violet rays were freely entering earth's atmosphere. In a reducing atmo-

sphere this could have caused photochemical reactions resulting in the generation of organic molecules. These molecules gradually accumulated in the oceans as a **dilute 'soup'**.

7. Urey - Miller hypothesis

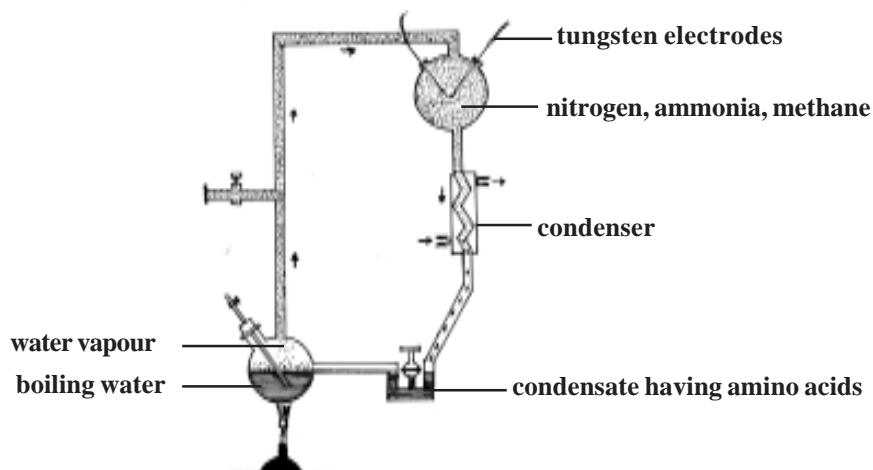

Fig.7.1.1 Spark-charge apparatus of Stanley Miller

U.S scientists Harold Urey and Stanley Miller in 1950's proposed and attempted to prove that amino acids can be synthesised outside living systems. They conducted experiments in which a gas mixture containing hydrogen, ammonia, methane and water vapour was subjected to electric spark. This trial yielded aldehydes, amino acids and carboxylic acids. They visualised the existence of a similar situation and happening of events resulting in a large scale accumulation of diverse biomolecules in the primordial earth. These chemical incidents could have paved the way for the origin of a cellular organisation.

8. Coacervation theory

Coacervates were considered to represent the protocell model. The tendency of biological polymers to form polymer-rich droplets called coacervates has been proposed by Oparin. He reported that coacervates are readily formed from aqueous suspension of proteins, polysaccharides and nucleic acids. Biochemical processes like enzyme action and electron transport can happen within a coacervate. Such systems were considered the forerunner of living cells.

7.2. Geological time scale

The oldest known rocks are about 3.8 billion (3800 million) years old. It corresponds to 38, 000, 000 centuries. According to Geologists and Geophysicists our planet earth is 4.7 billion (4,700 million) years old.

In this ancient time scale evidences showed that the first life originated 2.5 billion (2,500 million) years ago. Hence from the formative stage for nearly 2,200 billion years there was no life on earth. Such a period in earth's history is known as the **Azoic era** (2,200 to 5,000 billion years ago). Evidences show that during this era the earth was a hot sphere. Gradually the upper surface of the earth cooled down. It resulted in solidification and formation of rocks and rocky terrain. Further water molecules were formed resulting in accumulation of water and water reservoirs as water masses and land surface were established. These transformations provided a suitable condition for the origin of the first life.

Once the life originated and established, evolutionary changes took place. Changes happened in the structure, organisation and living methods of organisms, depending on natural surroundings and changes in natural surroundings. Thus fauna and flora started flourishing on earth. The water masses were fully exploited. Later land surfaces were invaded by plants and animals.

The Geological time succeeding Azoic Era, was dramatic and rich in life. This period is divided into three eras. These were significant periods in earth's history. Of these, the oldest era was the **Paleozoic era**. It ranged from 600 to 210 million years ago. Thus its duration was nearly 390 million years. This era saw the origin and adaptive radiation of sponges, starfishes, snails, insects, crabs, and terrestrialised amphibians and reptiles.

The Paleozoic era was followed by middle period named as **Mesozoic era**. This era ranged from 65 to 210 million years ago. Its duration was 145 million years. During this era, among animals the reptiles came to prominence. Hence this era is known as the **golden age of reptiles**. Further this era saw the origin and development of birds and reptiles.

The period ranging from 65 million years till date is named as the **Coenozoic era**. This era is characterised by rapid evolutionary changes in mammals. This era is known as the **Age of mammals**.

Geological time scale

A geological calendar has been formulated by assessing the age of rocks and rock sediments. Based on age, and events, the ancient period from

Era	Duration	Significance
Palaeozoic	600 - 210 m. years ago	“Cradle of ancient life”.
Mesozoic	210 - 65 m. years ago	“Golden age of reptiles”.
Cenozoic	65 - 1 m. years ago	“Age of mammals”.

earth’s history is formulated into eras-periods-epochs. Each division in the geological calendar is clearly identified and demarcated. Incidents pertaining to earth surface, plant and animals life are neatly recorded. The influence of geological and climatic changes on the life and the evolution of the living organism had been well analysed.

Era	Period	Epoch	Duration (million years ago)
CENOZOIC	Quaternary	Pleistocene	2 - 1
	Tertiary	Pliocene	7 - 2
		Miocene	26 - 7
		Oligocene	38 - 26
		Eocene	54 - 38
		Palaeocene	65 - 54
MESOZOIC	Cretaceous		130 - 65
	Jurassic		160 - 130
	Triassic		210 - 160
PALAEOZOIC	Permian		235 - 210
	Pennsylvanian		255 - 235
	Mississippian		275 - 255
	Devonian		315 - 275
	Silurian		350 - 315
	Ordovician		440 - 350
	Cambrian		600 - 440
	Precambrian		440 and before

Periods	Events
Quaternary - Pleistocene 2 - 1 m.years ago	Human evolution
TERTIARY - Pliocene 7 - 2 m. years ago	Rodents were successful Mammals increased
TERTIARY - Miocene 26 - 7 m. years ago	Prairies were formed Horses evolved. Carnivorous mammals were dominant
TERTIARY - Oligocene 38 - 26 m. years ago	Monkeys and apes originated
TERTIARY - Eocene 54 - 38 m. years ago	Horses originated
TERTIARY - Palaeocene 65 - 54 m. years ago	First flowering plants Mammals originated Dinosaurs disappeared.
CRETACEOUS 130 - 65 m.years ago	Dinosaurs became extinct
JURASSIC 160 - 130 m. years ago	Birds originated Modern bony fishes.
TRIASSIC 210 - 160 m. years ago	Dinosaurs evolved. Mammals originated.
PERMIAN 235 - 210 m. years ago	Origin of reptiles.
PENNSYLVANIAN 255 - 235 m. years ago	Land living insects.
MISSISSIPPIAN 275 - 255 m. years ago	Origin of Amphibia. Land living insects, Forests.
DEVONIAN 315 - 275 m. years ago	Age of fishes. Ferns and cycas.
SILURIAN 350 - 315 m. years ago	Jawed fishes originated
ORDOVICIAN 440 - 350 m. years ago	First vertebrates, Jawless fishes, Bryophytes
CAMBRIAN 600 - 440 m. years ago	Thallophytes, Arthropods, Molluscs, Echinoderms.
PRECAMBRIAN before 440 m. years ago	Protozoans, Poriferans and Annelids lived.

I. **Paleozoic era** :- This era produced revolutionary changes in the biosphere. Further this era saw the origin and the radiation of several groups of animals and plants that remained as the forefathers for the modern groups. Thus this era is known as the **Cradle of ancient life**.

1. **Cambrian period** :- (600 to 440 million years ago)

The period preceding cambrian is known as **Pre-cambrian period**. During precambrian time simple algae, protozoans, poriferans, annelids, were well established. Thus the cambrian started with the plants and animals that were successful during the precambrian period. During cambrian among plants thallophytes were well established. They diversified into various groups. (Chlorophyceae, Rhodophyceae etc.). Among animals the aquatic arthropods and echinoderms came to prominence. The fossils of such organism were obtained from several places.

2. **Ordovician period** :- (440 to 350 million years ago)

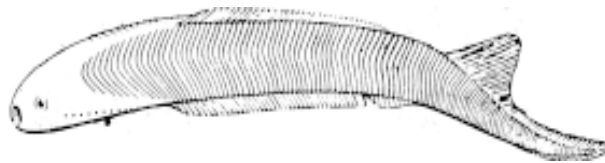

Fig.7.2.1 Jamoytins - an earliest jawless fish

This period was marked by formation of coral rocks and molluscs and echinoderms. Among plants the semi terrestrial bryophytes were getting established. Interestingly this period saw the origin of first vertebrates. These were the now extinct **agnatha**. (Jawless, armoured fishes). The origin of early vertebrates was the major event that happened in the evolution of animals. Among arthropods, the trilobites were more prominent during this period.

3. **Silurian period** :- (350 to 315 million years ago)

The oldest land plant originated in this period. These plants possessed conducting tissues. They colonised the land. Among invertebrates except for insects all others flourished. The corals diversified. Several coral islands were formed. Jawed fishes originated. The fishes developed scales and paired fins, for the first time jaws originated in fishes. Origin of paired fins and jaws is considered as major events in chordate evolution.

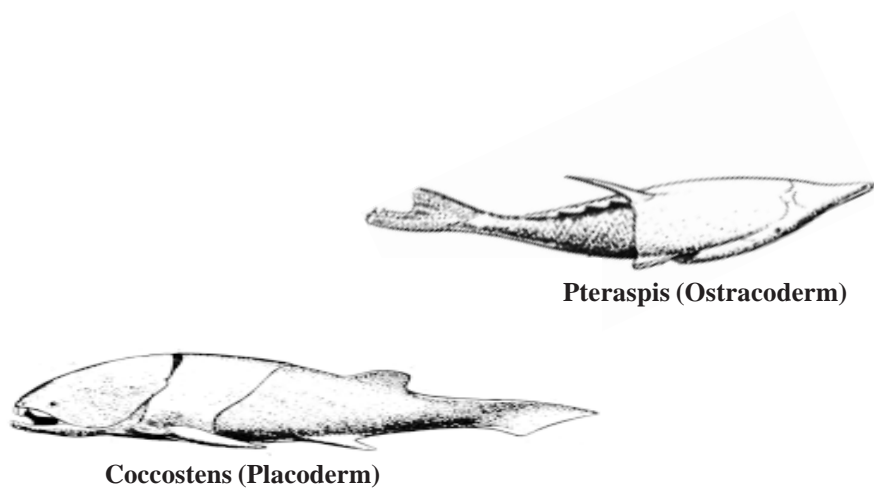

Fig.7.2.2 Ostracoderms - the early armoured, jawless fishes and Placoderms - the early jawed fishes.

4. Devonian Period :- (315 to 275 million years ago)

It is a significant period in the paleozoic era. During this period land living plants were more successful. The forests were filled with varieties of ferns and cycas. (non-flowering plants). Among aquatic animals fishes became dominant. They diversified by adapting themselves to live in various aquatic ecosystems. The forefathers of almost all modern fishes lived during this period. Due to these reasons this period is called as the **Age of fishes**.

5. Mississippian Period :- (275 to 255 million years ago)

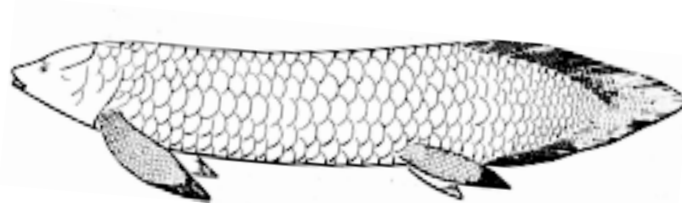

Fig.7.2.3 The Australian lung fish - Neoceratodus

Several changes happened to the land structure. There were massive upraising of land in several places. This resulted in the formation of several mountain ranges. Huge water bodies were broken into smaller lakes. These major changes on earth's surface were known as revolutions(eg. Caledonian revolution). Such changes were the cause for the origin of lungs in fishes. Lungs evolved for the purpose of living temporarily on land. It helped such fishes to find new water bodies. Such practises encouraged the origin of the

amphibians. The origin of land living amphibians were further increased by the proliferation of several land living insects.

6. **Pennsylvanian** :- (255 to 235 million years ago)

The land living forms became more successful during this period. There were huge forests of ferns and cycas. Due to geotectonic changes several forests got burried under the soil. Today's coal and petroleum are obtained from such resources only. Hence the Pennsylvanian and the earlier Mississippian were collectively known as **Carboniferous** (carbon bearing) **period**.

7. **Permian Period** :- (235 to 210 million years ago)

It was the last period in the Paleozoic era. This period was marked by extinctions of several older groups of animals and plants. Nearly 60% of the organism that survived at that time became extinct. Some of the amphibians dramatically laid land eggs (cleidoic eggs). Specifically the group of organisms that laid such eggs are identified as Seymouria. These are considered as inter-connecting links between amphibians and reptiles.

II. Mesozoic Era :-

This middle period in the history of life was marked by the prominence of land living forms. Among animals the reptiles became more dominant. They increased in size and in number. Hence this era is named as the **Golden age of reptiles**.

1. **Triassic Period** :- (210 to 160 million years ago)

For the first time fossils of turtles, crocodiles, and dinosaurs have been obtained from this period. Fossil evidences show that aquatic and flying reptiles thrived during this time. The mammals orginated from reptiles during this period.

2. **Jurassic Period** :- (160 to 130 million years ago)

There was a marked adaptive radiation among dinosaurs. They diversified into carnivorus and herbivorus forms. The first birds originated from the reptiles. The earlist bird thus originated is known as the **Archeopteryx**. The origin of birds was a major physiological change among animals. From a more common poikilothermic condition through feathers the birds became homeothermic.

The modern bony fishes were diversified into several groups.

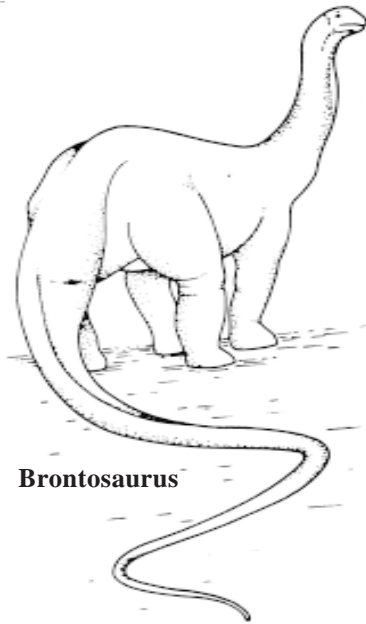

Brontosaurus



Tyrannosaurus

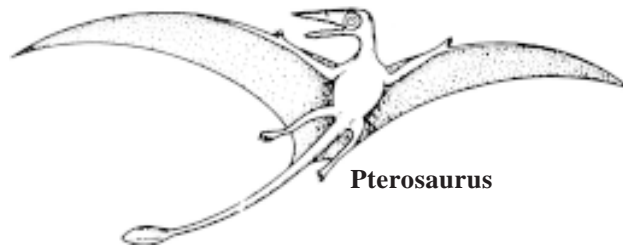

Pterosaur



Archaeopteryx



Fig.7.2.4 Mesozoic Birds and Reptiles

Cretaceous Period :- (130 to 65 million years ago)

The larger marine molluscs became extinct. The fossils of such organisms are available in places like Ariyaloor, of Tamil Nadu, today.

The Dinosaurs of the Mesozoic era abruptly became extinct during this period. Several reasons are given for the extinction of the dinosaurs. Fossils of dinosaurs were not obtained from later periods.

III. Cenozoic Era :- (65 million years ago till date)

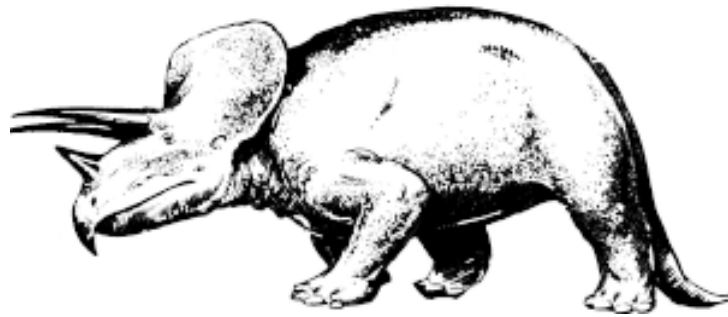

Fig.7.2.5 Triceratops - a horned dinosaur

Plenty of fossil of organisms belonging to this era had been obtained. All modern animals and plants were represented in these fossils. This era is subdivided into Tertiary and Quaternary periods. Further this era contains seven epochs. Through fossils we can trace the origin and evolution of independent groups of animals, camels and man.

1. Paleocene epoch :-

Modern placental mammals originated during this time.

2. Eocene Epoch :-

Ungulates originated. The ancestral form of modern horses lived during this epoch.

3. Oligocene epoch :-

Several animals with ancient characteristics became extinct. Modern mammalian families were established. The apes originated during this epoch.

4. Miocene epoch :-

Several varieties of grasses evolved in Europe and N. America. Thus large Prairies were formed. These changes encouraged the evolution of fast

running herbivorous mammals and their predators. Thus the carnivorous mammals came to prominence.

5. **Pliocene Epoch** :-

The priaries enlarged still further in several regions. The rodents became more successful. The mammals increased in number.

6. **Pleistocene epoch** :-

Several glaciations happened during this time. This epoch is popularly called the 'Ice age'. The evolution of horses and man reached the final stages during this period. The melting of ice that happened 1,500 years ago is considered as the last stage of this epoch. Today we are living in an inter-glacial Period.

7.3 **Fossils**

The fossils are the preserved remains of animals, plants or their parts found in various strata of earth. Fossils may be of entire organisms or a part which got buried, a mould or cast, foot prints or imprints of a leaf on a stone.

Fossilization :- Fossils can result by several methods. However these methods are purely accidental. There are many methods of fossilization.

1. **Petrifaction** :- It is the commonest method. In this method dead and buried organisms turn into stones. This is due to formation of sedimentary rocks under water. While the soft parts disappear due to decaying, hard parts get preserved due to mineralisation. The preservation happens in the original strata.

2. **Petrifaction of soft parts** :- Under certain conditions muscles and other soft organs may get mineralised and form rocky fossils. Several such plant fossils had been obtained.

3. **Preservation of foot prints** :- Moving animals on soft mud can leave foot prints. These prints, if left undisturbed, can get hardened and form rocky fossils. A study of such imprints can provide clues regarding the body form and characteristics of the extinct animal.

4. **Moulds and casts** :- Fossilized moulds are found in volcanic ashes. Several invertebrate fossils had been obtained as moulds. They provide details about the exact physical features of the animal.

5. **Fossilization in resins and amber** :-

Normally, insects get entangled in soft sticky secretions of trees called resin. The dried material can get fossilized. These fossils can even reveal the colour of the organism.

6. **Preservation in ice** :- Entire animals can get frozen and may be preserved in ice. In such fossils the body parts remain intact without change. Fossils of woolly mammoth from Siberia are classical fossils of this nature.

7. **Dating of fossils** :- The age of the fossils to a large extent can be assessed accurately, using radioisotope method. It is known that all elements exist as isotopes. Isotopes are atoms having slightly different atomic weights. e.g c^{12} and c^{14} . Some isotopes remain unstable. They undergo decay and release sub atomic α and β particles till they become more stable. Examples are

Uranium ²³⁸	□	lead ²⁰⁶
Potassium ⁴⁰	□	Calcium ⁴⁰ +argon ³⁹
Carbon ¹⁴	□	Carbon ¹²

The time required for the breakdown of half the given quantity of unstable isotope is called the half-life. The **half-life** of many isotopes is useful to assess the age of the rock accurately by measuring the ratio of **unstable : stable** nuclides. Eg. $c^{14} : c^{12}$ of the rock in which the fossil was collected.

Evolutionary significance of fossils

1. Fossils tell us the full story of evolution. Fossil studies reveal the course of evolution.
2. Through fossils the origin and evolution of specific groups of organisms can be understood e.g. Horse evolution.
3. Fossils provide us clues regarding climatic conditions of various prehistoric periods.
4. Study of fossils simplifies phylogenetic discussions.
5. Some fossils like woolly mammoth can provide vital clues regarding genetical make up.

Important fossils

Ichthyostega - interconnecting link between fishes and amphibians.

Seymouria - Interconnecting link between Amphibians and Reptiles.

Archaeopteryx - Ancestral form of birds

Dinosaurs - Extinct group of reptiles.

Hyracotherium - Early ancestor of horses.

7.3 Extinct animals-mass extinction

Extinction may be defined as the termination of a lineage without issue or abrupt disappearance of specific groups of organisms without leaving descendents. Extinctions are of two types namely true extinctions and pseudo extinction. In true extinctions a particular lineage totally disappears without any progeny or evolutionary descendents.

Pseudo extinction may also be called as **phyletic extinction** or **phyletic transformation**. In this type a group may disappear leaving descendents with evolutionary modifications. In horse evolution while the earliest ancestor **Eohippus** became extinct its descendent survived to produce the modern '**Equus**'. Extinctions can happen for the taxonomic groups such as a family or genus. Thus the extinction of dinosaurs as a group is a case of true extinction. Similar extinctions happened to trilobites.

The process of extinction is not always predetermined. It happens due to abrupt changes in environmental conditions or other biological factors. Through the use of computer models evolutionists can now examine the probability of extinction for large as well as small groups of organisms. From the fossil record it becomes evident that extinctions have occurred at regular intervals of time.

Pattern of extinction :-

Fossil record reveals a few patterns for extinction. Major groups of herbivorous vertebrates are more susceptible than the carnivorous vertebrates for extinction. Larger organisms easily became extinct. VanValen(1973) recorded a constancy in the rate of extinction in a number of groups. He explained this using 'Mac Arthur's law'. According to this law as every new adaptation encourages the survival of a possessor it also decreases a fitness of other related species of that area.

Causes of extinction :-

Even though extinctions are regular events in the history of earth they are caused due to specific reasons (1) A mass extinction may be due to drastic changes in the environmental conditions. (2) Any adaptive advance in one species decreases the fitness of all other species. Thus according to Red Queen's hypothesis you have to keep running pretty fast, just in order to stay in the same place. (3) Over specialisation to a specific situation may cause extinction.(ex. Antlers.) (4) The spread of an epidemic disease without any control can cause extinction. (5) An increase in the popu-

lation strength of herbivorous animals can cause rapid food shortage and cause extinction for several inter-related groups. (6) A sudden cosmic radiation can cause the death of large organisms. (7) A dust storm formed due to falling of a meteorite is commonly mentioned as a cause for the disappearance of dinosaurs.

In the recorded history of earth, extinctions of major groups of organisms were due to natural causes. By the end of Permian period of the Paleozoic Era, nearly 60% of the varieties then existed, became extinct. Similar large scale extinctions have been observed by the end of Mesozoic era and during Cenozoic time.

However the extinction of animals and plants during our time is mostly due to human interference. Thus the cause for the modern extinctions is invariably human activities. The realisation of such a cause led to starting of several international voluntary agencies to monitor and control extinctions. "The red-data book brought out regularly by W. W. F (World Wide Fund for nature, Formerly IUCN - International union for the conservation of nature and natural resources) provides a list of animals and plants that are endangered or have become extinct.

Self Evaluation

Part - A

- The resistant spores that led to origin of life on earth are named as
 - protozoans
 - cosmozoa
 - viruses
 - bacteria
- The proposal that living forms are animated forms of non-living matter was provided by
 - Empedocles
 - Thales
 - Lamarck
 - Aristotle
- The protocell model was formed of
 - coacervates
 - proteins
 - ozone
 - methane
- Mesozoic era is commonly referred to as
 - age of mammals
 - age of fishes
 - golden age of reptiles
 - cradle of ancient life
- The first vertebrates were included in the group
 - Amphibia
 - Agnatha
 - Carinata
 - Aves

5. The duration of cenozoic era was
- | | |
|---------------------------|-------------------------------|
| a) 210 to 65m years ago | b) 65m year ago to till date |
| c) 600 to 440 m years ago | d) 210m year ago to till date |
7. The coal and petroleum are obtained from the forests of
- | | |
|--------------------|--------------------|
| a) Devonian period | b) Mesozoic era |
| c) Cretaceous | d) Tertiary period |
8. The earliest ancestor of horses were
- | | |
|--------------|--------------|
| a) Eohippus | b) Equus |
| c) Seymouria | d) Dinosaurs |
9. Fossils of woolly mammoths were obtained from
- | | |
|------------|------------|
| a) Siberia | b) Sahara |
| c) Europe | d) Bavaria |
10. Identify the early ancestor of horses
- | | |
|------------------|------------------|
| a) Dinosaurs | b) Seymouria |
| c) Archaeopteryx | d) Hyracotherium |

Part - B

1. What was the nature of the primordial earth according to J.B.S Haldane ?
2. Why do we call the palaeozoic era as the cradle of ancient life.
3. What was Archceopteryx ?
4. What is 'ice age' ?
5. What is dating of fossils ?
6. What is the significance of seymouria ?
7. What is Mac Author's law ?
8. What is precambrian period ?

Part C

1. What is abiogenesis ?
2. Give an account of Urey-Miller hypothesis.
3. What is the evolutionary significance of fossils?
4. Give an account of the significant events of the Palaeozoic era.
5. Give an account of various epochs included in Cenozoic era.

Part D

1. Give an account of the Mesozoic era.
2. What is mass extinction ? Provide the causes for such extinctions.
3. Write an essay on fossils and methods of fossilization.